

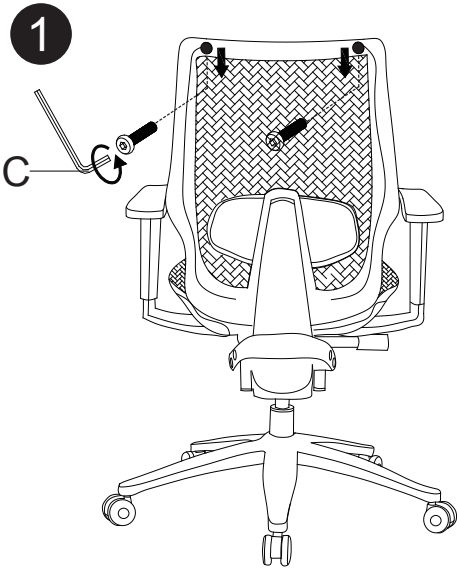

ASSEMBLY INSTRUCTIONS

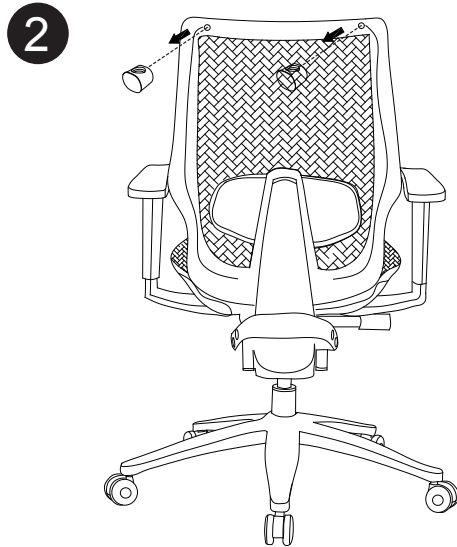

Loosen two screws underneath the top of the back frame.

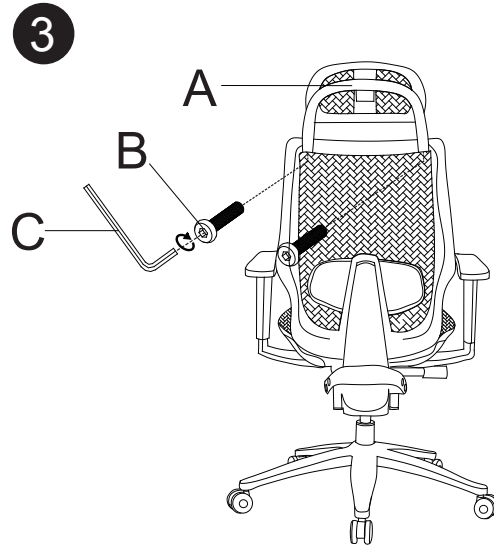

Take two caps off from the back frame.

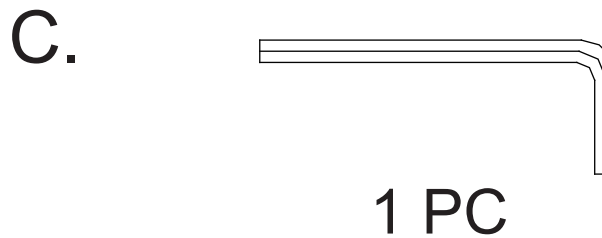
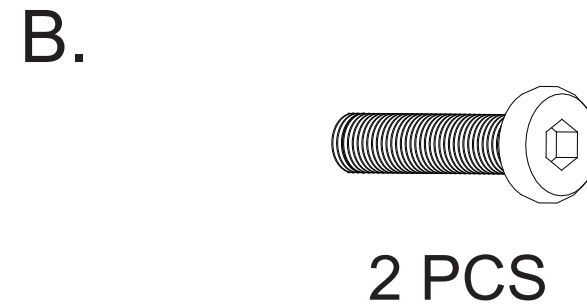
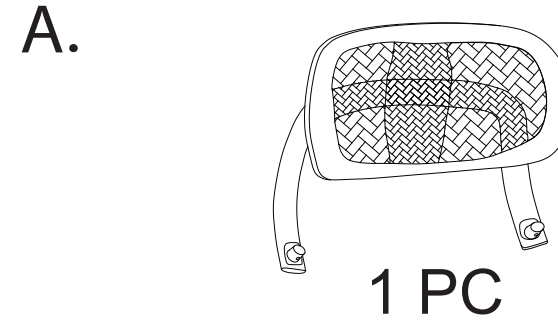
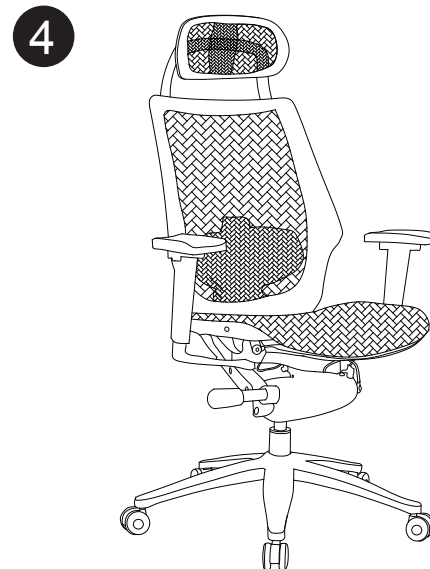

Model: ALE-KEHR18
Manufactured for/ Hecho para/ Fabriqué pour Alera®/ Essendant Co.,
One Parkway North, Deerfield, IL 60015 © 2015 Essendant Co.
Made in/ Hecho en/ Fabriqué en China
Product support and parts: 1-800-733-4000
Ayuda del producto y partes / Support technique et pieces