



**CLEANING AND CARE OF YOUR FURNITURE**

OUR FURNITURE IS MANUFACTURED USING A HIGH QUALITY MELAMINE LAMINATE WITH DURABLE PVC EDGING. THE MELAMINE SURFACE IS HIGHLY RESISTANT TO COMMON HAZARDS SUCH AS SCRATCHES, PEELING, MOISTURE AND HEAT. THERE MAY BE GLUE RESIDUE ON THE SURFACE OF THE FURNITURE REMAINING FROM THE MANUFACTURING PROCESS. IF YOU FIND RESIDUE, IT CAN BE EASILY REMOVED USING A SOFT CLOTH MOISTENED WITH ISOPROPYL (RUBBING ALCOHOL). FOR REGULAR MAINTENANCE OF YOUR FURNITURE, USE A SOFT CLOTH WITH A MILD CLEANING SOLUTION. NEVER USE ABRASIVES OR HARSH CHEMICALS TO CLEAN THE FURNITURE AS IT MAY HARM THE FINISH. LEVELING GLIDES CAN BE ADJUSTED TO COMPENSATE FOR UNEVEN FLOORS.

**LIMPIEZA Y CUIDADO DE SU MUEBLE**

NUESTROS MUEBLES SON FABRICADOS UTILIZANDO UN MELAMINA DE ALTA CALIDAD, LAMINADO CON CUBRECANTO DURABLE PVC. LA SUPERFICIE DE MELAMINA ES ALTAMENTE RESISTENTE A LAS AMENAZAS COMUNES, TALES COMO RAYONES, GOLPES, HUMEDAD Y EL CALOR. PUEDE HABER RESTOS DE PEGAMENTO EN LA SUPERFICIE DEL MOBILIARIO, RESTANTE DEL PROCESO DE FABRICACIÓN. SI SE ENCONTRARAN ESTOS RESIDUOS, SE PUEDEN QUITAR FÁCILMENTE CON UN PAÑO SUAVE, HUMEDECIDO CON ISOPROPÍLICO (ALCOHOL DE FROTAR). PARA REGULAR MANTENIMIENTO DE SUS MUEBLES, UTILICE UN PAÑO SUAVE CON UNA SOLUCIÓN DE LIMPIEZA. NUNCA UTILICE ABRASIVOS NI QUÍMICOS FUERTES PARA LIMPIAR EL MUEBLE YA QUE PODRÍA DAÑAR EL ACABADO. NIVELADORES AJUSTABLES PARA COMPENSAR LAS IRREGULARIDADES DEL SUELO.



**EASY ASSEMBLY  
RTA**  
No tools required

**Assembles  
in less  
than 10 minutes**

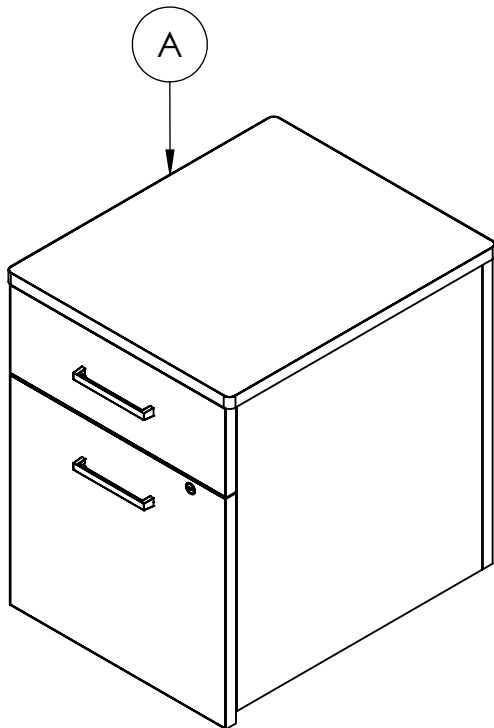

PART/PIEZA	QTY/CANT	ITEM/DESCRIPCIÓN
<b>A</b>	1	MAIN BODY / CUERPO DE ARCHIVERO
<b>B</b>	2	FRONT CASTER WITH BRAKE/ RODAJA CON FRENO
<b>C</b>	2	BACK CASTER/ RODAJA TRASERA
<b>D</b>	1	FRONT CASTER/ RODAJA FRONTAL
<b>E</b>	1	KEYS/ LLAVES

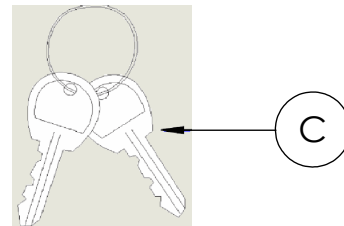
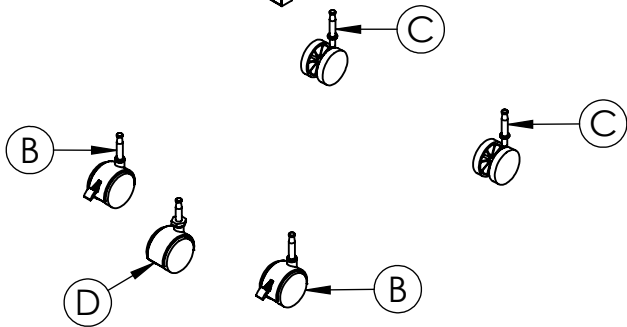

- 1** \*REMOVE THE CORNER PROTECTORS, OPEN THE BOX THAT CONTAINS THE CASTERS AND REMOVE.  
**1** \*RETIRAR LOS ESQUINEROS PROTECTORES, ABRIR LA CAJA QUE CONTIENE LAS RODAJAS Y SACARLAS.

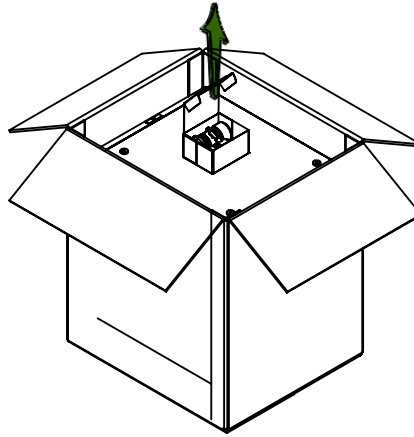
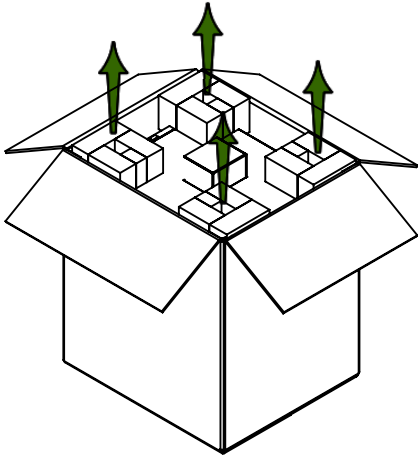

- 2** \*TWIST THE BACK CASTER (C) AND FRONT CASTER WITH BRAKE (B) INTO MAIN BODY PLATE AS SHOWN.  
**2** \*COLOCAR LAS RODASJAS TRASERAS Y LAS RODASJAS CON FRENO DENTRO DE LAS RONDANAS DEL CUERPO DEL ARCHIVERO.

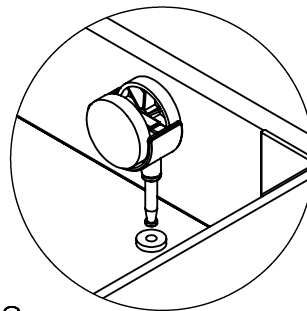
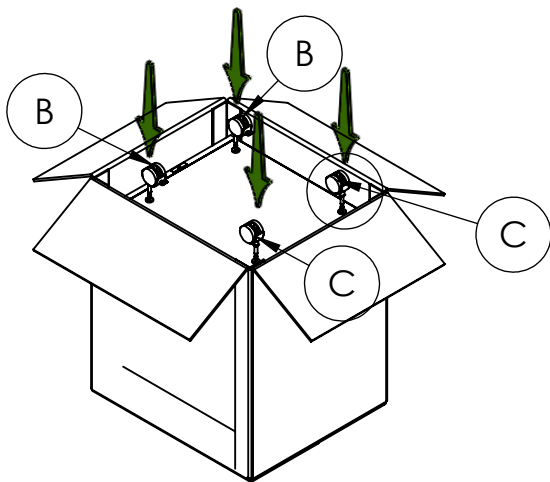

DETALLE  
ESCALA 1 : 5

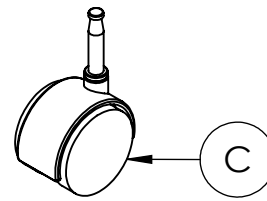
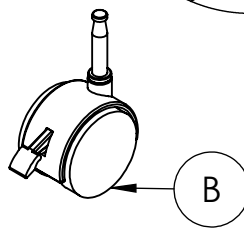

- 3** \*TWIST AND PUSH FRONT CASTER (D) INTO FRONT OF THE FILE BOTTOM PANELAS SHOWN.  
**3** \*GIRAR LA RODAJA FRONTAL EN LA TUERCA DENTRO DE LA PLACA DEL CAJÓN INFERIOR.

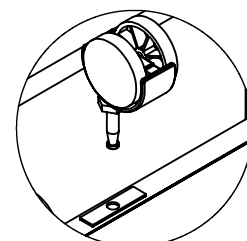
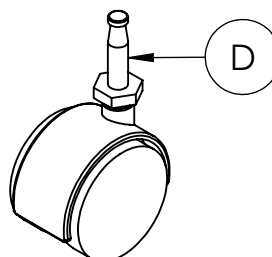
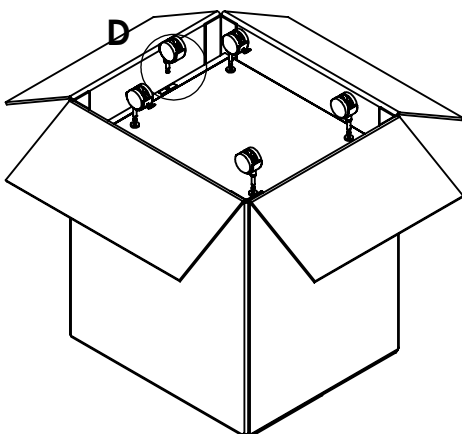

DETAIL D  
SCALE 1 : 5

4

\*TURN THE PEDESTAL FILE UPSIDE DOWN AND REMOVE THE BOX.

4

\*GIRAR EL ARCHIVERO Y RETIRAR LA CAJA.

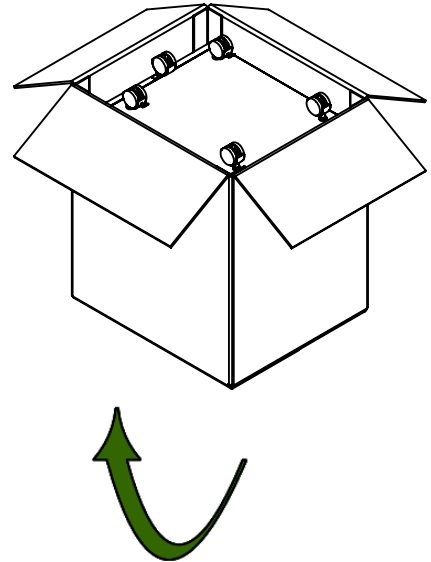
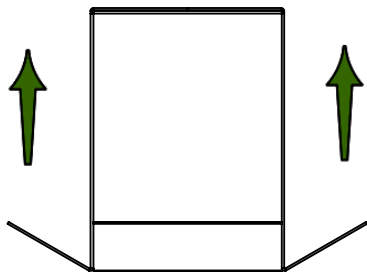

5

5

\*REMOVE THE KEYS (C) FROM THE HANDLE

\*RETIRAR LA LLAVES QUE SE ENCUNTRAN COLOCADAS EN LA JALADERA

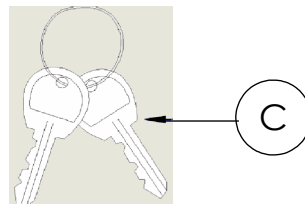
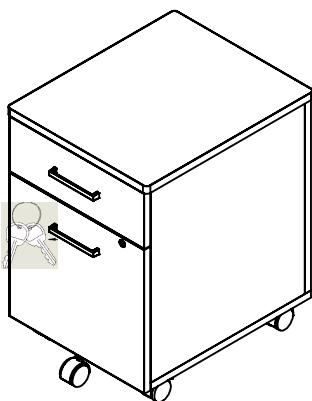

## LIMITED 5-YEAR WARRANTY

CREACIONES INDUSTRIALES S.A DE C.V (CRISA) WARRANTIES ITS PRODUCTS AGAINST MANUFACTURING, MATERIAL AND WORKMANSHIP DEEFCTS TO THE ORIGINAL PURCHASER FROM THE DATE OF PURCHASE FOR A PERIOD OF 5 YEARS. THE WARRANTY IS SUBJECT TO THE PRODUCTS STILL BEING OWNED BY THE ORIGINAL PURCHASER AND INSTALED, USED AND MAINTAINED IN ACCORDANCE WITJ PRODUCT INSTRUCTIONS AND WARNINGS.

### WARRANTY DURATION:

- 1) **5 YEARS:** Desk, hutches, panels and file cabinets
- 2) **1 YEAR:** Plastic caps, locks, hinges, fabric, casters, wood seats and accessories. Sienna chair A501.

### LIMITATIONS:

- 1) Damage caused by the carrier-in-transit is handled under separate terms as defined by the carrier.

### EXCLUSIONS:

- 1) Damage resulting from improper product installation, assembly or disassembly.
- 2) Normal wear and tear as expected over the course of ownership.
- 3) Modifications or attachments to the product not approved by CRISA.
- 4) Product used for rental purpose.

### WARRANTY WILL NOT BE APPLICABLE IN THE FOLLOWING CASES:

- 1) Products that were not installed, used or routinely and properly maintained in accordance with product instructions and warnings.
- 2) Product used in different conditions than intended.
- 3) Product not assembled according to the provided written instructions.
- 4) Product changed or repaired by non CRISA authorized personnel.
- 5) Defects occurring after the purchase by natural disasters, product modification, intentional damage, accident, misuse, abuse, negligence or exposure to the elements.
- 6) Damages caused by third party carriers other than Creaciones Industriales S.A DE C.V

TO THE EXTENT ALLOWED BY LAW, CRISA MAKES NO OTHER WARRANTY, EITHER EXPRESS OR IMPLIED, INCLUDING ANY WARRANTY OF MERCHANTABILITY OR FITNESS FOR A PARTICULAR PURPOSE. CRISA WILL NOT BE LIABLE FOR ANY CONSEQUENTIAL OR INCIDENTAL DAMAGES.

#### Notice to Purchaser for home or personal use:

Federal law does not permit the exclusion of certain implied warranties for consumer products. Therefore, if you are purchasing this product for home or personal use, the exclusion of implied warranties noted in the above paragraph does not apply to you. Some states do not allow the exclusion or limitation of incidental or consequential damages, so the above limitation or exclusion may not apply to you. This warranty gives you specific legal rights, and many also have other rights which vary from state to state.

## WARRANTY PROCEDURE

- 1) Your Linea Italia reseller will work with CRISA in supporting warranty request.
- 2) Defects must be reported immediately when discovered. Please contact Reseller from whom the product was purchased and provide SKU#, invoice # or date of manufacture from the product.
- 3) Provide a detailed description of the problem with photos, lot number and invoice number. It is important not to remove any labels from the product as they provide important traceability information.
- 4) A customer service representative or CRISA will determine whether to provide replacement parts, authorize repair or replace the product provided CRISA affirms that the products in question is eligible under the conditions of the warranty as stated above.
- 5) CRISA will review the defect and determine whether it is related to material or workmanship. If the defect is not related to manufacturing, cost of replacement parts and shipping will be the customer's responsibility.

CREACIONES INDUSTRIALES S.A DE C.V RESERVES THE RIGHT TO CHANGE PRODUCTS, TECHNICAL SPECIFICATIONS, ACCESSORY COMBINATIONS, COLORS IMAGES AND DATA ANY TIME WITHOUT NOTICE.



# California 93120

Compliant for Formaldehyde Phase 2

*The California Air Resources Board (CARB) approved an Airborne Toxic Control Measure (ATCM) to reduce formaldehyde emissions from composite wood products including hardwood, medium density fiberboard and particleboard. These finished goods are low in formaldehyde emissions and comply with the ATCM.*

**Creaciones Industriales S.A de C.V**

Jose Ma. Chavez N. 643, CP.20000  
Aguascalientes, Ags. Mexico