

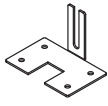



<p>A</p>  <p>Up Wall Bracket 1 Pc</p>	<p>B</p>  <p>Bottom Wall Bracket 1 Pc</p>	<p>C</p>  <p>Plug 1 Pc</p>	<p>D</p>  <p>Screw M8 x 35 1 Pc</p>	<p>E</p>  <p>Screw M4 x 25 10 Pcs</p>	<p>F</p>  <p>Wall Anchor 10 Pcs</p>
---	---	--	---	---	---

STEP 1





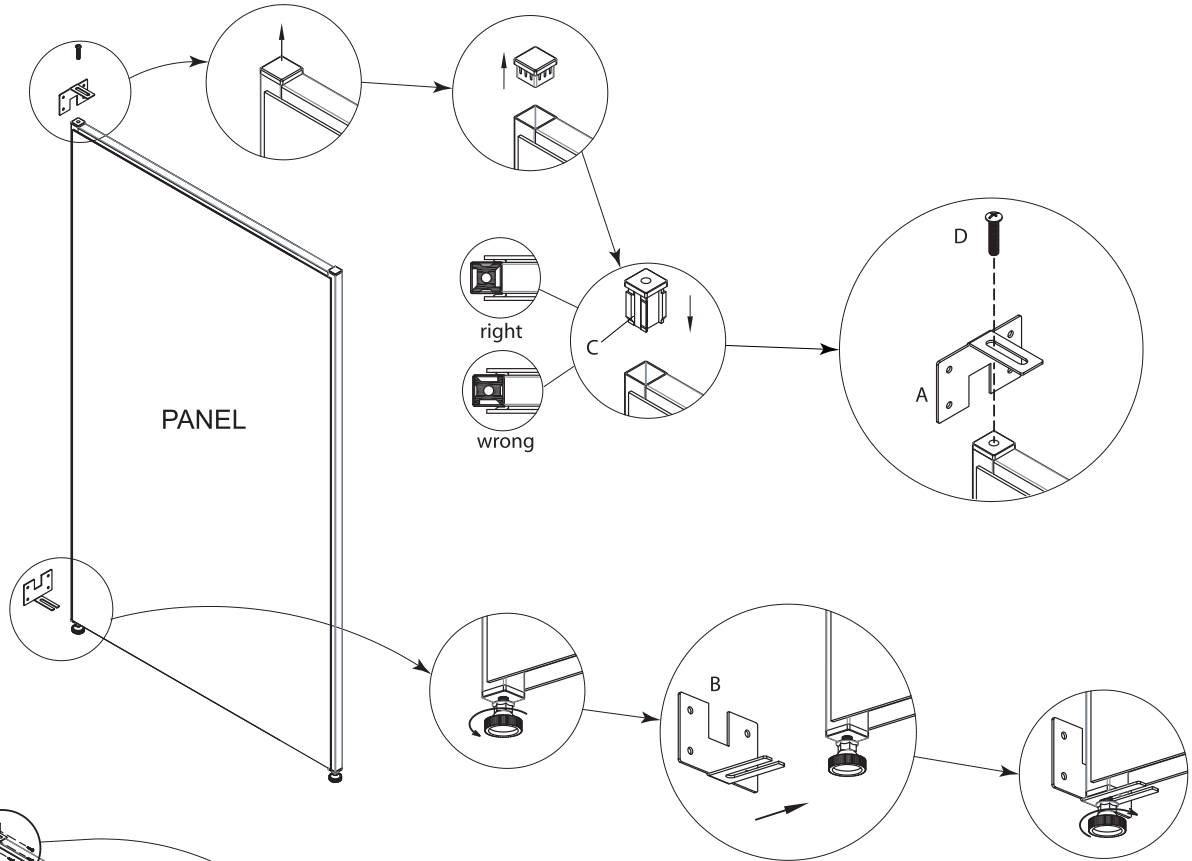
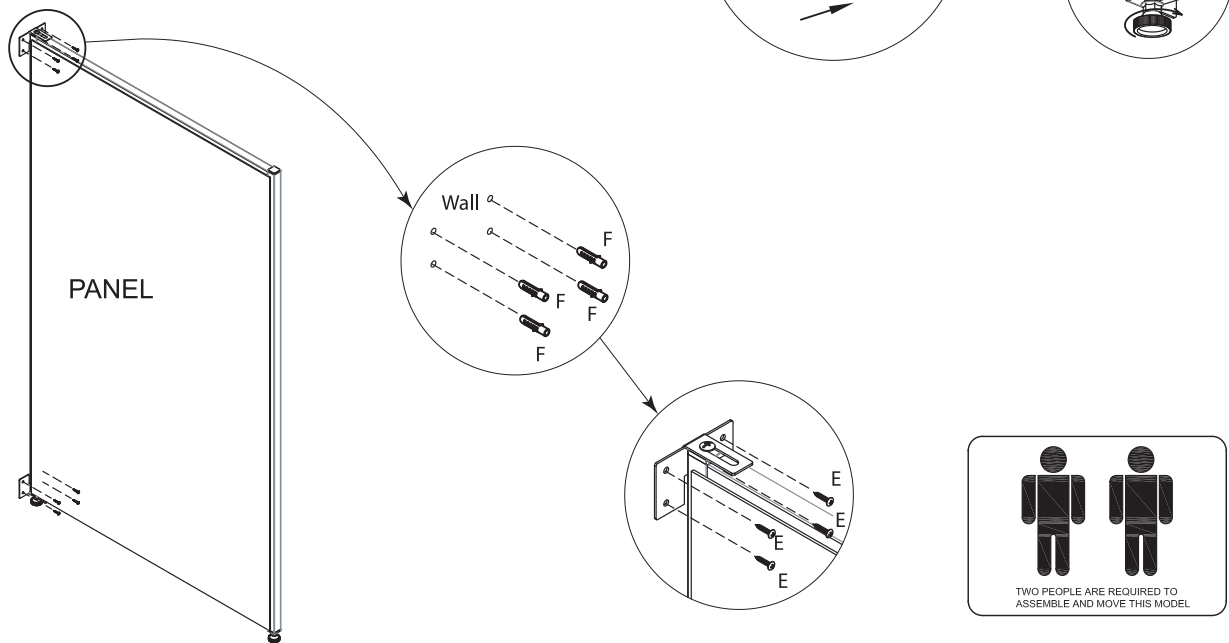

STEP 2

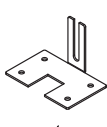

IMPORTANT NOTE:

- Place all laminated parts on a clean and smooth surface such as a rug or carpet to avoid the parts from being scratched.
- Check to make sure that you have all parts and hardware.
- Remove all wrapping materials, including staples and packaging straps before your start to assemble.
- Do not tighten all screws/bolts until pieces are completely assembled.
- Keep all hardware parts out of children's reach.
- It is recommended for 2 persons to complete this assembly.

<p>A</p>  <p>Support mural supérieur 1 Pc</p>	<p>B</p>  <p>Support mural inférieur 1 Pc</p>	<p>C</p>  <p>Bouchon 1 Pc</p>	<p>D</p>  <p>Vis M8 x 35 1 Pc</p>	<p>E</p>  <p>Vis M4 x 25 10 Pcs</p>	<p>F</p>  <p>Taquet mural 10 Pcs</p>
---	---	---	---	---	--

ÉTAPE 1

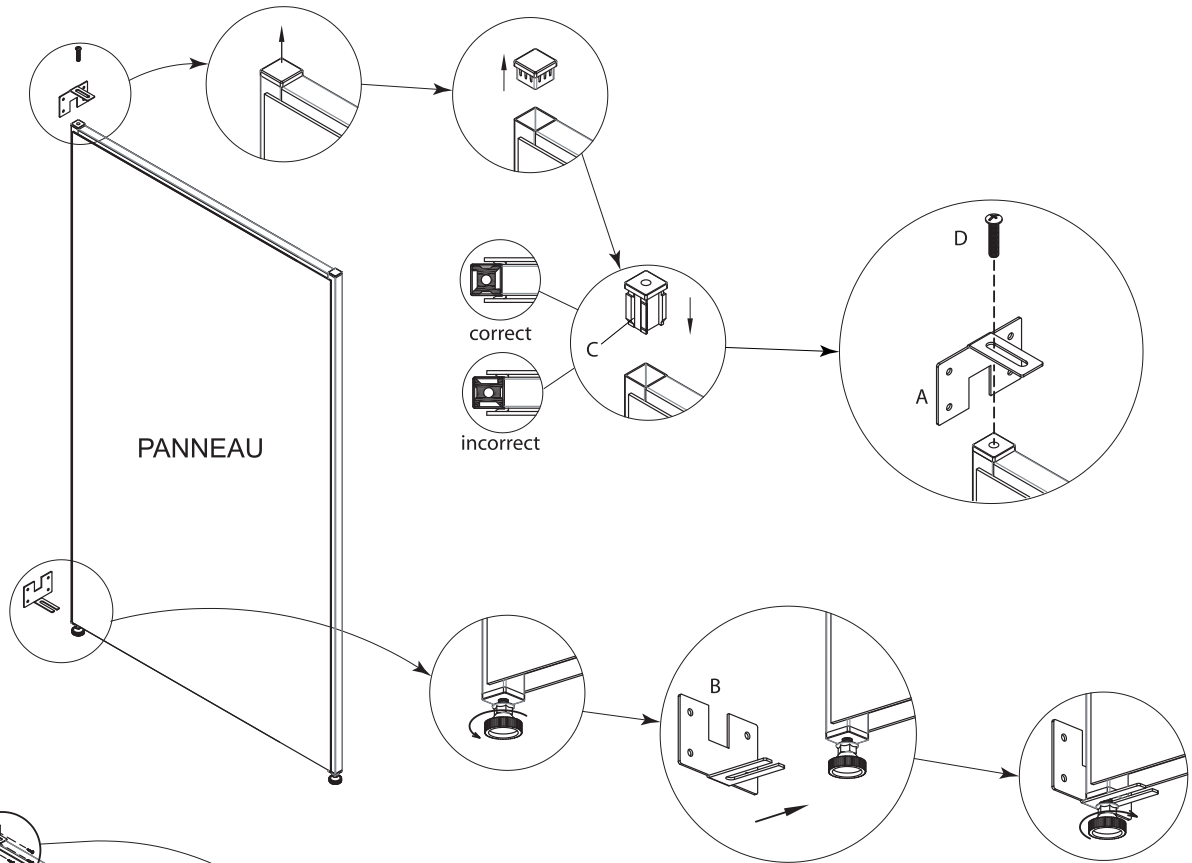



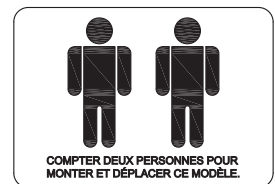
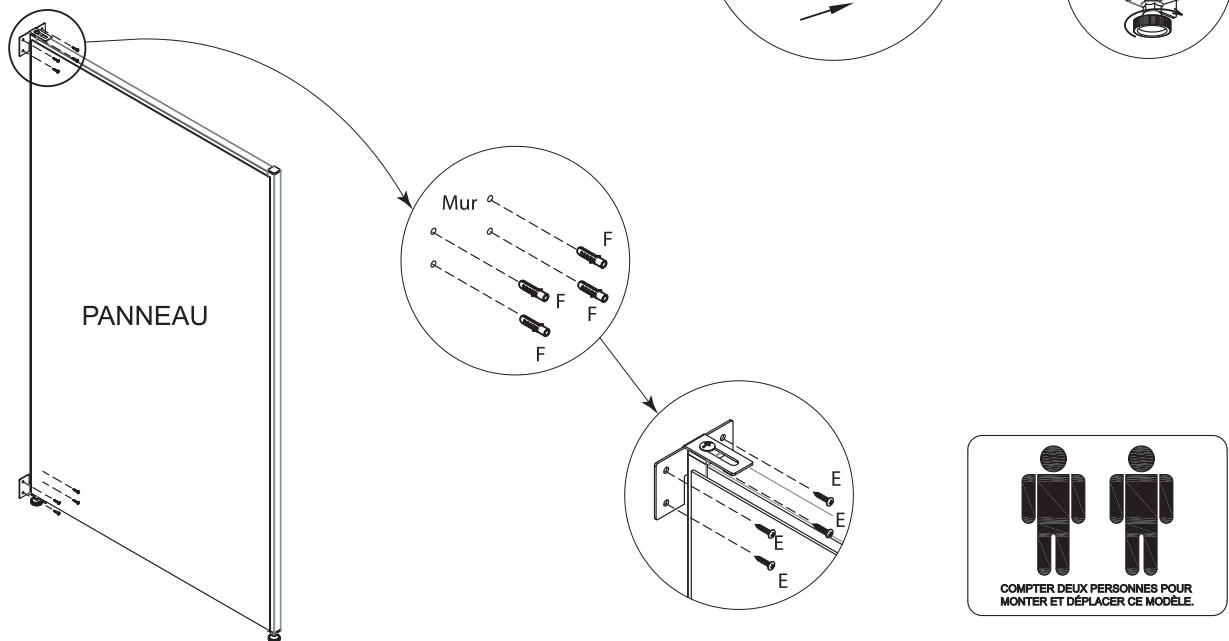

ÉTAPE 2

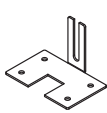

REMARQUE IMPORTANTE :

- Placer toutes les pièces contrecollées sur une surface propre et lisse, comme de la moquette ou un tapis, pour éviter qu'elles soient éraflées.
- S'assurer d'être en possession de toutes les pièces et de toute la quincaillerie
- Retirer tout matériau d'emballage, y compris agrafes et sangles, avant de commencer le montage.
- Ne pas serrer toutes les vis/tous les boulons avant que l'ensemble ne soit terminé
- Toute la quincaillerie doit rester hors de portée des enfants.
- Il est recommandé de travailler à 2 pour effectuer ce montage.

<p>A</p>  <p>Escuadra de pared (arriba) 1 pza.</p>	<p>B</p>  <p>Escuadra de pared (abajo) 1 pza.</p>	<p>C</p>  <p>Taco 1 pza.</p>	<p>D</p>  <p>Tornillo M8 x 35 1 pza.</p>	<p>E</p>  <p>Tornillo M4 x 25 10 pzas.</p>	<p>F</p>  <p>Sujetador de pared 10 pzas.</p>
--	---	--	--	--	--

PASO 1

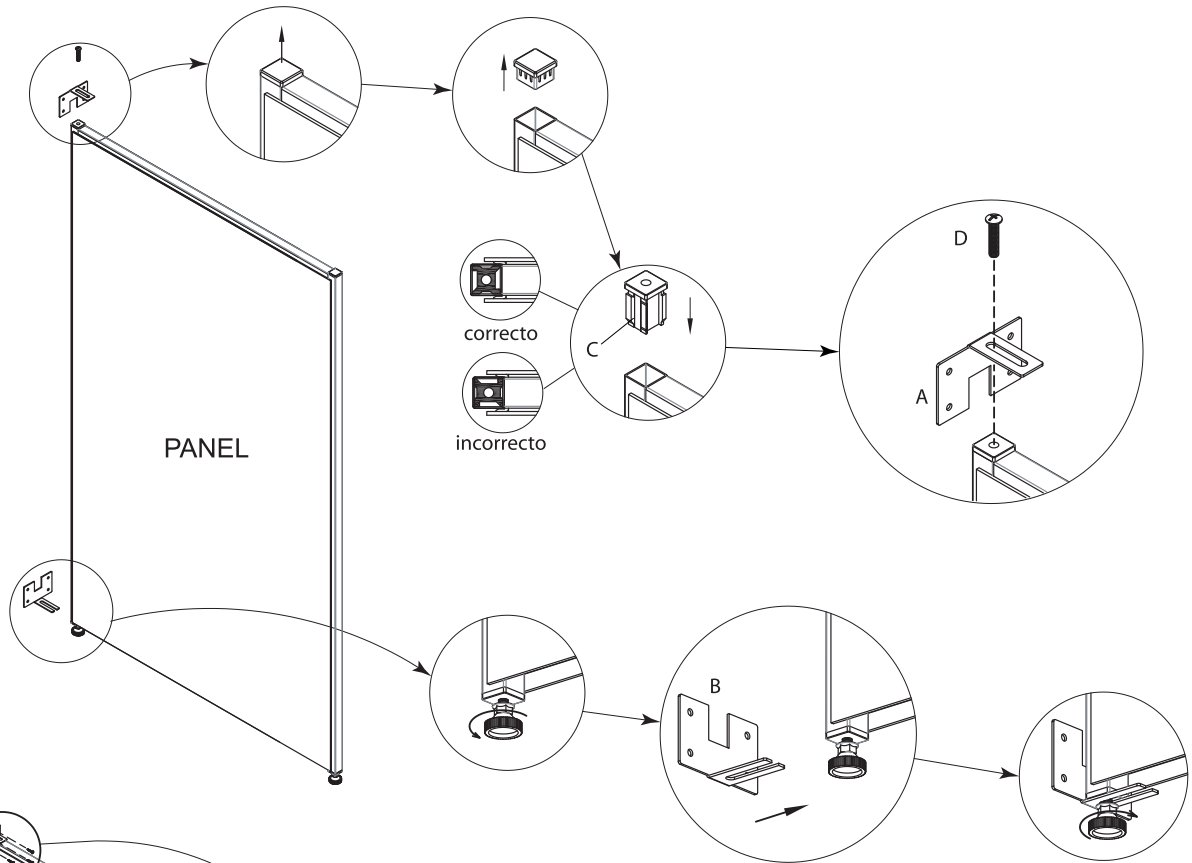

PASO 2

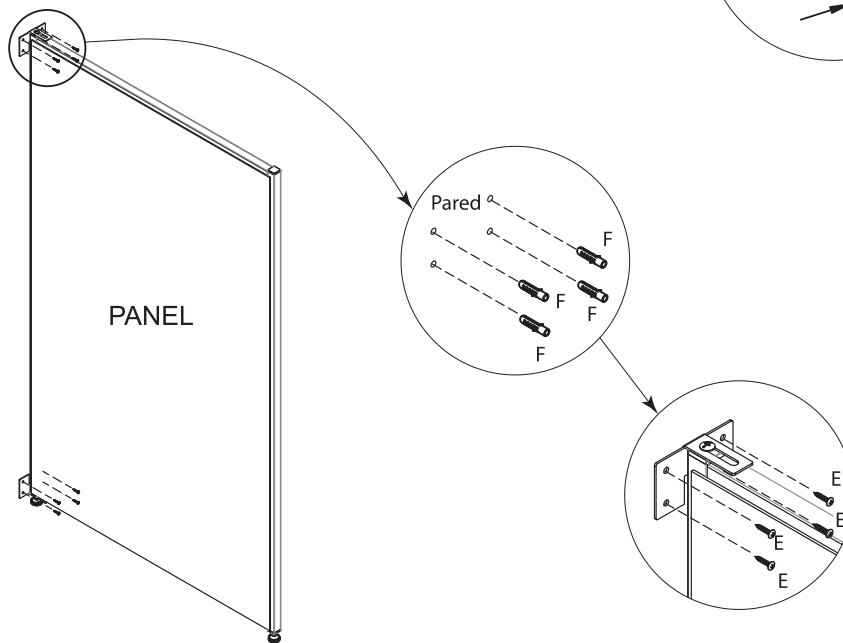

NOTA IMPORTANTE:

- Coloque todas las partes laminadas sobre una superficie limpia y uniforme (como un tapete o la alfombra) para evitar que se rayen.
- Asegúrese de tener todas las partes y la ferretería.
- Antes de empezar a ensamblar, retire todos los materiales de empaque, incluyendo grapas y cintas.
- No apriete todos los tornillos y pernos sino hasta haber ensamblado todas las piezas.
- Mantenga toda la ferretería fuera del alcance de los niños.
- Se recomienda que dos personas realicen el ensamble.

Instructions

If you are missing parts or have other concerns, please email Lorell@sprich.com or fax: 404-472-9063.

Please provide the following information:

1. Full Name
2. Physical Address – do not include P.O. Box as our carriers cannot deliver to a P.O. Boxes
3. Phone Number
4. Model Number
5. Part Number
6. Invoice #
7. Date of Purchase

Note: Our policy is to send all parts requests normal ground transportation, if your requirements are to have these parts via overnight/next day, please provide your designated carrier and account number. Replacement panels are not available. If damaged has occurred during shipment, please return the entire unit to place of purchase for credit and replacement. Original Invoice may be required.

Before you begin:

Open, identify and count all parts prior to assembly. Lay out the parts on a non-abrasive surface such as carpet or blanket.

Instructions

Veuillez nous faire parvenir un courriel à lorell@sprich.com ou un fax à : 404-472-9063, s'il vous manque des pièces ou que vous éprouvez d'autres inquiétudes.

Veuillez fournir l'information suivante :

1. Nom complet
2. Adresse physique – ne donnez pas votre boîte postale car nos livreurs ne peuvent pas livrer à une boîte postale
3. Numéro de téléphone
4. Numéro de modèle
5. Numéro de pièce
6. # de facture
7. Date de l'achat

Note: Notre politique est de livrer toutes les demandes de pièces par la voie terrestre; prière de fournir le nom de votre transporteur ainsi que votre numéro de compte si vos exigences sont d'avoir ces pièces livrées pendant la nuit/le lendemain. Des panneaux de remplacement ne sont pas disponibles. Si des dommages sont survenus durant le transport, prière de retourner l'unité entière à l'endroit de l'achat pour un crédit et un remplacement. La facture originale peut être exigée.

Avant de commencer:

Ouvrez, identifiez et comptez toutes les pièces avant de procéder à l'assemblage. Disposez les pièces sur une surface non-abrasive telle un tapis ou une couverture.

Instrucciones

Si le faltan partes o tiene alguna pregunta, escriba un mensaje de correo electrónico a Lorell@sprich.com o envíe un fax al 404-472-9063.

Recuerde incluir la siguiente información:

1. Nombre completo
2. Domicilio. No incluya apartado postal debido a que nuestros distribuidores no pueden hacer entregas a un apartado postal.
3. Número telefónico
4. Número de modelo
5. Número de parte
6. Número de factura
7. Fecha de compra

Nota: Nuestra política establece enviar todas las partes solicitadas vía terrestre. Si sus requisitos incluyen tener estas partes con un envío nocturno o al día siguiente, sírvase proporcionar su transportista asignado y número de cuenta.

No se cuenta con tableros de repuesto. Si la unidad sufrió algún daño durante el envío, regrésela completa a donde la adquirió para que le reembolsen su pago y se la reemplacen.

Se le podría solicitar su factura original.

Antes de iniciar:

Abra, identifique y cuente todas las partes antes del ensamble. Coloque todas las partes en una superficie no abrasiva, como una alfombra o sábana.