



Art. Nr.: **L-145**

Product Physical Specifications

BCI	Model	Voltage (V)	Dimension (mm)				Quantity(Liters)	Weight(kg)
			Length	Width	Height	Total Height	Electrolyte	Battery
GC2H	L-145	6	259	179	264	297	6.3	33.0

Electrical Specifications

Type	Capacity Minutes		Capacity Amp-Hours(AH)	
	@25 Amps	@75 Amps	@5Hr	@20Hr
L-145	530	145	215	260

Terminal Configurations

WNT	Wing Nut Terminal
	Terminal Height mm(Inches) 33(1.29) Torque Value kgf*cm(Nm) 110-120(10.8-11.8) Bolt 5/16"

EUT	Embedded Universal Terminal
	Terminal Height mm(Inches) 27.4(1.08) Torque Value kgf*cm (Nm) 110-120(10.8-11.8)

Battery Dimensions

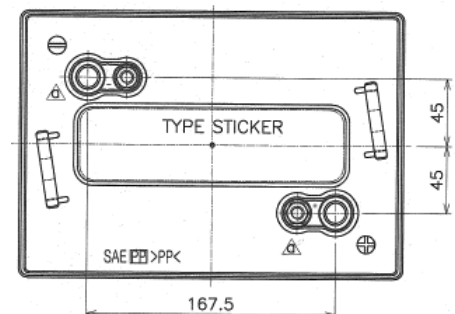
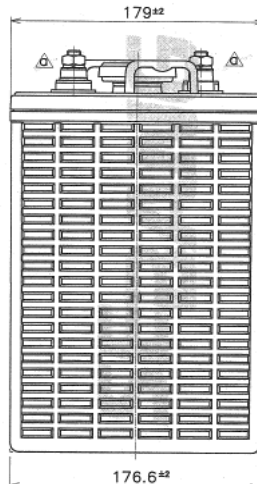
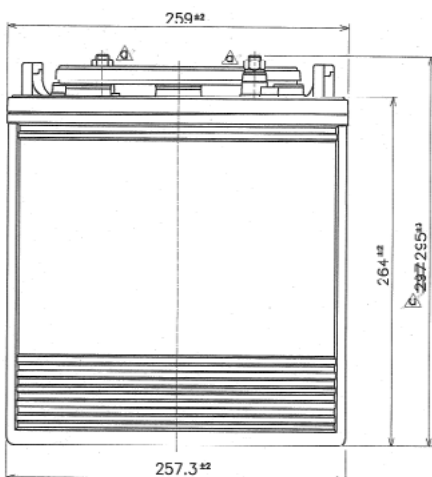

Self Discharge Data

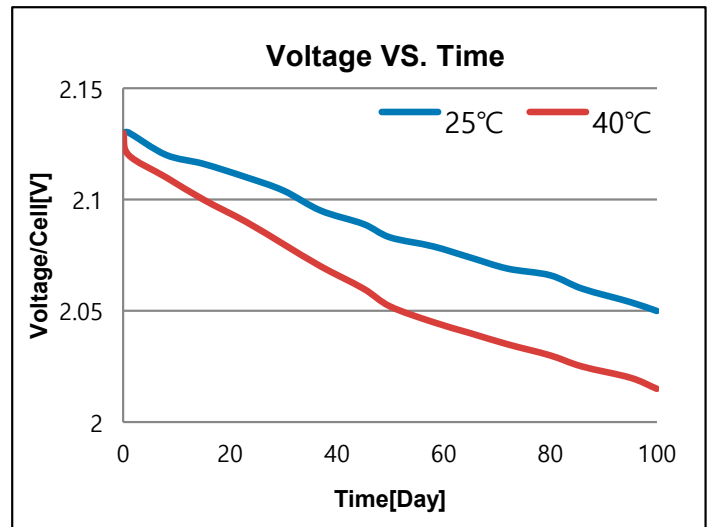
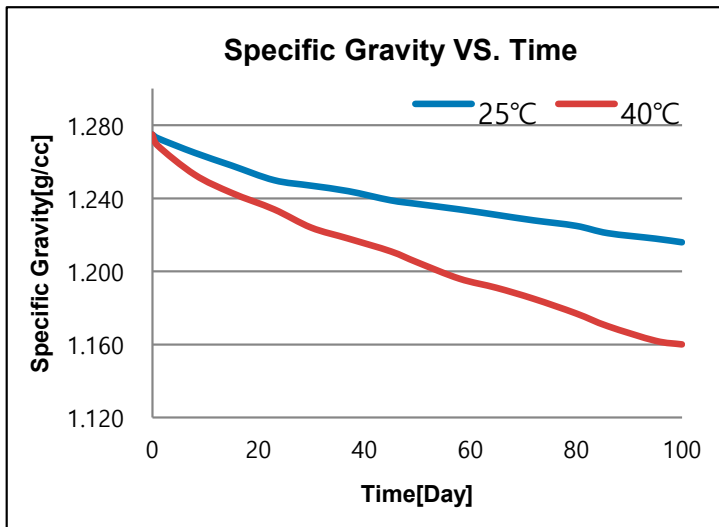

Capacity By Discharge Current

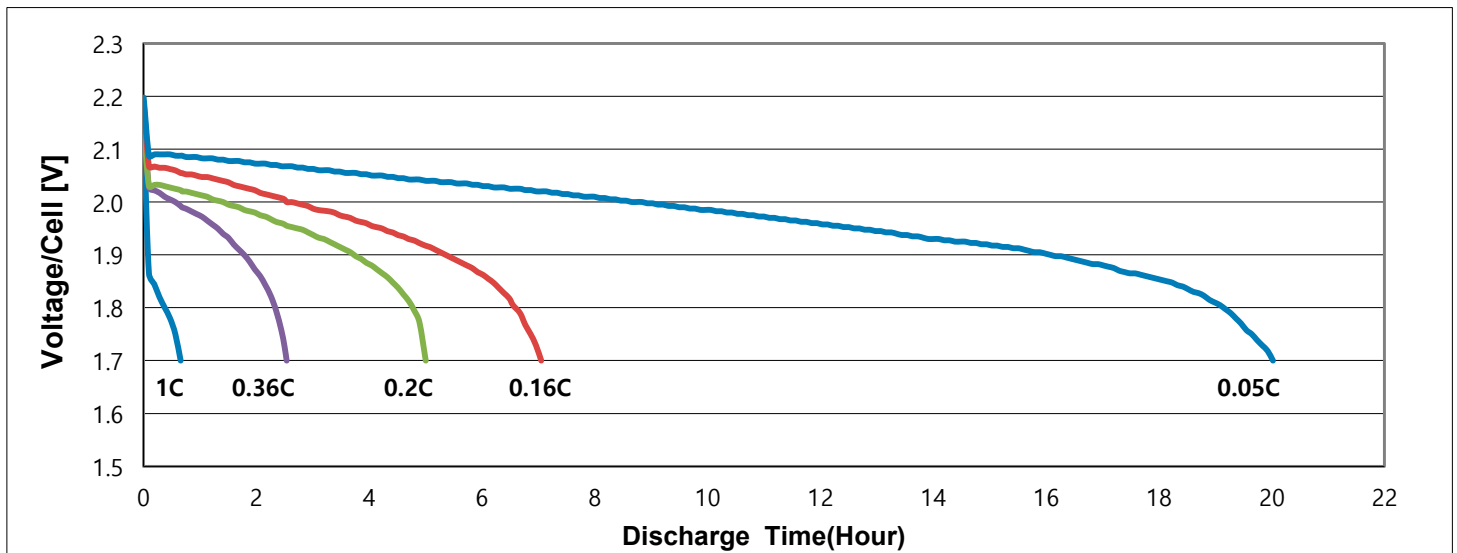

Cycle Service Life : BCIS-06 [DOD 100% _ 27°C]

