

Maßtoleranz: ± 2 mm

Art. Nr.: **SB.0661700**

Bezeichnung: **0661700**

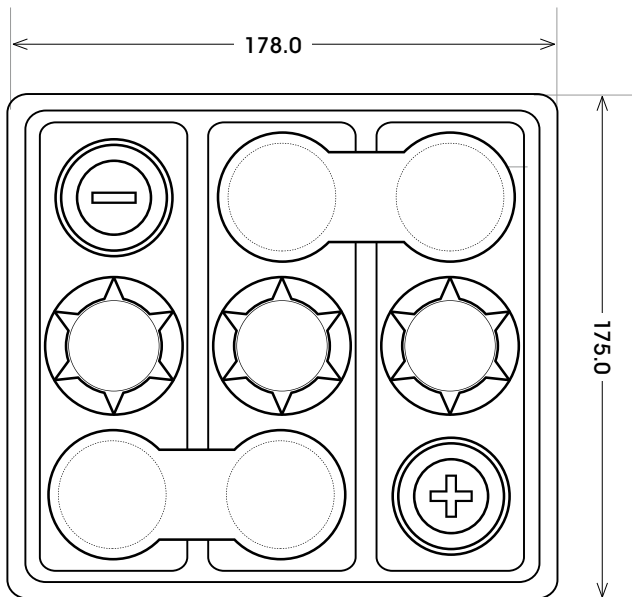
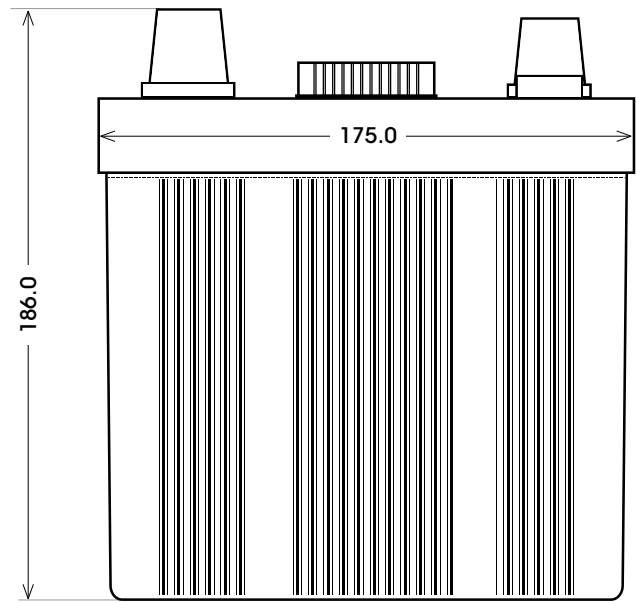
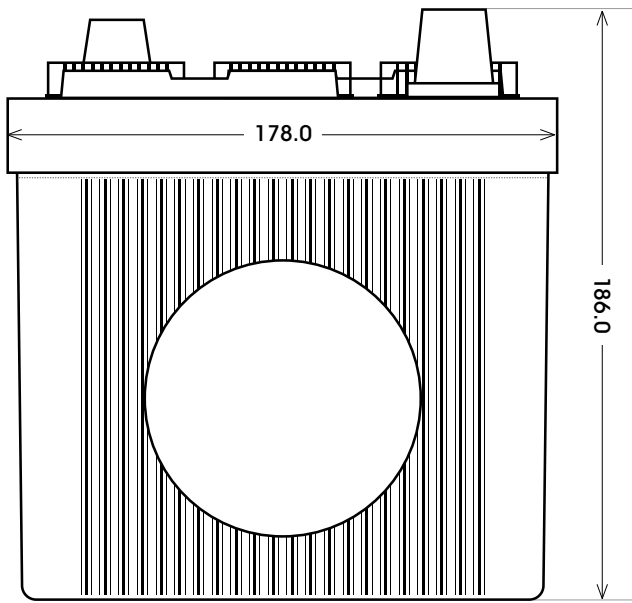

Technologie	Blei-Kalzium (Pb/Ca)
Spannung	6 V
Kapazität	66 Ah
Kälteprüfstrom	360 A/EN
Länge	178 mm
Breite	175 mm
Höhe	186 mm
Bodenleiste	B00
Schaltung	0
Polart	1
Gewicht	9.0 kg
Ausführung	trocken vorgeladen

Bodenleiste **B00**

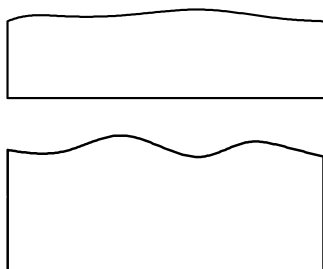

Schaltung **0**



Anschlusspole **1**

