

Art. Nr.: **SB.5664133**

Bezeichnung: **56641**

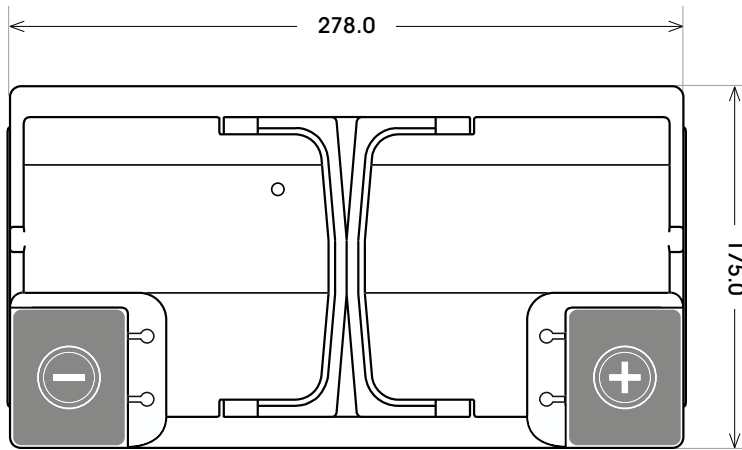
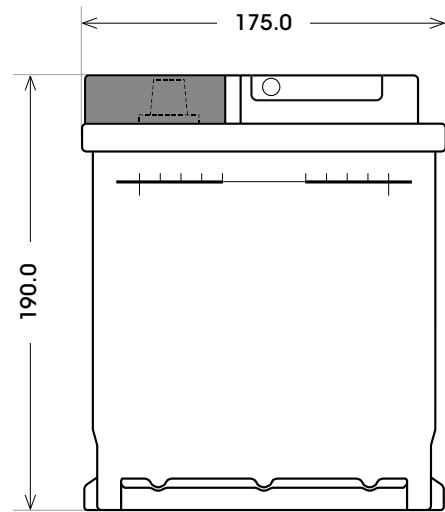
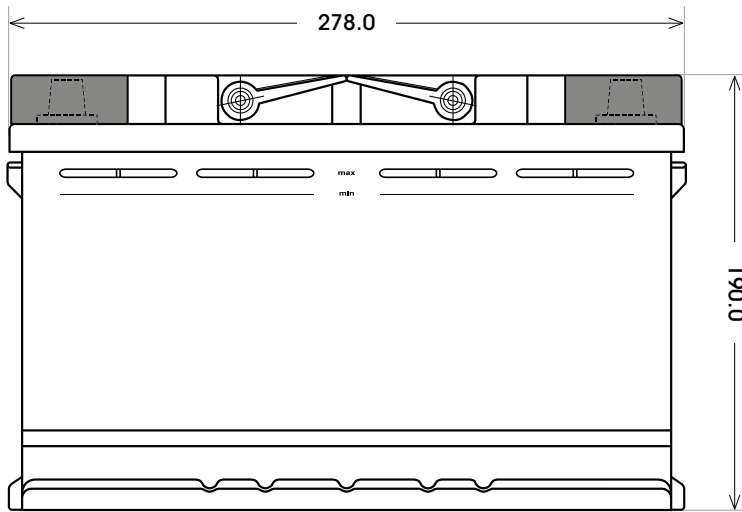

Technologie	Nassbatterie
Spannung	12 V
Kapazität	66 Ah
Kälteprüfstrom	510 A/EN
Länge	278 mm
Breite	175 mm
Höhe	190 mm
Bodenleiste	B13
Schaltung	0
Polart	1
Gewicht	16.7 kg

Bodenleiste **B13**

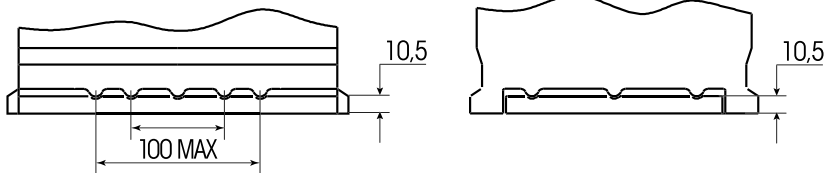

Schaltung **0**

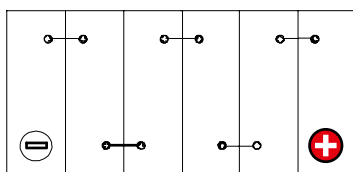

Anschlusspole **1**

