

Art. Nr.: **SB.5455133**

Bezeichnung: **54551**

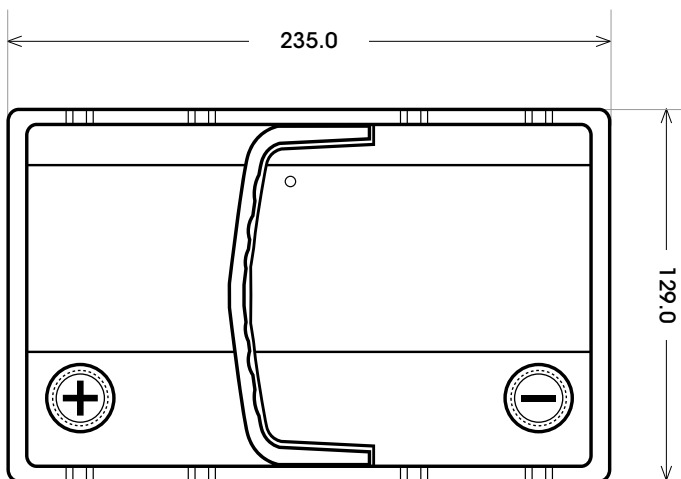
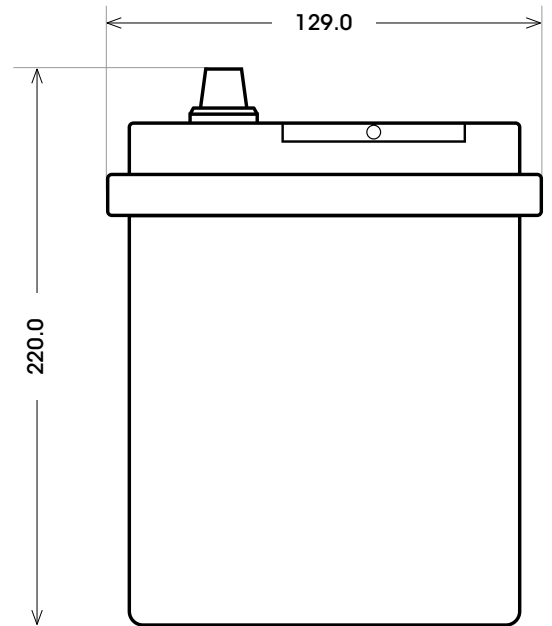
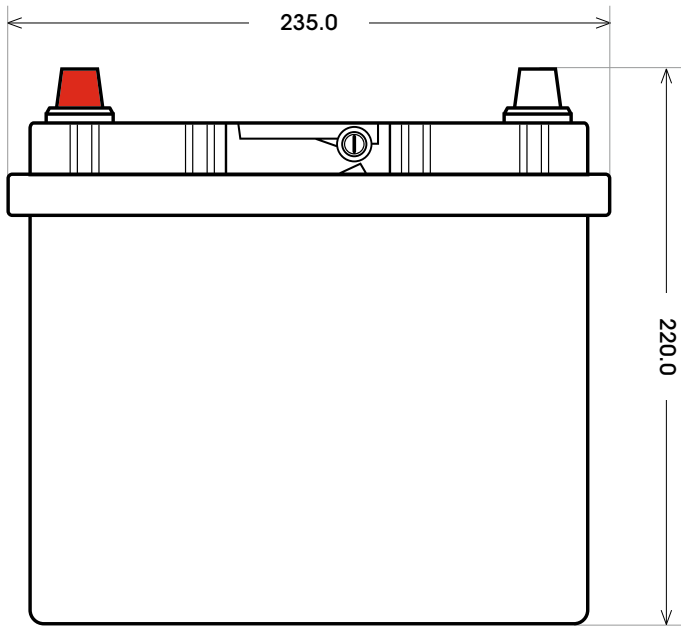

Technologie	Nassbatterie
Spannung	12 V
Kapazität	45 Ah
Kälteprüfstrom	300 A/EN
Länge	235 mm
Breite	129 mm
Höhe	220 mm
Bodenleiste	B00
Schaltung	1
Polart	3
Gewicht	11.7 kg

Bodenleiste **B00**



Schaltung **1**

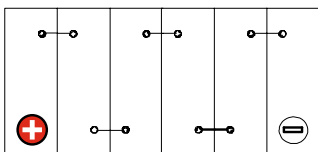

Anschlusspole **3**

