

Art. Nr.: **SB.ASIA09**

Bezeichnung: **ASIA 09**

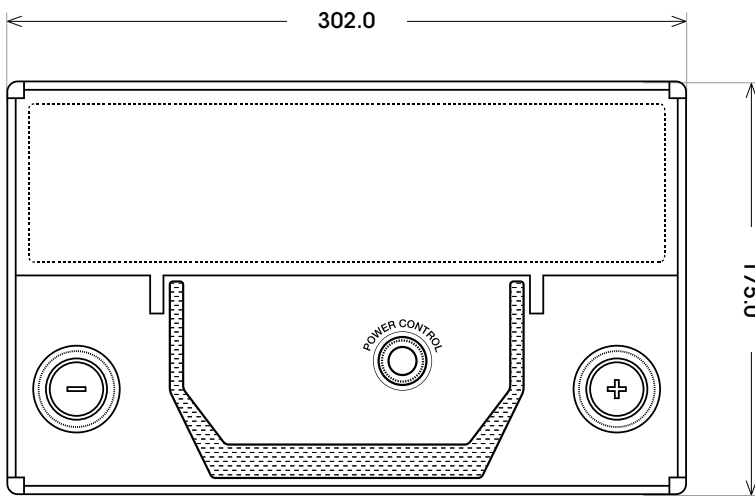
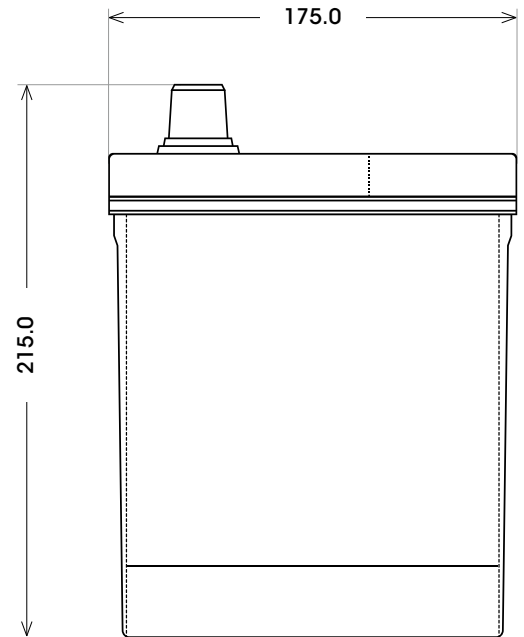
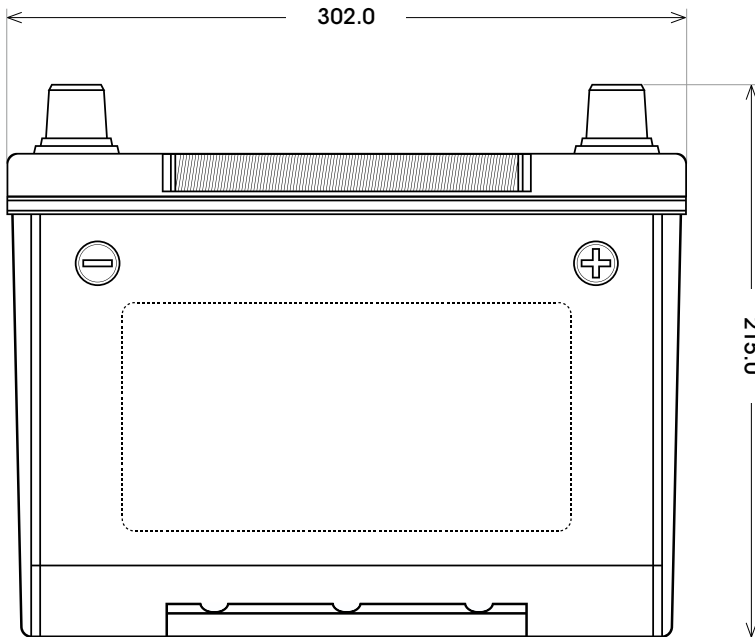

Technologie	Silber-Calcium
Spannung	12 V
Kapazität	100 Ah
Kälteprüfstrom	730 A/EN
Länge	302 mm
Breite	175 mm
Höhe	215 mm
Bodenleiste	B01
Schaltung	0
Polart	1
Gewicht	25.0 kg

Bodenleiste **B01**

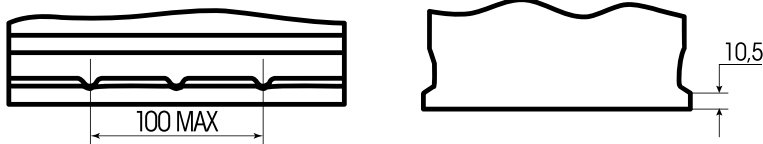

Schaltung **0**

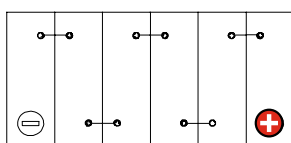

Anschlusspole **1**

