

Art. Nr.: **SB.5653033**

Bezeichnung: **56530**

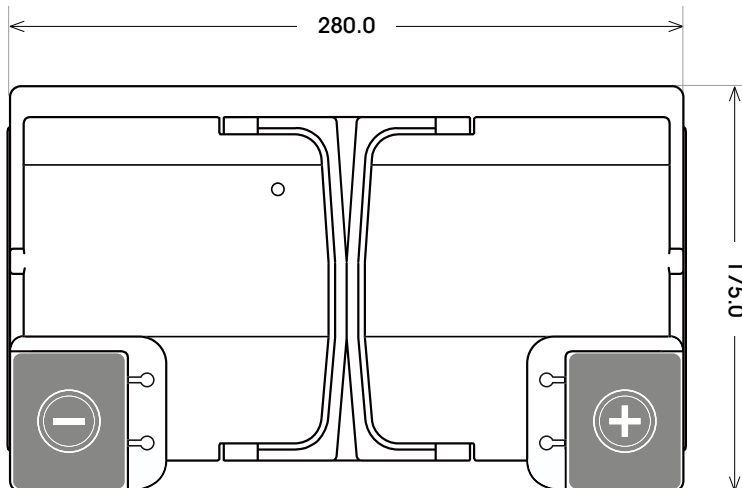
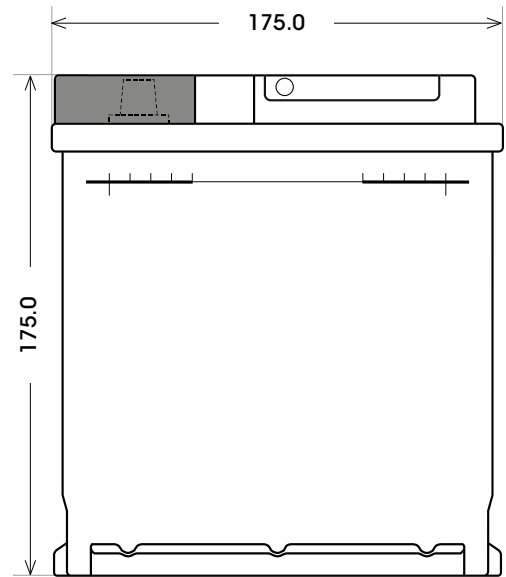
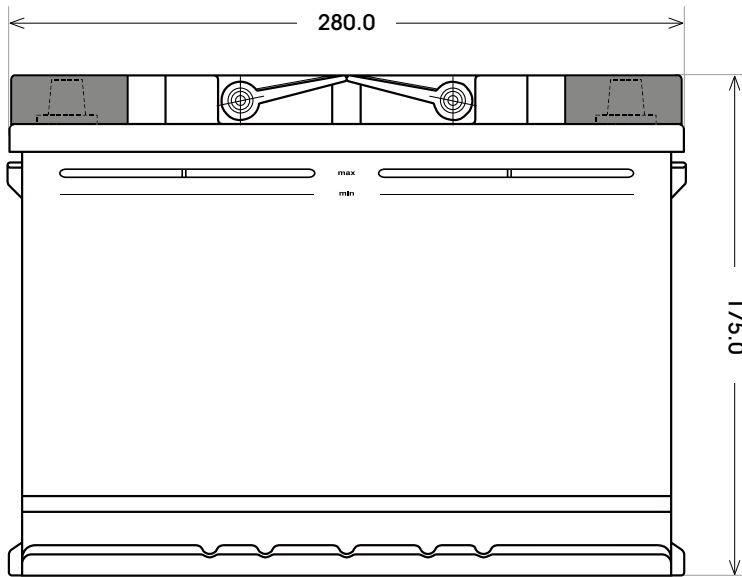

Technologie	Nassbatterie
Spannung	12 V
Kapazität	65 Ah
Kälteprüfstrom	540 A/EN
Länge	280 mm
Breite	175 mm
Höhe	175 mm
Bodenleiste	B13
Schaltung	0
Polart	1
Gewicht	15.9 kg

Bodenleiste **B13**

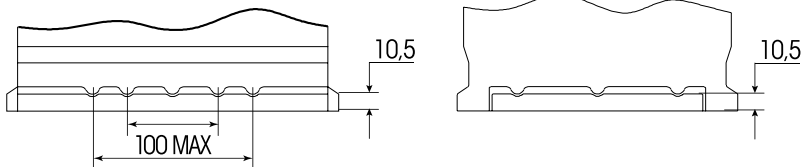

Schaltung **0**

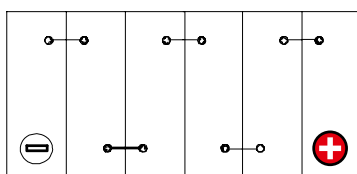

Anschlusspole **1**

