

Art. Nr.: **SB.6002633**

Bezeichnung: **60026**

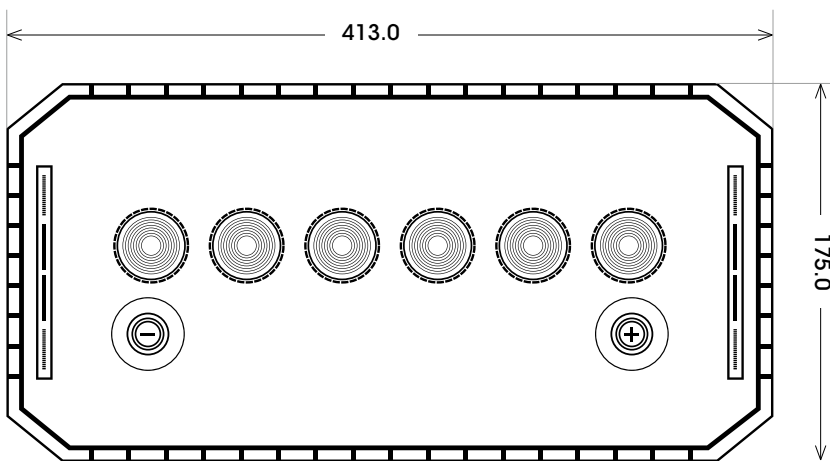
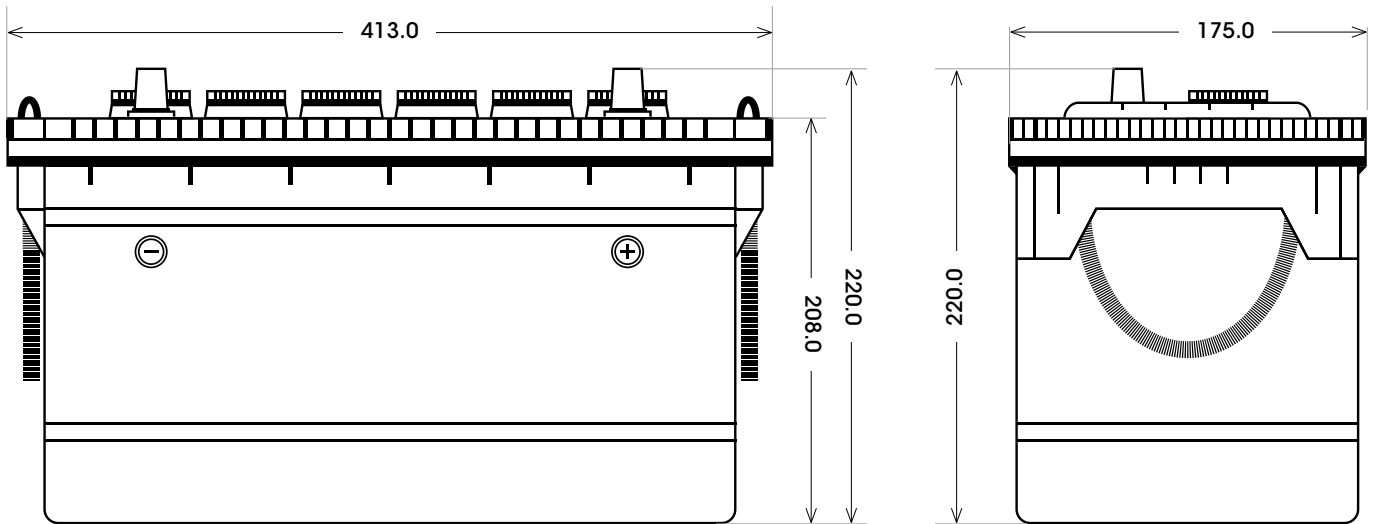

Technologie	Nassbatterie
Spannung	12 V
Kapazität	100 Ah
Kälteprüfstrom	600 A/EN
Länge	413 mm
Breite	175 mm
Höhe	220 mm
Bodenleiste	B00
Schaltung	0
Polart	1
Gewicht	26.7 kg

Bodenleiste **B00**

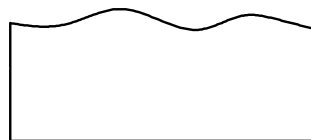

Schaltung **0**

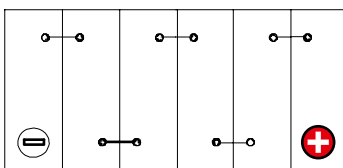

Anschlusspole **1**

