

Art. Nr.: **SB.ASIA02**

Bezeichnung: **ASIA 02**

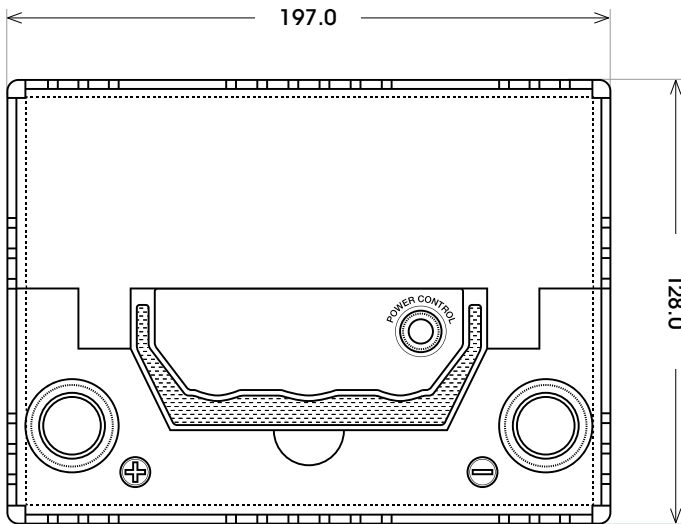
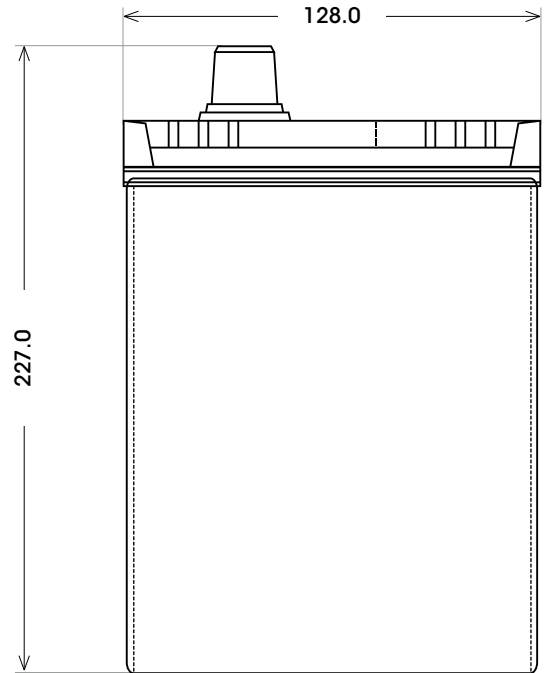
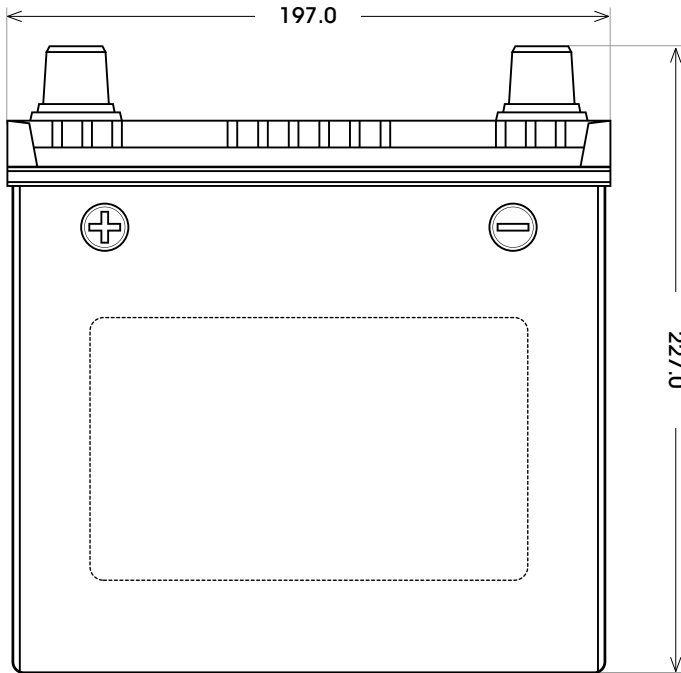

Technologie	Silber-Calcium
Spannung	12 V
Kapazität	40 Ah
Kälteprüfstrom	350 A/EN
Länge	197 mm
Breite	128 mm
Höhe	227 mm
Bodenleiste	B00
Schaltung	1
Polart	3
Gewicht	10.0 kg

Bodenleiste **B00**



Schaltung **1**

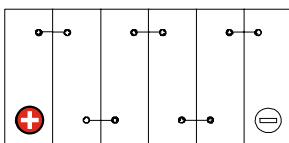

Anschlusspole **3**

