

Art. Nr.: **SB.5702433**

Bezeichnung: **57024**

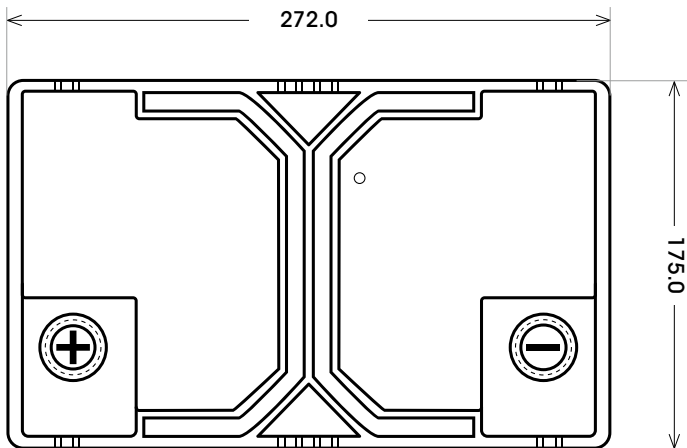
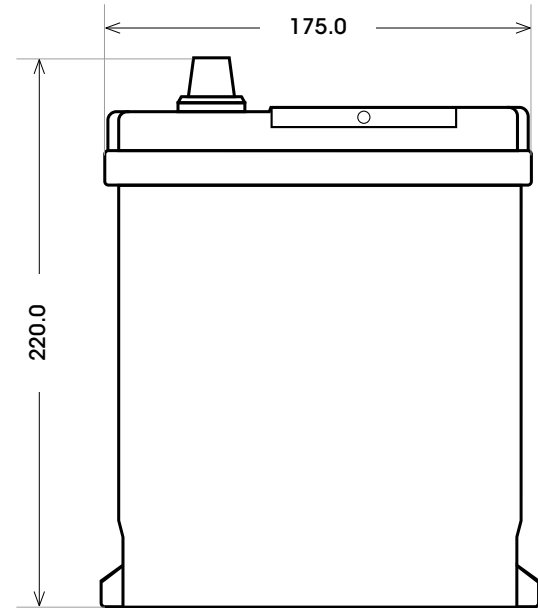
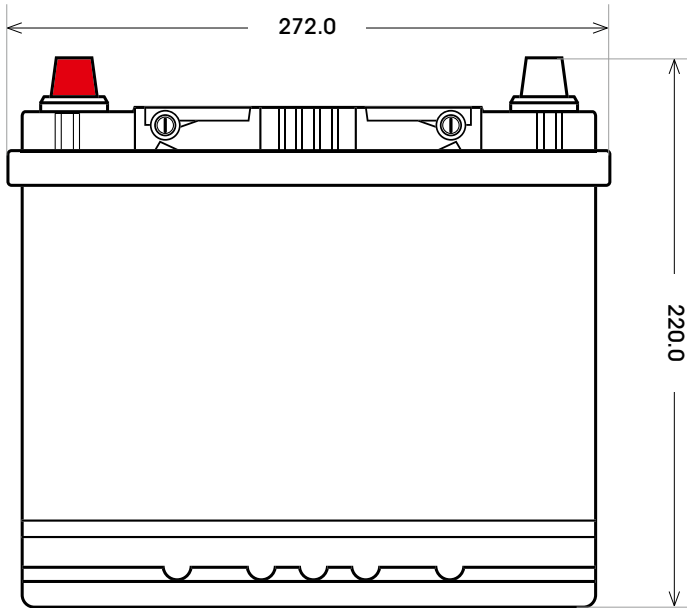

|                |              |
|----------------|--------------|
| Technologie    | Nassbatterie |
| Spannung       | 12 V         |
| Kapazität      | 70 Ah        |
| Kälteprüfstrom | 540 A/EN     |
| Länge          | 272 mm       |
| Breite         | 175 mm       |
| Höhe           | 220 mm       |
| Bodenleiste    | B01          |
| Schaltung      | 1            |
| Polart         | 1            |
| Gewicht        | 17.0 kg      |

Bodenleiste **B01**

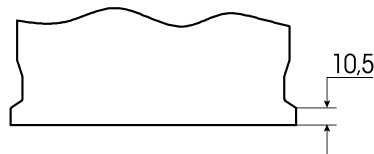
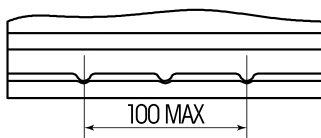

Schaltung **1**

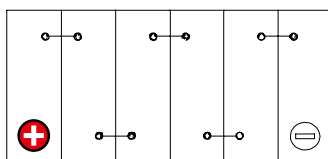

Anschlusspole **1**

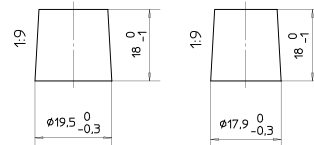

pos

neg

