

Art. Nr.: **SB.ASIA03**

Bezeichnung: **ASIA 03**

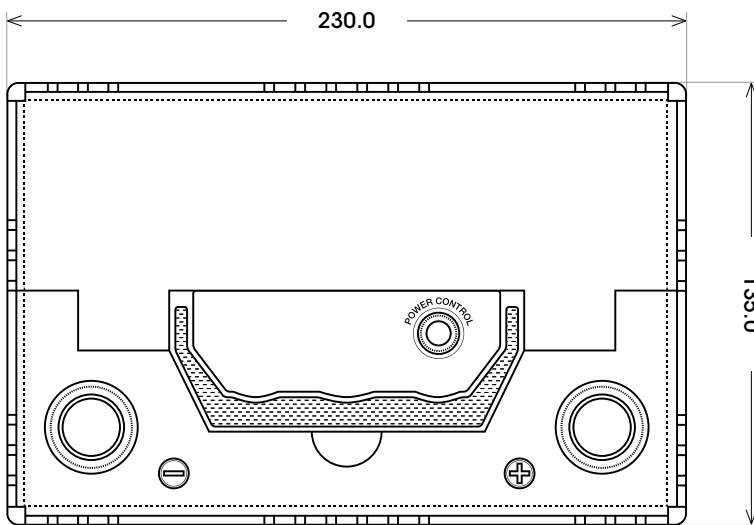
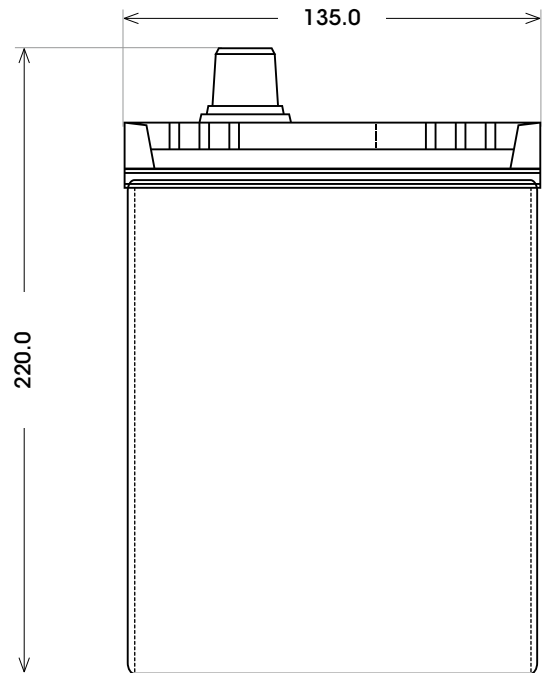
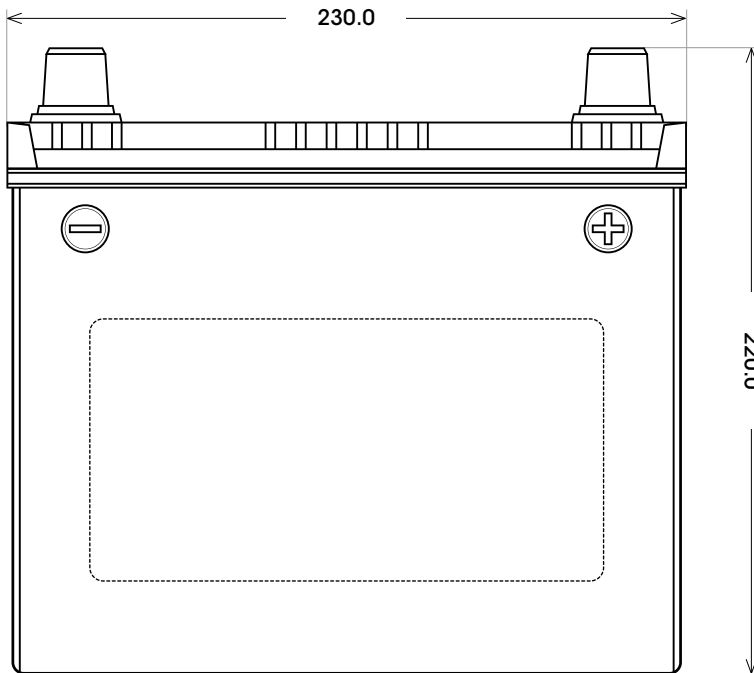

Technologie	Silber-Calcium
Spannung	12 V
Kapazität	50 Ah
Kälteprüfstrom	400 A/EN
Länge	230 mm
Breite	135 mm
Höhe	220 mm
Bodenleiste	B00
Schaltung	0
Polart	3
Gewicht	11.5 kg

Bodenleiste **B00**



Schaltung **0**

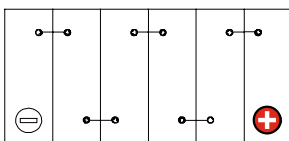

Anschlusspole **3**

