

Art. Nr.: **SB.6801933**

Bezeichnung: **68019**

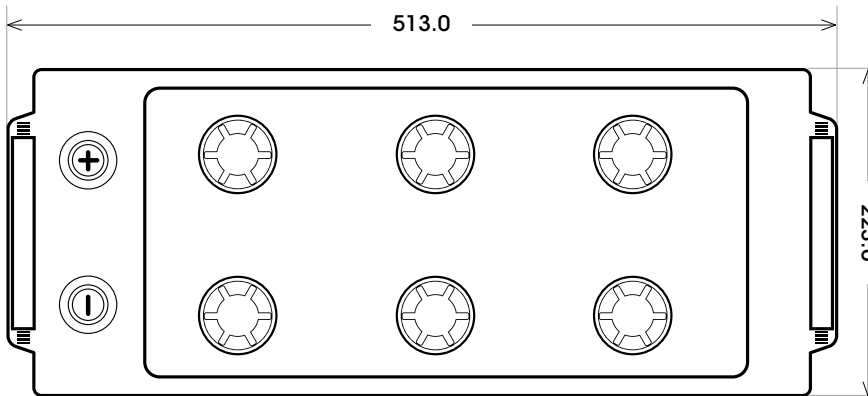
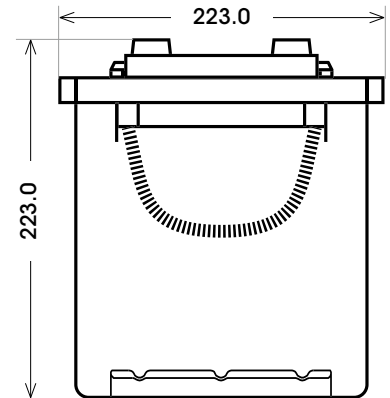
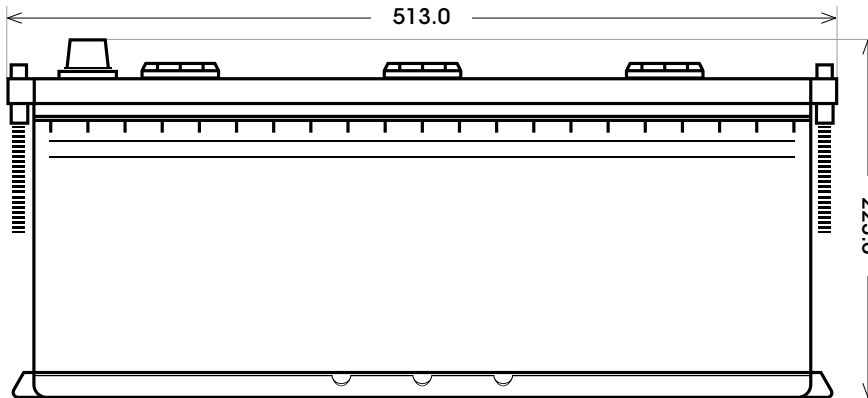

Technologie	Nassbatterie
Spannung	12 V
Kapazität	180 Ah
Kälteprüfstrom	1000 A/EN
Länge	513 mm
Breite	223 mm
Höhe	223 mm
Bodenleiste	B03
Schaltung	3
Polart	1
Gewicht	40.0 kg

Bodenleiste B03

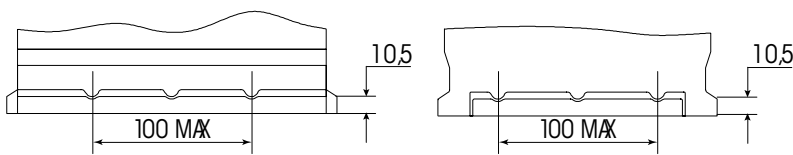

Schaltung 3

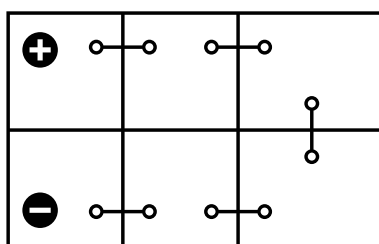

Anschlusspole 1

