

Art. Nr.:

PantherAGM80

Kurzbezeichnung:

AGM80

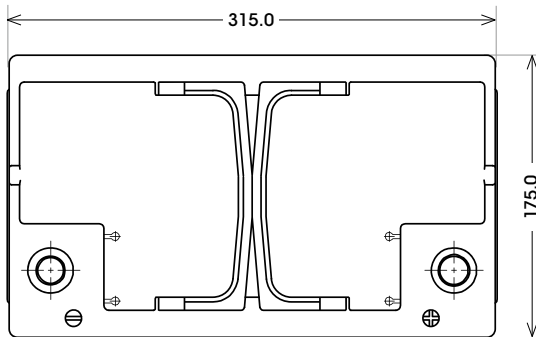
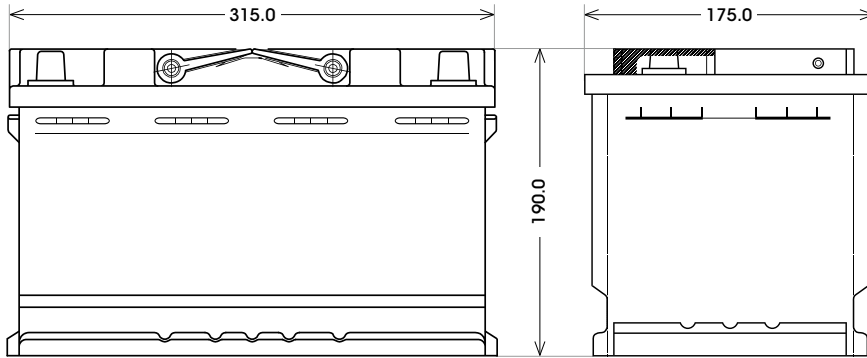

Technologie	AGM-VRLA
Spannung	12 V
Kapazität	80 Ah
Stunden H/C	100
Länge	315 mm
Breite	175 mm
Höhe	190 mm
Bodenleiste	B13
Schaltung	0
Polart	1
Gewicht	22.8 kg

Entladekurven

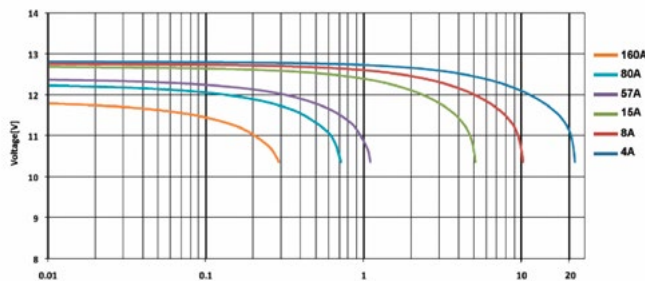

Entladezeit (Std.)
Einzelergebnisse können variieren

Bodenleiste B13

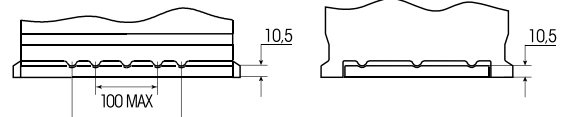

Schaltung 0

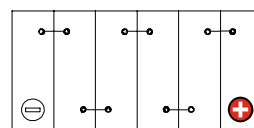

Anschlusspole 1

