

Art. Nr.: **SB.6808933**

Bezeichnung: **68089**

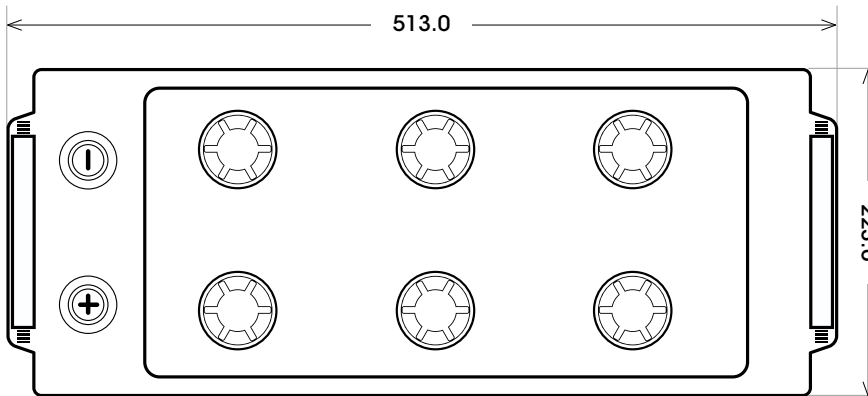
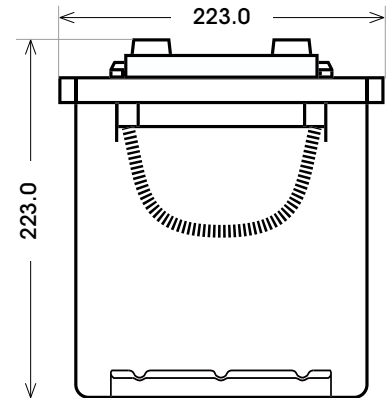
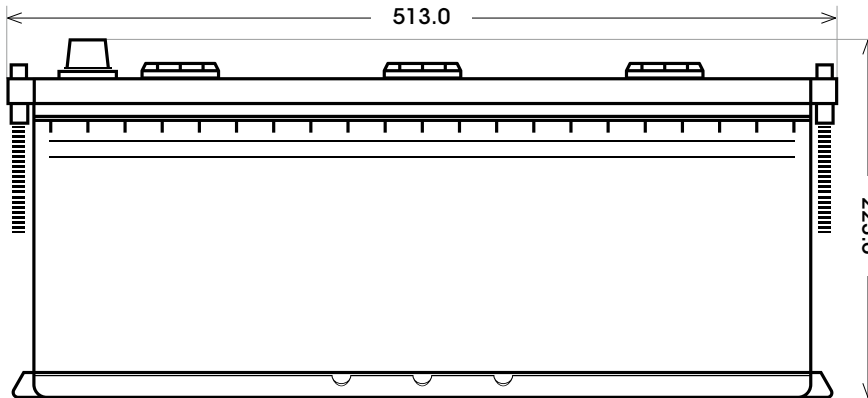

Technologie	Nassbatterie
Spannung	12 V
Kapazität	180 Ah
Kälteprüfstrom	1100 A/EN
Länge	513 mm
Breite	223 mm
Höhe	223 mm
Bodenleiste	B03
Schaltung	4
Polart	1
Gewicht	45.0 kg

Bodenleiste B03

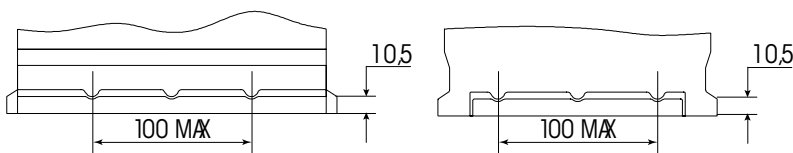

Schaltung 4

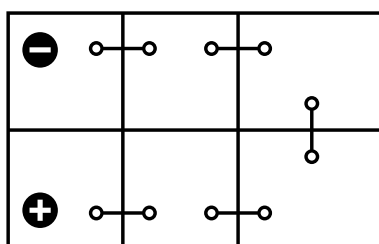

Anschlusspole 1

