

Art. Nr.: **SB.5459933**

Bezeichnung: **54599**

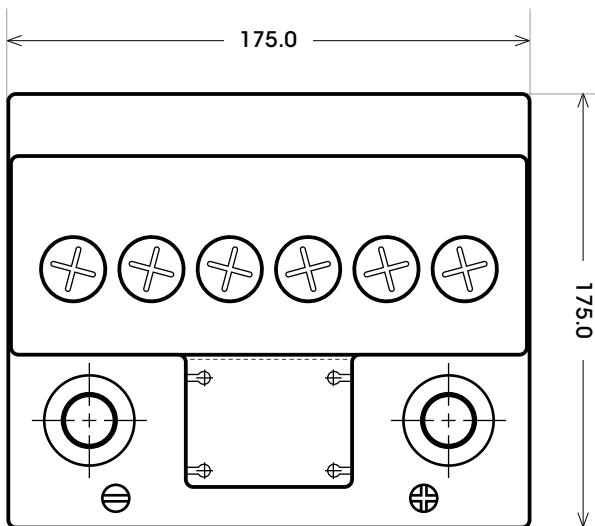
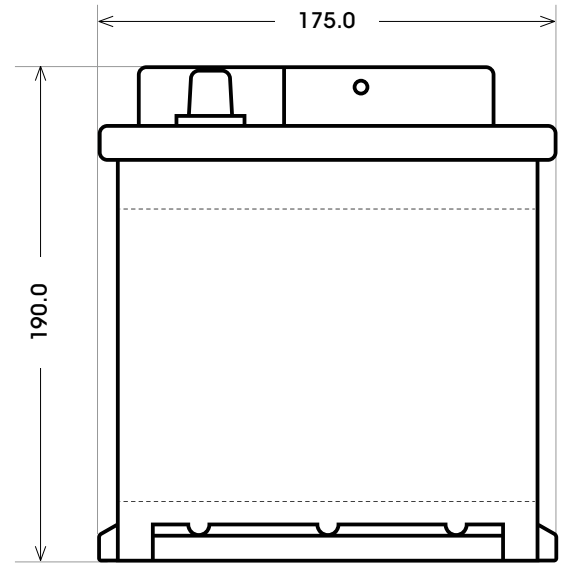
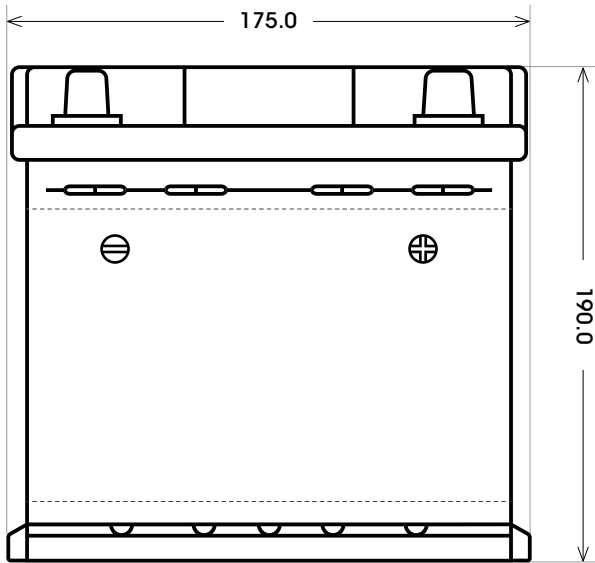

Technologie	Nassbatterie
Spannung	12 V
Kapazität	45 Ah
Kälteprüfstrom	390 A/EN
Länge	175 mm
Breite	175 mm
Höhe	190 mm
Bodenleiste	B13
Schaltung	0
Polart	1
Gewicht	10.2 kg

Bodenleiste **B13**

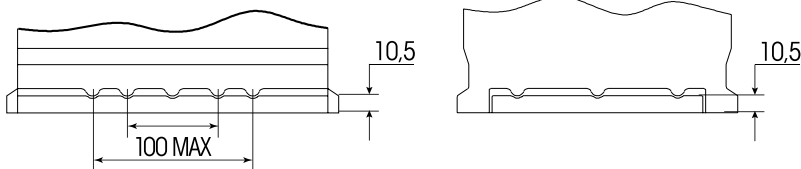

Schaltung **0**

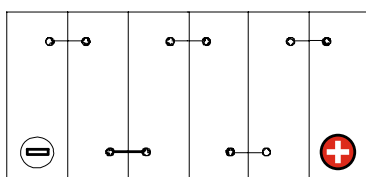

Anschlusspole **1**

