

Maßtoleranz: ± 2 mm

Art. Nr.: **SB.1351100**

Bezeichnung: **1351100**

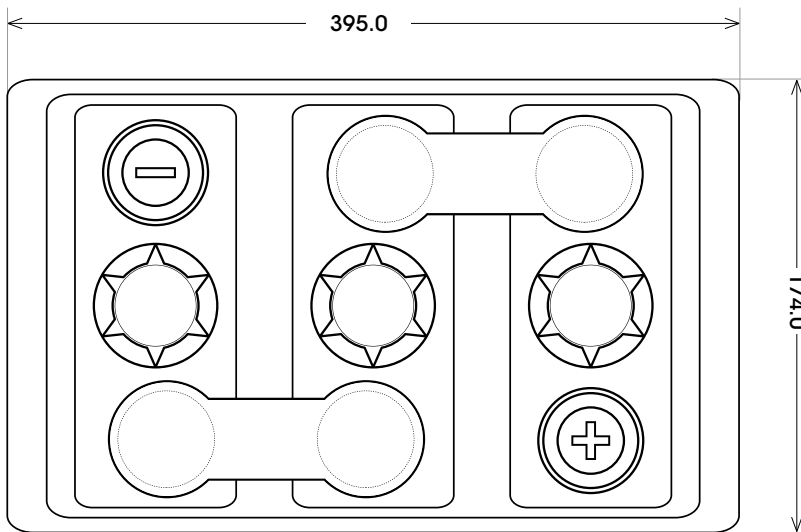
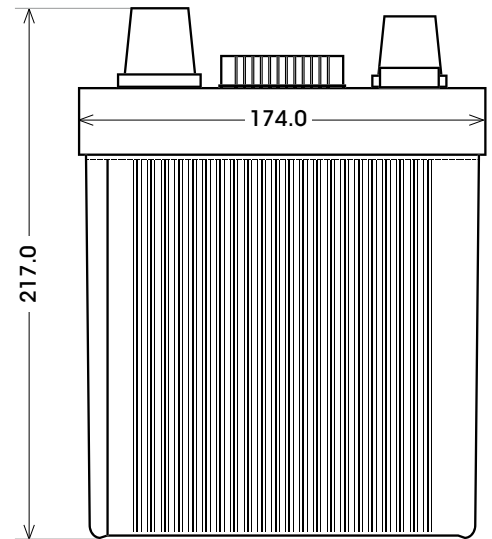
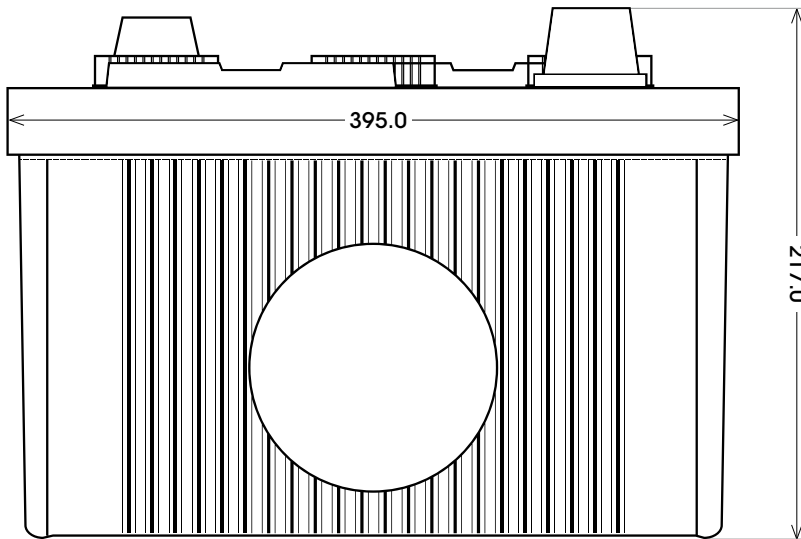

Technologie	Blei-Kalzium (Pb/Ca)
Spannung	6 V
Kapazität	135 Ah
Kälteprüfstrom	600 A/EN
Länge	395 mm
Breite	174 mm
Höhe	217 mm
Bodenleiste	B00
Schaltung	0
Polart	1
Gewicht	14.7 kg
Ausführung	trocken vorgeladen

Bodenleiste **B00**



Schaltung **0**

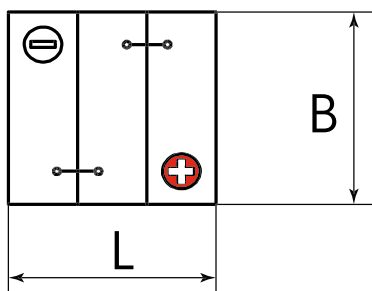

Anschlusspole **1**

