

Art. Nr.: **SB.5452333**

Bezeichnung: **54523**

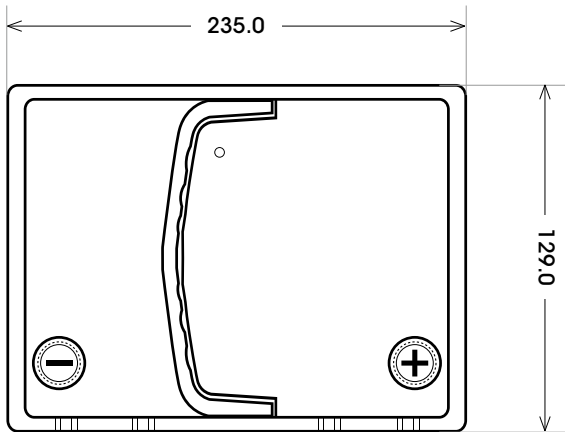
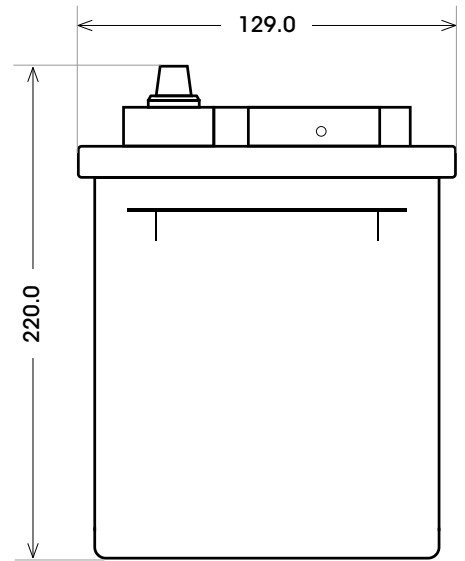
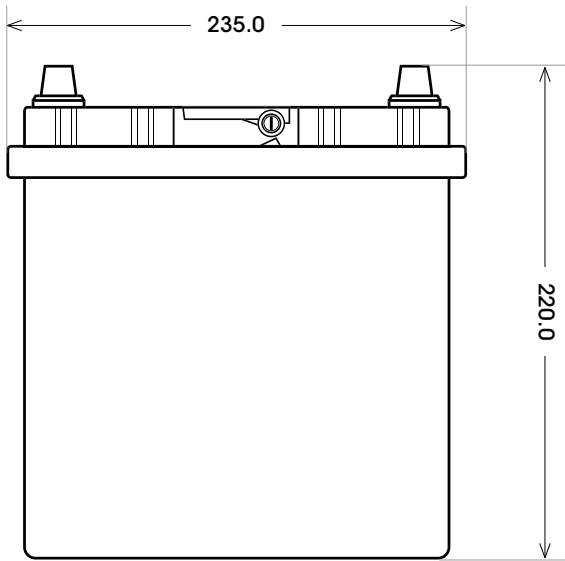

Technologie	Nassbatterie
Spannung	12 V
Kapazität	45 Ah
Kälteprüfstrom	300 A/EN
Länge	235 mm
Breite	129 mm
Höhe	220 mm
Bodenleiste	B00
Schaltung	0
Polart	1
Gewicht	11.7 kg

Bodenleiste **B00**



Schaltung **0**

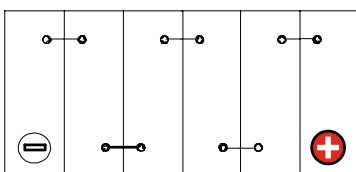

Anschlusspole **1**

