

Maßtoleranz: ± 2 mm

Art. Nr.: **SB.0771500**

Bezeichnung: **0771500**

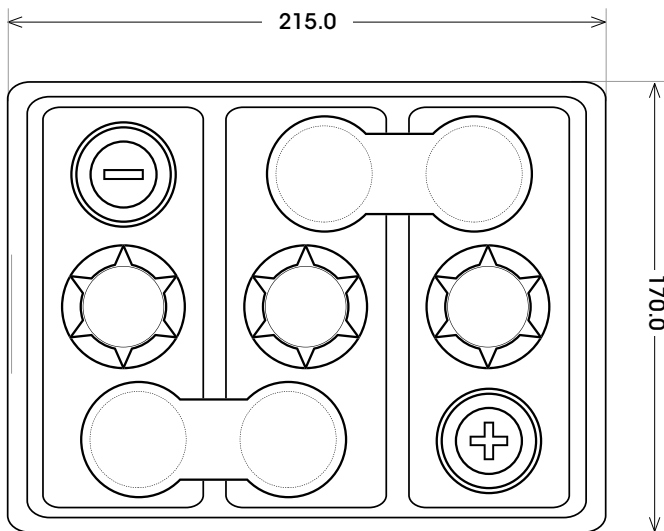
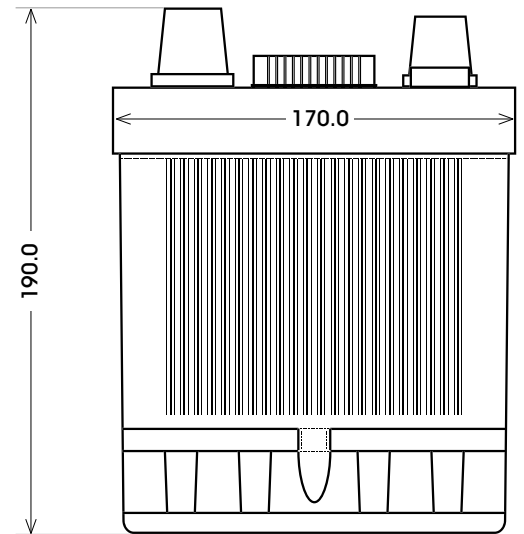
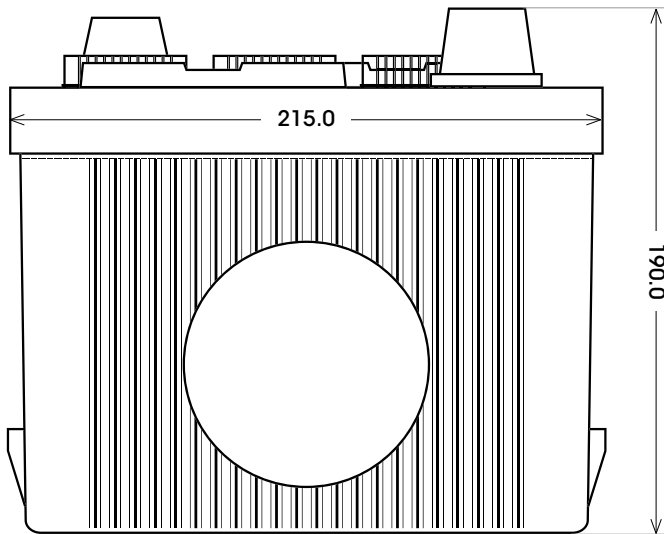

Technologie	Blei-Kalzium (Pb/Ca)
Spannung	6 V
Kapazität	77 Ah
Kälteprüfstrom	360 A/EN
Länge	215 mm
Breite	170 mm
Höhe	190 mm
Bodenleiste	B06
Schaltung	0
Polart	1
Gewicht	10.3 kg
Ausführung	trocken vorgeladen

Bodenleiste **B06**

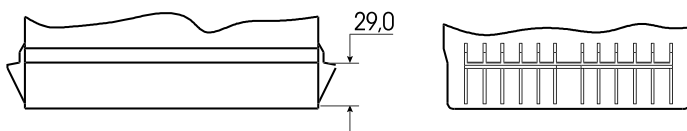

Schaltung **0**

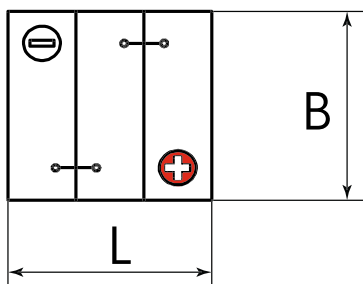

Anschlusspole **1**

