

Art. Nr.: **SB.5804233**

Bezeichnung: **58042**

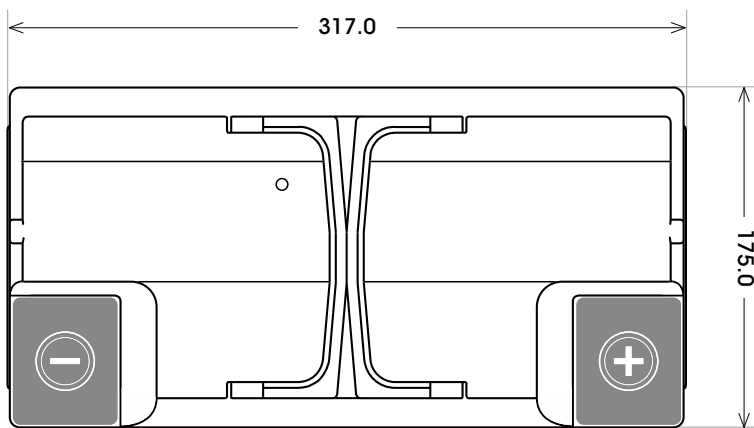
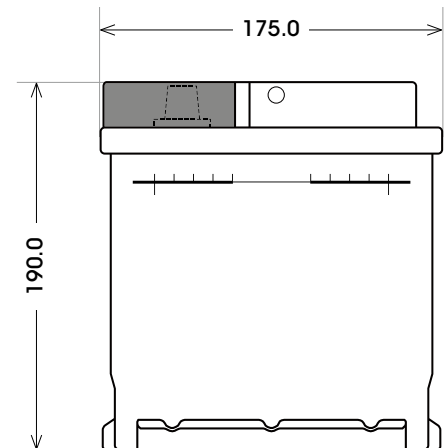
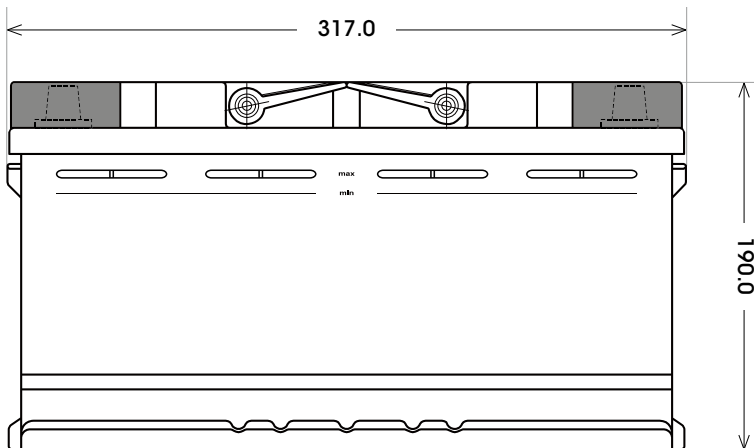

Technologie	Nassbatterie
Spannung	12 V
Kapazität	80 Ah
Kälteprüfstrom	640 A/EN
Länge	317 mm
Breite	175 mm
Höhe	190 mm
Bodenleiste	B13
Schaltung	0
Polart	1
Gewicht	19.1 kg

**Bodenleiste B13**

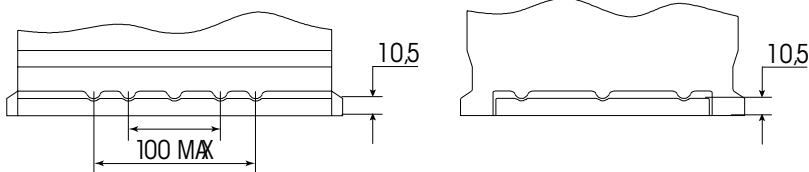

**Schaltung 0**

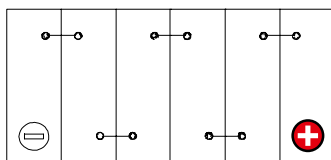

**Anschlusspole 1**

