



GRIP-TITE MANUFACTURING CO., LLC
115 W. JEFFERSON STREET
WINTERSET, IOWA 50273
TEL (515) 462-1313
FAX (515) 462-3465
www.griptite.com

GRIP-TITE® PUSH PIER SYSTEM

CSI Section:

31 66 13 Special Piles

1.0 RECOGNITION

Grip-Tite® Push Pier System recognized in this report has been evaluated for use to support foundations of existing structures or to provide additional bearing capacity to existing foundation systems. The structural performance of the Grip-Tite® Push Pier System complies with the intent of the provisions of the following codes and regulations:

- 2015, 2012 and 2009 International Building Code® (IBC)

2.0 LIMITATIONS

Use of the Grip-Tite® Push Pier System recognized in this report shall be subject to the following limitations:

2.1 The Grip-Tite® Push Pier System shall be installed by installers trained and certified by Grip-Tite. The Push Pier System shall be analyzed, designed, detailed, and installed in accordance with Section 1810 of the IBC, this report, the approved construction documents, and the manufacturer’s published installation instructions. In case of conflicts, the more restrictive shall govern.

2.2 Engineering analysis prepared by a registered design professional in accordance with recognized engineering principles as described in IBC Section 1604.4, shall be provided upon request to the building code official for approval.

2.3 Special inspection shall be provided in accordance with Section 3.4 of this report.

2.4 Settlement of push piers is beyond the scope of this evaluation report and shall be determined by a registered design professional as required in IBC Section 1810.2.3.

2.5 A geotechnical investigation report in accordance with IBC Section 1803.6 shall be provided upon request to the code official for approval as required by IBC Section 1803.5.5 for each project site.

2.6 The Push Pier System has not been evaluated for use in

soil conditions that are indicative of potential pier deterioration or corrosion that could occur in soils of low resistivity or high pH, those with high organic content or high sulfate concentrations, and those containing landfill or mining waste. Corrosion and galvanic action protection, and galvanic isolation shall be considered where applicable.

2.7 The push piers shall be used only to support structures that are laterally braced as defined in Section 1810.2.2 of the IBC.

2.8 The push piers shall be used only to support axial compression loads.

2.9 The push pier shafts shall be installed at a maximum angle of 5 degrees from vertical.

2.10 The effects of lateral and seismic loading have not been evaluated and are not in the scope of recognition of this report. Seismic design shall be considered in the engineering analysis where appropriate.

2.11 The Grip-Tite® Push Pier System components are produced in Winterset, Iowa.

3.0 PRODUCT USE

3.1 General: The Grip-Tite® Push Pier System is used to strengthen foundations of existing structures by providing an additional load path to reach deeper bearing strata or to provide additional support capacity to existing foundation systems. The system may be used to stabilize foundations or to provide additional support where existing foundations are inadequate.

3.2 Design: Structural calculations and drawings based on accepted engineering principles as described in IBC Section 1604.4, and conforming to IBC Section 1810, shall be prepared by a registered design professional and approved by the code official for each project. Structural analysis shall consider the loads required to be supported by the push piers and the capacity of the structure to withstand push pier installation and reactions, all applicable internal forces due to applied loads, structural eccentricity and maximum spans between push piers.

Grip-Tite Push Pier System shall be limited to an allowable axial compressive load of 21,709 lbf (96.5 kN) in service. Load sharing may be considered where the existing foundations and footings can be relied upon to support a portion of the building on stable soils. The spacing of the push piers shall not exceed 6 feet (1830 mm).

3.2.1 FP3BA Bracket Capacity: The FP3BA underpinning bracket allowable capacity in compression is 21,709 lbs (96.5 kN). Other structural requirements in IBC

The product described in this Uniform Evaluation Service (UES) Report has been evaluated as an alternative material, design or method of construction in order to satisfy and comply with the intent of the provision of the code, as noted in this report, and for at least equivalence to that prescribed in the code in quality, strength, effectiveness, fire resistance, durability and safety, as applicable, in accordance with IBC Section 104.11. This document shall only be reproduced in its entirety.





Chapter 19 and ACI 318 applicable to concrete foundations, such as those limit states described in ACI 318 (anchorage per Appendix D in ACI 318-11 and ACI 318-08 and Chapter 17 in ACI 318-14, punching (two-way) shear, beam (one-way) shear, and flexural (bending) related limit states), have not been evaluated. The capacity of the concrete foundation shall be justified to the satisfaction of the code official with due consideration to structural detailing, applicable limit states, and the direction and eccentricity of applied loads, including reactions provided by the brackets, acting on the concrete foundation.

3.2.2 Shaft Capacity: The tops of shafts shall be braced as prescribed in Section 1810.2.2 of the IBC. In accordance with Section 1810.2.1 of the IBC, any soil other than fluid soil shall be deemed to afford sufficient lateral support to prevent buckling of systems that are braced. When piers are standing in air, water or fluid soils, the unbraced length is defined as the length of piers that is standing in air, water or fluid soils plus an additional 5 feet (1524 mm) when embedded into firm soil or an additional 10 feet (3048 mm) when embedded into soft soil. Firm soils shall be defined as any soil with a Standard Penetration Test (SPT) blow count of five or greater. Soft soil shall be defined as any soil with a SPT blow count greater than zero and less than five. Fluid soils shall be defined as any soil with a SPT blow count of zero [weight of hammer (WOH) or weight of rods (WOR)]. The SPT blow counts shall be determined in accordance with ASTM D1586. For fully braced conditions where the pier is installed in accordance with Section 1810.2.2 of the IBC, and piers do not stand in air, water, or fluid soils, the design shaft capacities shall not exceed the ASD shaft allowable compression capacity of 30,759 lbf (137 kN) for steel pipes with corrosion protection. Shaft capacities of push pier foundation systems in air, water or fluid soils, shall be determined by a registered design professional.

The elastic shortening/lengthening of the pier shafts shall be controlled by the variation of applied loads from the pier lock-off load and the mechanical and geometrical properties of the nominal 3-inch-diameter (76 mm) hot-rolled steel tubes. The shaft elastic shortening may be determined from equation Eq.-1:

$$\Delta_{\text{shaft}} = \frac{\Delta P \times L}{A \times E} \quad (\text{Eq. 1})$$

Where:

- Δ_{shaft} = change in shaft length due to elastic shortening (inches/mm)
- ΔP = change in load between the applied load and the pier lock-off load (lbf/N)
- L = pier shaft length (inches/mm)
- A = shaft cross-sectional area (in²/mm²) (see Section 4.1.1)
- E = shaft steel modulus of elasticity (29,000,000 psi/199,900 MPa)

3.2.3 Soil Capacity: The allowable soil bearing capacity shall be determined by a registered design professional based on the soil type and final drive force (test load) applied during pier installation. The final drive force shall not exceed the maximum allowable capacity of the shaft or bracket used in installing the push pier.

3.2.4 System Capacity: The ASD allowable capacity of the Grip-Tite Push Pier System in compression shall be the lowest of the following three capacities: brackets, shafts, and soils.

3.3 Installation: The foundation footing shall be exposed to provide access to the location where the push pier will be installed. The steel bracket assembly shall bear fully and shall be bolted to the existing foundation footing. The support location may be shaped and prepared as required under the supervision of a qualified design professional to provide a safe and stable lifting point beneath the foundation wall.

The Grip-Tite Push Piers shall be installed using a calibrated hydraulic ram with known pressure-to-axial-force ratio. The equipment nominal loading capacity shall be minimum 120% of the test load applied. The steel tubes shall be pushed through the bracket using the hydraulic ram and support frame to transfer the reaction into the existing structure. As the pier tubes penetrate into the soil, additional push tube sections shall be added to allow deeper penetration until a suitable bearing stratum is reached. The hydraulic pressure shall be monitored throughout the process and recorded at 2-foot (610 mm) intervals or less. Installation shall continue until the pressure dial indicates that the piers have reached ultimate test load.

The test load shall be held for 30 minutes, or as specified by the registered design professional, with no deflection to confirm the pier capacity. After the push pier capacity is confirmed, the pier shall be permanently locked-off by securing the pier cap with threaded rod and nuts to the top tube to provide permanent support.

3.4 Special Inspection: Continuous special inspection in accordance with Section 1704.8 of the 2009 IBC or Section 1705.7 of the 2012 and 2015 IBC shall be provided where required for the installation of foundation piers and foundation brackets. Items to be confirmed by the special inspector include, but are not limited to, the manufacturer's certification of installers, verification of the product manufacturer, calibration certification for the installation equipment, push pier bracket and component configuration and identification, inclination and position of the push piers, final drive force, push pier lock-off load, depth of the foundation piers, and compliance of the installation with the approved construction documents and this evaluation report.

In lieu of continuous special inspection, periodic special inspection as defined in IBC Section 202 is permitted,



provided that all following requirements identified below, are satisfied: (1) The installers are certified by the manufacturer and the evidence of installer training and certification by the report holder are provided to the code official; (2) Structural observations in accordance with the 2009 IBC Section 1710, 2012 IBC Section 1704.5, or 2015 IBC Section 1704.6 are provided; (3) A periodic inspection schedule, as part of the statement of special inspection, prepared by a registered design professional, is submitted to and approved by the code official. As a minimum, the periodic inspection schedule shall include, but not be limited to, the following:

1. Before the start of work: verify the manufacturer, verify the installer's certification by the manufacturer, and confirm the push pier and bracket configuration compliance with the approved construction documents and this evaluation report.
2. Installation of the first push pier foundation system: verify that the location, inclination, final drive force, push pier lock-off load and depth of the push piers comply with the approved construction documents and this evaluation report. Verify that installers keep an installation log.
3. First connection to the building structure: verify that installation of the brackets complies with the approved construction documents and this evaluation report.
4. End of work: verify that the installation log complies with the requirements specified in the approved construction documents. Verify that installation of all structural connections complies with approved construction documents and this evaluation report.

4.0 PRODUCT DESCRIPTION

The Grip-Tite® Push Pier System consists of sectional steel tubes (lead tubes and extensions), couplers, and brackets. The system is an alternative to driven piles described in IBC Section 1810.3.1.4. The push pier system is intended to support only axial compression loads.

4.1 Material information

4.1.1 Push tubes: The push tubes, or shafts, are made from nominally 3-inch O.D. by 0.165-inch-thick (76 mm x 4.19 mm) high-strength ERW Structural Steel Tubing conforming to ASTM A500 Grade 1010 with a minimum tensile strength of 62,000 psi (428 MPa) and a minimum yield strength of 46,000 psi (317 MPa). The tubes are minimum 36 inches (914 mm) long and have a nominal cross-sectional area of 1.47 sq.in. (948 mm²). A coupler is inserted 1½ inches (38.1 mm) into the leading end and welded to the tip of each tube. The coupler is 2⅝-inch O.D., 0.188-inch-thick, 4 inches long (67 mm x 4.78 mm x 102

mm) and made of high-strength DOM Structural Steel Tubing conforming to ASTM A513, Type 5, Grade 1026 with a minimum tensile strength of 75,000 psi (517 MPa) and a minimum yield strength of 65,000 psi (448 MPa).

4.1.1.1 Friction Collar: A friction collar is connected to the tip on the outside of the lead tube (first tube pushed into the soil in every push pier assembly). The friction collar is 3.25-inch O.D., 0.220-inch-thick, 3⅛ inches long (83 mm x 5.59 mm x 79 mm) and made of high-strength ERW Structural Steel Tubing conforming to ASTM A513, Type 1, Grade 1010 steel with a minimum tensile strength of 45,000 psi (310 MPa) and a minimum yield strength of 32,000 psi (221 MPa). The friction collar is welded in accordance with AWS D1.1 using ER70 welding rod and minimum ⅜-inch (9.53 mm) fillet weld all around.

4.1.2 FP3BA Bracket: The bracket assembly consists of a bracket tube, an angle bracket, a top plate, a cap plate, a bracket support strap, and two threaded rods with nuts. The bracket tube is 3.875-inch O.D., 3.125-inch I.D., 0.375-inch wall, 12 inches long (98 mm x 79 mm x 9.53 mm x 305 mm) and made of ASTM A513, Type 5, Grade 1026 steel with a minimum tensile strength of 80,000 psi (552 MPa) and a minimum yield strength of 70,000 psi (483 MPa). The 90-degree angle bracket is ½-inch-thick (12.7 mm) steel plate, 10 inches wide (254 mm), with 8-inch (203 mm) legs in each direction. The tube is welded to the angle bracket at 5 degrees maximum from vertical. The bracket support strap consists of ⅜-inch-thick by 2-inch-wide steel bar, 21¼ inches long (9.53 mm x 51 mm x 540 mm), bent into a horseshoe shape around the bracket tube. The top plate is ¾-inch thick, 5½ inches wide, and 9½ inches long (19.1 mm x 140 mm x 241 mm). The cap plate is 1 inch thick, 4 inches wide, and 8½ inches long (25.4 mm x 102 mm x 216 mm). The angle bracket, top plate, cap plate, and bracket support strap are made of ASTM A36 steel with a minimum tensile strength of 58,000 psi (400 MPa) and a minimum yield strength of 36,000 psi (248 MPa). The bracket components are assembled and welded in accordance with the manufacturer's quality control documentation.

4.1.2.1 Threaded rod and nuts: The threaded rods are ¾-inch (19.1 mm) nominal diameter by 12 inches long (305 mm), ASTM A311, Class B, Grade 7 zinc plated steel with a minimum tensile strength of 125,000 psi (862 MPa) and a minimum yield strength of 105,000 psi (724 MPa), with ¾-inch (19.1 mm) hex head nuts. The threaded rods and nuts provide a height adjustment mechanism for the pier.

5.0 IDENTIFICATION

The Grip-Tite Push Pier System components described in this report are identified by labels that include the report holder's name (Grip-Tite Manufacturing Co., LLC), the product catalog number and description, the name and address of Co-Line Welding, Inc., and the IAPMO UES evaluation report number (ER-531). The identification



includes the IAPMO Uniform Evaluation Service Mark of Conformity. Either Mark of Conformity may be used as follows:

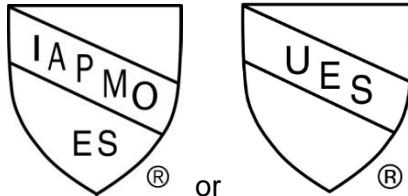

IAPMO UES ER-531

6.0 SUBSTANTIATING DATA

6.1 Reports of axial compressive load testing of the Grip-Tite Push Pier System in accordance with Section 4.3.2 of the ICC-ES Acceptance Criteria for Belled Segmented Pipe Foundation Systems and Devices, AC406, approved June 2011.

6.2 Material certificates for the tubes and steel plates used to fabricate the push piers and brackets.

6.3 Fabrication details of the push tubes and bracket assemblies.

6.4 Reports of testing in accordance with the ICC-ES Acceptance Criteria for Helical Pile Systems and Devices, AC358, approved September 2017, providing allowable loading for the bracket assembly and push tubes.

6.5 The Grip-Tite Manufacturing quality control manual and push pier installation instructions.

7.0 STATEMENT OF RECOGNITION

This evaluation report describes the results of research carried out by IAPMO Uniform Evaluation Service on the Grip-Tite Push Pier System labeled in Winterset, Iowa to assess its conformance to the codes listed in Section 1.0 of this report and serves as documentation of the product certification. The Push Pier System is produced at locations described in Section 2.11 of this report under a quality control program with periodic inspection under the supervision of IAPMO UES.

Brian Gerber, P.E., S.E.
Vice President, Technical Operations
Uniform Evaluation Service

Richard Beck, PE, CBO, MCP
Vice President, Uniform Evaluation Service

GP Russ Chaney
CEO, The IAPMO Group

For additional information about this evaluation report please visit www.uniform-es.org or email us at info@uniform-es.org



EVALUATION REPORT

Number:

531

Originally Issued: 07/07/2017

Revised: 07/31/2019

Valid Through: 07/31/2020

Pier Tube:
 FP3T
 Ø3.0" OD x 0.165" wall x 36"
 High Strength ERW Structural Steel Tubing
 per ASTM A500 Grade 1010
 Minimum Wall Thickness: 0.148"
 Min Yield Stress: $F_y=46\text{ksi}$
 Min Ult Tensile Stress: $F_u=62\text{ksi}$

Tube Coupler:
 FP4C
 Ø2.625" OD x .188 wall x 4"
 High Strength DOM Structural Steel Tubing per
 ASTM A513, Type 5, Grade 1026
 Min Yield Stress: $F_y=65\text{ksi}$
 Min Ult Tensile Stress: $F_u=75\text{ksi}$

Friction Collar:
 FP3FCH
 Ø3.25" OD x .220" wall x 3.125"
 High Strength ERW Structural Steel Tubing
 per ASTM A513, Type 1, Grade 1010
 Min Yield Stress: $F_y=32\text{ksi}$
 Min Ult Tensile Stress: $F_u=45\text{ksi}$

Outsert Tube:
 FP3TRO
 Ø3.5" OD x 0.188 wall x 36"
 High Strength ERW Structural Steel Tubing per
 ASTM A513, Type 1, Grade 1010
 Min Yield Stress: $F_y=32\text{ksi}$
 Min Ult Tensile Stress: $F_u=45\text{ksi}$

Outsert Ring:
 Ø4.0" x 0.25" wall x 0.5"
 High Strength ERW Structural Steel Tubing per
 ASTM A513, Type 1, Grade 1010
 Min Yield Stress: $F_y=32\text{ksi}$
 Min Ult Tensile Stress: $F_u=45\text{ksi}$

Weld:
 ER70 per AWS D1.1-2010
 Min Ult Tensile Stress: $F_u=70\text{ksi}$

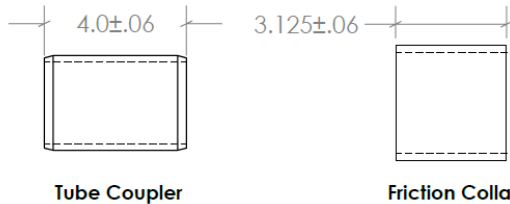
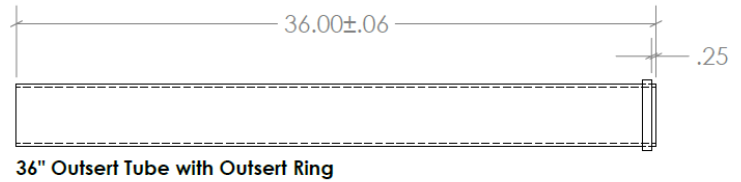
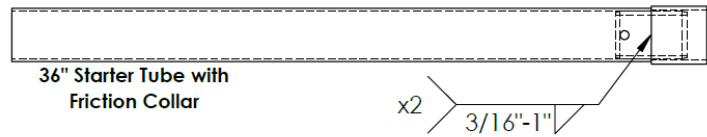
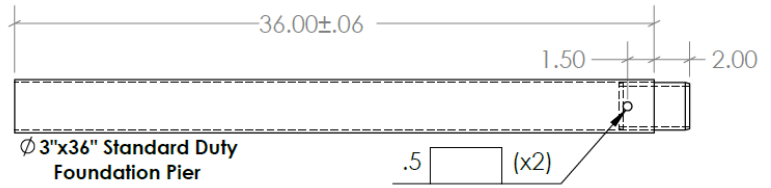

Optional Corrosion Protection:
 Hot-dipped Galvanized per ASTM A123-02
 Galvanization Thickness:
 Tube Material < 0.125" thick, Grade 45
 (0.0018")
 Tube material > 0.125" thick, Grade 75
 (0.0030")

Figure 1: The Grip-Tite Push Pier System tubes



EVALUATION REPORT

Number:

531

Originally Issued: 07/07/2017

Revised: 07/31/2019

Valid Through: 07/31/2020

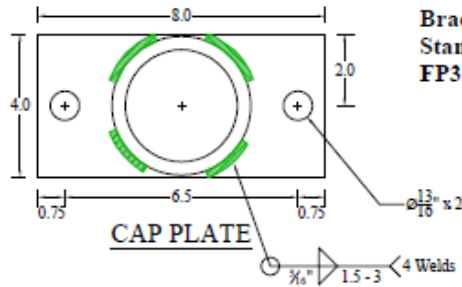

SIDE VIEW

Bracket Type
Standard Duty Bracket
FP3BA

CAP PLATE

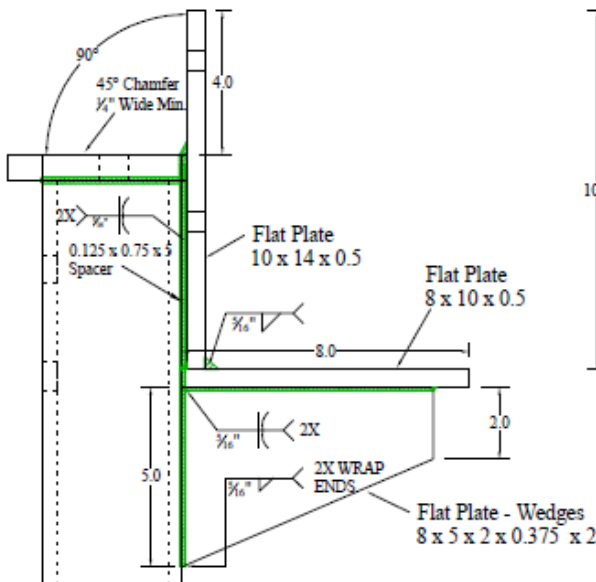
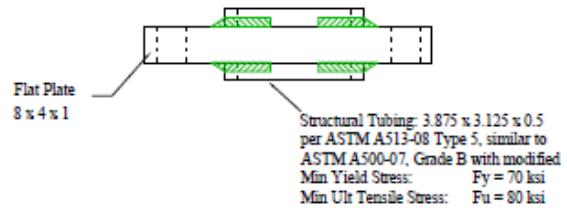

BRACKET TUBE: 3.875 x 3.125 x 0.375 x 12
ERW Structural Tubing per ASTM A513-08 Type 5,
similar to ASTM A500-07, Grade B with modified
Min Yield Stress: Fy = 70 ksi
Min Ult Tensile Stress: Fu = 80 ksi

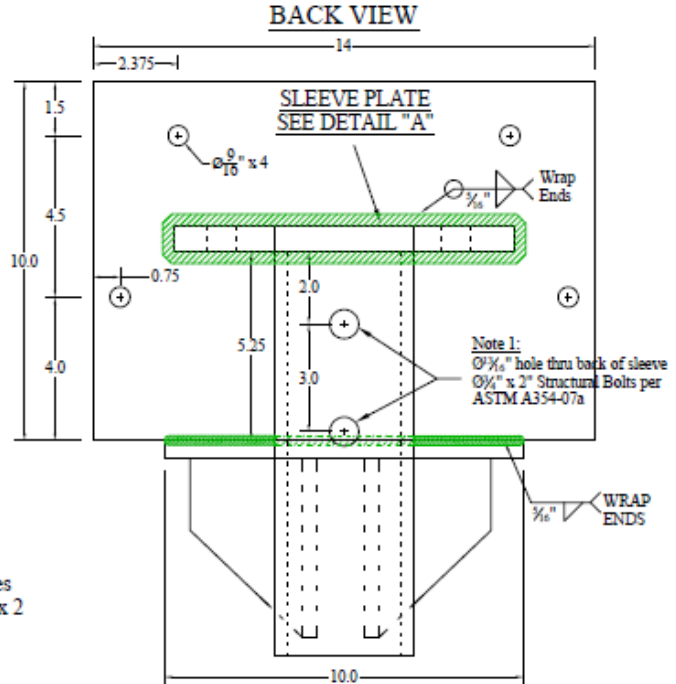

BACK VIEW

BOTTOM VIEW

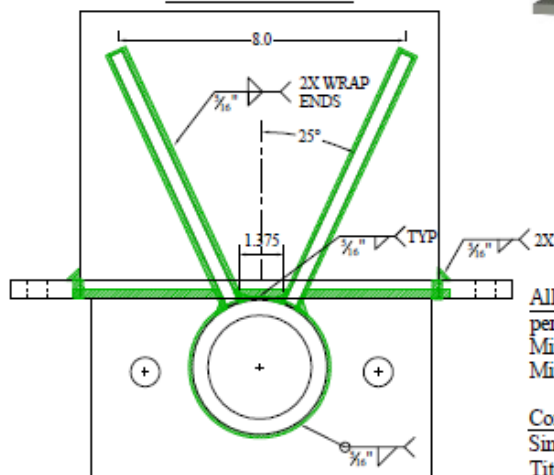

Weld: ER70 per AWS D1.1-2010
Min Tensile Stress: Fu = 70 ksi

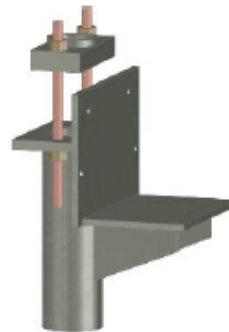

Note 1: Holes in Bracket Tube are for
Uplift or Tension Capacities, if
Necessary (FP3BA-U)

ALL-THREAD RODS AND NUTS:
1/2" x 12 per ASTM A193-08b
Grade 7 All-Thread Rods
Min Yield Stress, Fy = 105 ksi
Min Tensile Stress, Fu = 125ksi
with 4 Heavy Hex Nuts per
ASTM A194-09

Optional Corrosion Protection:
per ASTM A123-02 and ASTM A153-05

Flat Plate- Sleeve Plate
5 x 9.5 x 0.75

DETAIL "A"

All Flat Plate Steel:
per ASTM A36-08
Min Yield Stress, Fy = 36 ksi
Min Tensile Stress, Fu = 58 ksi

Concrete Anchors (not supplied):
Simpson Strong Tie®
Titen HD® Anchors installed per
ESR 2713-2010, 1/2" x 5 1/2"
minimum embedment of 5"

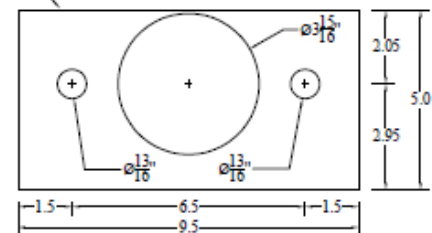



Figure 2: The Grip-Tite Push Pier System FP3BA Bracket

TABLE 1 – GRIP-TITE PUSH PIER (WITH UNDERPINNING BRACKET) ASD COMPRESSION CAPACITIES

Bracket Part No.	Shaft Part No. ¹	Bracket Description	Allowable Compression Capacity (kips) ⁶		
			Bracket ²	Shaft ³	Soil ⁵
FP3BA	FP3T	Underpinning Bracket	21.7	30.7 ⁴	TBD

For SI: 1 inch = 25.4 mm, 1 kip = 1,000 lbf = 4.448 kN

¹Shaft segments are 36 inches long.

²Bracket capacities are based on compression testing reacting against 2,700 psi concrete footings.

³Shaft capacities are applicable only to foundation systems that are fully braced.

⁴Represents shaft capacity using corrosion protection. The capacity is reduced to 24 kips for steel pipe without corrosion protection.

⁵Soil capacities shall be determined by a registered design professional. Maximum drive force shall not exceed 21.7 kips.

⁶Foundation system allowable capacities are based on the lowest of: the bracket, the shaft, and the soil capacities listed in this table.