

16 February 2016

---

## Agreement

### **Concerning the Adoption of Uniform Technical Prescriptions for Wheeled Vehicles, Equipment and Parts which can be Fitted and/or be Used on Wheeled Vehicles and the Conditions for Reciprocal Recognition of Approvals Granted on the Basis of these Prescriptions\***

(Revision 2, including the amendments which entered into force on 16 October 1995)

### **Addendum 116: Regulation No. 117**

#### **Revision 4**

Incorporating all valid text up to:

Corrigendum 4 to 02 series of amendments – Date of entry into force: 12 March 2014

Corrigendum 5 to 02 series of amendments (*Russian only*) – Date of entry into force: 12 March 2014

Supplement 5 to the 02 series of amendments – Date of entry into force: 10 June 2014

Supplement 6 to the 02 series of amendments – Date of entry into force: 9 October 2014

Supplement 7 to the 02 series of amendments – Date of entry into force: 8 October 2015

Supplement 8 to the 02 series of amendments – Date of entry into force: 20 January 2016

### **Uniform provisions concerning the approval of tyres with regard to rolling sound emissions and/or to adhesion on wet surfaces and/or to rolling resistance**

This document is meant purely as documentation tool. The authentic and legal binding texts of the supplements and the corrigenda are listed on the following page.



UNITED NATIONS

---

\* Former title of the Agreement:

Agreement Concerning the Adoption of Uniform Conditions of Approval and Reciprocal Recognition of Approval for Motor Vehicle Equipment and Parts, done at Geneva on 20 March 1958.

The authentic and legal binding texts of the supplements and the corrigenda are:

- ECE/TRANS/WP.29/2013/59
- ECE/TRANS/WP.29/2014/4
- ECE/TRANS/WP.29/2014/6
- ECE/TRANS/WP.29/2013/66 (as amended by paragraph 56 of the report ECE/TRANS/WP.29/1108)
- ECE/TRANS/WP.29/2015/5
- ECE/TRANS/WP.29/2015/65 (as amended by paragraph 66 of the report ECE/TRANS/WP.29/1116).

## Regulation No. 117

### Uniform provisions concerning the approval of tyres with regard to rolling sound emissions and/or to adhesion on wet surfaces and/or to rolling resistance

#### Contents

	<i>Page</i>
Regulation	
1. Scope .....	5
2. Definitions .....	5
3. Application for approval .....	9
4. Markings .....	11
5. Approval .....	11
6. Specifications .....	13
7. Modifications of the type of pneumatic tyre and extension of approval .....	18
8. Conformity of production .....	18
9. Penalties for non-conformity of production .....	19
10. Production definitively discontinued .....	19
11. Names and addresses of Technical Services responsible for conducting approval tests of Type Approval Authorities .....	20
12. Transitional provisions .....	20
Annexes	
1 Communication .....	22
2 Appendix 1 - Example of approval marks .....	24
Appendix 2 - Approval according to Regulation No. 117 coincident with approval of Regulation No. 30 or 54 .....	25
Appendix 3 - Extensions to combine approvals issued in accordance with Regulations Nos. 117, 30 or 54 .....	28
Appendix 4 - Extensions to combine approvals issued in accordance with Regulation No. 117 .....	29
3 Coast-by test method for measuring tyre-rolling sound emission .....	31
Appendix 1 - Test report .....	38
4 Specifications for the test site .....	40
5 Test procedures for measuring wet grip .....	47
Appendix - Test reports examples of wet grip index .....	73

6	Test procedure for measuring rolling resistance .....	75
	Appendix 1 - Test equipment tolerances .....	86
	Appendix 2 - Measuring rim width.....	89
	Appendix 3 - Test report and test data (Rolling resistance) .....	90
	Appendix 4 - Tyre standards organizations .....	91
	Appendix 5 - Deceleration method: Measurements and data processing for deceleration value obtaining in differential form $d\omega/dt$ .....	92
7	Procedures for snow performance testing relative to snow tyre for use in severe snow conditions ...	95
	Appendix 1 - Pictogram definition of "Alpine Symbol" .....	107
	Appendix 2 - Test reports and test data for C1 and C2 tyres .....	108
	Appendix 3 - Test reports and test data for C3 tyres.....	110

## 1. Scope

- 1.1. This Regulation applies to new pneumatic tyres of Classes C1, C2 and C3 with regard to their sound emissions, rolling resistance and to adhesion performance on wet surfaces (wet adhesion). It does not, however, apply to:
  - 1.1.1. Tyres designed as "Temporary use spare tyres" and marked "Temporary use only";
  - 1.1.2. Tyres having a nominal rim diameter code  $\leq 10$  (or  $\leq 254$  mm) or  $\geq 25$  (or  $\geq 635$  mm);
  - 1.1.3. Tyres designed for competitions;
  - 1.1.4. Tyres intended to be fitted to road vehicles of categories other than M, N and O;<sup>1</sup>
  - 1.1.5. Tyres fitted with additional devices to improve traction properties (e.g. studded tyres);
  - 1.1.6. Tyres with a speed rating less than 80 km/h (speed symbol F);
  - 1.1.7. Tyres designed only to be fitted to vehicles registered for the first time before 1 October 1990.
  - 1.1.8. Professional off-road tyres.
- 1.2. Contracting Parties shall issue or accept approvals to rolling sound and/or wet adhesion and/or rolling resistance.

## 2. Definitions

For the purpose of this Regulation, in addition to the definitions contained in Regulations Nos. 30 and 54, the following definitions apply.

- 2.1. "*Type of tyre*" means, in relation to this Regulation, a range of tyres consisting of a list of tyre size designations, brand names and trade descriptions, which do not differ in such essential characteristics as:
  - (a) The manufacturer's name;
  - (b) The tyre class (see paragraph 2.4. below);
  - (c) The tyre structure;
  - (d) The category of use: normal tyre, snow tyre and special use tyre;
  - (e) For Class C1 tyres:
    - (i) In case of tyres submitted for approval of rolling sound emission levels, whether normal or reinforced (or extra load);

---

<sup>1</sup> As defined in the Consolidated Resolution on the Construction of Vehicles (R.E.3), document ECE/TRANS/WP.29/78/Rev.4, para. 2. - [www.unece.org/trans/main/wp29/wp29wgs/wp29gen/wp29resolutions.html](http://www.unece.org/trans/main/wp29/wp29wgs/wp29gen/wp29resolutions.html)

- (ii) In case of tyres submitted for approval of performance adhesion on wet surfaces, whether normal tyres or snow tyres with a speed category of Q or below excluding H ( $\leq 160$  km/h) or speed category R and above including H ( $> 160$  km/h);
  - (f) For Classes C2 and C3 tyres:
    - (i) In case of tyres submitted for approval of rolling sound emission levels at stage 1, whether M+S marked or not;
    - (ii) In case of tyres submitted for approval of rolling sound emission levels at stage 2, whether traction tyre or not;
  - (g) The tread pattern (see paragraph 3.2.1. of this Regulation).
- 2.2. "*Brand name*" or "*Trade description*" means the identification of the tyre as given by the tyre manufacturer. The brand name may be the same as that of the manufacturer and the trade description may coincide with the trade mark.
- 2.3. "*Rolling sound emission*" means the sound emitted from the contact between the tyres in motion and the road surface.
- 2.4. "*Tyre class*" means one of the following groupings:
- 2.4.1. *Class C1 tyres*: Tyres conforming to Regulation No. 30;
- 2.4.2. *Class C2 tyres*: Tyres conforming to Regulation No. 54 and identified by a load capacity index in single formation lower or equal to 121 and a speed category symbol higher or equal to "N";
- 2.4.3. *Class C3 tyres*: Tyres conforming to Regulation No. 54 and identified by:
- (a) A load capacity index in single formation higher or equal to 122; or
  - (b) A load capacity index in single formation lower or equal to 121 and a speed category symbol lower or equal to "M".
- 2.5. "*Representative tyre size*" means the tyre size which is submitted to the test described in Annex 3 to this Regulation with regard to rolling sound emissions, or Annex 5 for adhesion on wet surfaces or Annex 6 for rolling resistance to assess the conformity for the type approval of the type of tyre, or Annex 7 for use in severe snow conditions.
- 2.6. "*Temporary-use spare tyre*" means a tyre different from a tyre intended to be fitted to any vehicle for normal driving conditions; but intended only for temporary use under restricted driving conditions.
- 2.7. "*Tyres designed for competition*" means tyres intended to be fitted to vehicles involved in motor sport competition and not intended for non-competitive on-road use.
- 2.8. "*Normal tyre*" means a tyre intended for normal on-road use.
- 2.9. "*Reinforced tyre*" or "*extra load tyre*" of Class C1 means a pneumatic-tyre structure designed to carry more load at a higher inflation pressure than the load carried by the corresponding standard version tyre at the standard inflation pressure as specified in ISO 4000-1:2010.<sup>2</sup>

---

<sup>2</sup> Class C1 tyres correspond to "passenger car tyres" in ISO 4000-1:2010.

- 2.10. "*Traction tyre*" means a tyre in Class C2 or C3 bearing the inscription TRACTION and intended to be fitted primarily to the drive axle(s) of a vehicle to maximize force transmission in various circumstances.
- 2.11. "*Snow tyre*" means a tyre whose tread pattern, tread compound or structure is primarily designed to achieve in snow conditions a performance better than that of a normal tyre with regard to its ability to initiate or maintain vehicle motion.
- 2.11.1. "*Snow tyre for use in severe snow conditions*" means a snow tyre whose tread pattern, tread compound or structure is specifically designed to be used in severe snow conditions and that fulfils the requirements of paragraph 6.4. of this Regulation.
- 2.12. "*Special use tyre*" means a tyre intended for mixed use both on- and off-road or for other special duty. These tyres are primarily designed to initiate and maintain the vehicle in motion in off-road conditions.
- 2.13. "*Professional off-road tyre*" is a special use tyre primarily used for service in severe off-road conditions.
- 2.14. "*Tread depth*" means the depth of the principal grooves.
- 2.14.1. "*Principal grooves*" means the wide circumferential grooves positioned in the central zone of the tyre tread, which, in the case of passenger and light truck (commercial) tyres, have the treadwear indicators located in the base.
- 2.15. "*Void to fill ratio*" means the ratio between the area of voids in a reference surface and the area of this reference surface calculated from the mould drawing.
- 2.16. "*Standard Reference Test Tyre (SRTT)*" means a tyre that is produced, controlled and stored in accordance with the American Society for Testing and Materials (ASTM) standards
- (a) E1136-93 (2003) for the size P195/75R14
  - (b) F2872 (2011) for the size 225/75 R 16 C
  - (c) F2871 (2011) for the size 245/70R19.5
  - (d) F2870 (2011) for the size 315/70R22.5.
- 2.17. Wet grip or snow grip measurements – Specific definitions
- 2.17.1. "*Adhesion on wet surfaces*" means the relative braking performance, on a wet surface, of a test vehicle equipped with the candidate tyre in comparison to that of the same test vehicle equipped with a reference tyre (SRTT).
- 2.17.2. "*Candidate tyre*" means a tyre, representative of the type that is submitted for approval in accordance with this Regulation.
- 2.17.3. "*Control tyre*" means a normal production tyre that is used to establish the wet grip or snow grip performance of tyre sizes unable to be fitted to the same vehicle as the standard reference test tyre – see paragraph 4.1.7. of Annex 5 and paragraph 3.4.3. of Annex 7 to this Regulation.
- 2.17.4. "*Wet grip index ("G")*" means the ratio between the performance of the candidate tyre and the performance of the standard reference test tyre.

- 2.17.5. "Snow grip index ("SG")" means the ratio between the performance of the candidate tyre and the performance of the standard reference test tyre.
- 2.17.6. "Peak brake force coefficient ("pbfc")" means the maximum value of the ratio of braking force to vertical load on the tyre prior to wheel lock-up.
- 2.17.7. "Mean fully developed deceleration ("mfdd")" means the average deceleration calculated on the basis of the measured distance recorded when decelerating a vehicle between two specified speeds.
- 2.17.8. "Coupling (hitch) height" means the height when measured perpendicularly from the centre of the articulation point of the trailer towing coupling or hitch to the ground, when the towing vehicle and trailer are coupled together. The vehicle and trailer shall be standing on level pavement surface in its test mode complete with the appropriate tyre(s) to be used in the particular test.
- 2.18. Rolling resistance measurement - Specific definitions
- 2.18.1. Rolling resistance  $F_r$   
Loss of energy (or energy consumed) per unit of distance traveled.<sup>3</sup>
- 2.18.2. Rolling resistance coefficient  $C_r$   
Ratio of the rolling resistance to the load on the tyre.<sup>4</sup>
- 2.18.3. New test tyre  
A tyre which has not been previously used in a rolling deflected test that raises its temperature above that generated in rolling resistance tests, and which has not previously been exposed to a temperature above 40 °C.<sup>5,6</sup>
- 2.18.4. Laboratory control tyre  
Tyre used by an individual laboratory to control machine behaviour as a function of time.<sup>7</sup>
- 2.18.5. Capped inflation  
Process of inflating the tyre and allowing the inflation pressure to build up, as the tyre is warmed up while running.
- 2.18.6. Parasitic loss  
Loss of energy (or energy consumed) per unit distance excluding internal tyre losses, attributable to aerodynamic loss of the different rotating elements of the test equipment, bearing friction and other sources of systematic loss which may be inherent in the measurement.

---

<sup>3</sup> The International System of Units (SI) unit conventionally used for the rolling resistance is the newton-meter per meter, which is equivalent to a drag force in newton.

<sup>4</sup> The rolling resistance is expressed in newton and the load is expressed in kilo-newton. The rolling resistance coefficient is dimensionless.

<sup>5</sup> New test tyre definition is needed to reduce potential data variation and dispersion due to tyre aging effects.

<sup>6</sup> It is permissible to repeat an accepted test procedure.

<sup>7</sup> An example of machine behaviour is drift.



- 2.18.7. Skim test reading  
Type of parasitic loss measurement, in which the tyre is kept rolling without slippage, while reducing the tyre load to a level at which energy loss within the tyre itself is virtually zero.
- 2.18.8. Inertia or moment of inertia.  
Ratio of the torque applied to a rotating body to the rotational acceleration of this body.<sup>8</sup>
- 2.18.9. Measurement reproducibility  $\sigma_m$   
Capability of a machine to measure rolling resistance.<sup>9</sup>

### 3. Application for approval

- 3.1. The application for approval of a type of tyre with regard to this Regulation shall be submitted by the tyre manufacturer or by his duly accredited representative. It shall specify:
- 3.1.1. The performance characteristics to be assessed for the tyre type; "rolling sound emissions level" and/or "adhesion performance level on wet surfaces" and/or "rolling resistance level". Tyre "snow performance level" in cases of "snow tyre for use in severe snow conditions";
- 3.1.2. Name of manufacturer;
- 3.1.3. Name and address of applicant;
- 3.1.4. Address(es) of manufacturing plant(s);
- 3.1.5. Brand name(s), trade description(s), trade mark(s);
- 3.1.6. Tyre class (Class C1, C2 or C3) (see paragraph 2.4. of this Regulation);
- 3.1.6.1. Section width range for Class C1 tyres (see paragraph 6.1.1. of this Regulation);
- Note:* This information is required only for approval with regard to rolling sound emission level.

<sup>8</sup> The rotating body can be, for example, a tyre assembly or machine drum.

<sup>9</sup> Measurement reproducibility  $\sigma_m$  shall be estimated by measuring  $n$  times (where  $n \geq 3$ ), on a single tyre, the whole procedure described in paragraph 4. of Annex 6 as follows:

$$\sigma_m = \sqrt{\frac{1}{n-1} \cdot \sum_{j=1}^n \left( Cr_j - \frac{1}{n} \cdot \sum_{j=1}^n Cr_j \right)^2}$$

Where:

$j$  = is the counter from 1 to  $n$  for the number of repetitions of each measurement for a given tyre,

$n$  = number of repetitions of tyre measurements ( $n \geq 3$ ).

- 3.1.7. Tyre structure;
- 3.1.8. For Class C1 tyres, state whether:
- (a) Reinforced (or extra load) in case of approval with regard to rolling sound emission level;
  - (b) Speed category symbol "Q" or below (excluding "H") or "R" and above (including "H") in case of "snow" tyres for approval with regard to adhesion on wet surfaces;
- For Classes C2 and C3 tyres, state whether:
- (a) M+S marked in case of approval with regard to rolling sound emission level at stage 1;
  - (b) Traction in case of approval with regard to rolling sound emission level at stage 2.
- 3.1.9. Category of use (normal, snow, or special);
- 3.1.10. A list of tyre size designations covered by this application.
- 3.2. The application for approval shall be accompanied (in triplicate) by:
- 3.2.1. Details of the major features, with respect to the effects on the performance (i.e. rolling sound emission level, adhesion on wet surfaces, rolling resistance and snow grip) of the tyres, including the tread pattern, included in the designated range of tyre sizes. This may be by means of descriptions supplemented by technical data, drawings, photographs and Computer Tomography (CT), and must be sufficient to allow the Type Approval Authority or Technical Service to determine whether any subsequent changes to the major features will adversely affect the tyre performance. The effects of changes to minor details of tyre construction on tyre performances will be evident and determined during checks on conformity of production;
- 3.2.2. Drawings or photographs of the tyre sidewall, showing the information given in paragraph 3.1.8. above and the approval marking referred to in paragraph 4., shall be submitted once the production has been established, but no later than one year after the date of granting of type approval.
- 3.2.3. In the case of applications relating to special use tyres, a copy of the mould drawing of the tread pattern shall be supplied in order to allow verification of the void-to-fill ratio.
- 3.3. At the request of the Type Approval Authority, the applicant shall submit samples of tyres for test or copies of test reports from the Technical Services, communicated as given in paragraph 11. of this Regulation.
- 3.4. With regard to the application, testing may be confined to a worst case selection, at the discretion of the Type Approval Authority or designated Technical Service.
- 3.5. The laboratories and test facilities of a tyre manufacturer may be designated as an approved laboratory and the Type Approval Authority shall have the option of being represented during any tests.

## **4. Markings**

- 4.1. All tyres constituting the type of tyre shall be marked as prescribed by either Regulation No. 30 or 54, as applicable.
- 4.2. In particular tyres shall bear:<sup>10</sup>
  - 4.2.1. The manufacturer's name or trade mark;
  - 4.2.2. The trade description (see paragraph 2.2. of this Regulation). However, the trade description is not required when it coincides with the trade mark;
  - 4.2.3. The tyre size designation;
  - 4.2.4. The inscription "REINFORCED" (or alternatively "EXTRA LOAD") if the tyre is classified as reinforced;
  - 4.2.5. The inscription "TRACTION"<sup>11</sup> if the tyre is classified as "traction tyre";
  - 4.2.6. The "Alpine" symbol ("3-peak-mountain with snowflake" conforming to the symbol described in Annex 7, Appendix 1) shall be added if the snow tyre is classified as "snow tyre for use in severe snow conditions".
  - 4.2.7. The inscription "MPT" (or alternatively "ML" or "ET") and /or "POR" if the tyre is classified in the category of use "special".  
  
ET means Extra Tread, ML stands for Mining and Logging, MPT means Multi-Purpose Truck and POR means Professional Off-Road.
- 4.3. Tyres shall provide adequate space for the approval mark as shown in Annex 2 to this Regulation.
- 4.4. The approval mark shall be moulded into or onto the sidewall of the tyre, shall be clearly legible and shall be located in the lower area of the tyre on at least one of the sidewalls.
  - 4.4.1. However, in the case of tyres identified by the tyre to rim fitment configuration symbol "A", the marking may be located anywhere on the outside sidewall of the tyre.

## **5. Approval**

- 5.1. If the representative tyre size of the type of tyre submitted for approval pursuant to this Regulation meets the requirements of paragraphs 6. and 7. below, approval of that type of tyre shall be granted.
- 5.2. An approval number shall be assigned to the type of tyre approved. The same Contracting Party may not assign the same number to another type of tyre.
- 5.3. Notice of approval or extension of approval or refusal of approval of a type of tyre pursuant to this Regulation shall be communicated to the Parties to the Agreement, which apply this Regulation by means of a form conforming to the model in Annex 1 to the Regulation.

---

<sup>10</sup> Some of these requirements may be specified separately in Regulation No. 30 or 54.

<sup>11</sup> Minimum height of marking: refer to dimension C in Annex 3 of Regulation No. 54.

- 5.3.1. Tyre manufacturers are entitled to submit an application for extension of type approval to the requirements of other Regulations relevant to the tyre type. In that case, a copy of the relevant type approval communication(s), as issued by the relevant Type Approval Authority, shall be attached to the application for extension of approval. All applications for extension of approval(s) shall only be granted by the Type Approval Authority which issued the original approval for the tyre.
- 5.3.1.1. When extension of approval is granted to incorporate into the communication form (see Annex 1 to this Regulation) certification(s) of conformity to other Regulations, the approval number on the communication form shall be supplemented by suffix(es) to identify the given Regulation(s) and the technical prescriptions which have been incorporated by the extension of approval. In relation to each given suffix, the specific type approval number(s) and the Regulation itself shall be added to item 9. of Annex 1 - Communication form.
- 5.3.1.2. The prefix shall identify the series of amendments of the prescription on tyre performances for the relevant Regulation, e.g. 02S2 to identify the second series of amendments on tyre road rolling sound emissions at stage 2 or 02S1WR1 to identify the second series of amendments on tyre road rolling sound emissions at stage 1, tyre adhesion on wet surfaces and rolling resistance at stage 1 (see paragraph 6.1. below for stage 1 and stage 2 definitions). No identification to the series of amendments shall be required if the relevant Regulation is in its original form.
- 5.3.2. The following suffixes have been already reserved to identify specific Regulations on tyre performance parameters:
- S To identify additional conformity to the requirements on tyre rolling sound emissions;
  - W To identify additional conformity to the requirements on tyre adhesion on wet surfaces;
  - R To identify additional conformity to the requirements on tyre rolling resistance.
- Taking into account that two stages are defined for rolling sound and rolling resistance specifications in paragraphs 6.1. and 6.3. below, S and R will be followed either by the suffix "1" for compliance to stage 1 or by the suffix "2" for compliance to stage 2.
- 5.4. In the space referred to in paragraph 4.3. and in accordance with the requirements of paragraph 4.4. above there shall be affixed to every tyre size, conforming to the type of tyre approved under this Regulation, an international approval mark consisting of:
- 5.4.1. A circle surrounding the letter "E" followed by the distinguishing number of the country which has granted approval;<sup>12</sup> and

---

<sup>12</sup> The distinguishing numbers of the Contracting Parties to the 1958 Agreement are reproduced in Annex 3 to the Consolidated Resolution on the Construction of Vehicles (R.E.3), document ECE/TRANS/WP.29/78/Rev. 4, Annex 3 - [www.unece.org/trans/main/wp29/wp29wgs/wp29gen/wp29resolutions.html](http://www.unece.org/trans/main/wp29/wp29wgs/wp29gen/wp29resolutions.html)

- 5.4.2. The approval number, which shall be placed close to the circle prescribed in paragraph 5.4.1. above either above or below the "E" or to the left or right of that letter.
- 5.4.3. The suffix(es), and the identification to the relevant series of amendments, if any, as specified in the communication form.

One of the suffixes listed below or any combination of them can be used.

S1	Sound level at stage 1
S2	Sound level at stage 2
W	Wet adhesion level
R1	Rolling resistance level at stage 1
R2	Rolling resistance level at stage 2

These suffixes shall be placed to the right or below the approval number, if part of the original approval.

If the approval is extended subsequent to Regulation No. 30 or 54 approvals, the addition sign "+" and the series of amendment to Regulation No. 117 shall be placed in front of the suffix or any combination of suffixes to denote an extension to the approval.

If the approval is extended subsequent to the original approval under Regulation No. 117, the addition sign "+" shall be placed between the suffix or any combination of suffixes of the original approval and the suffix or any combination of suffixes added to denote an extension to the approval.

- 5.4.4. The marking on the tyre sidewalls of suffix(es) to the approval number removes the requirement for any additional marking on the tyre of the specific type approval number for conformity to the Regulation(s) to which the suffix refers as per paragraph 5.3.2. above.
- 5.5. If the tyre conforms to type approvals under one or more other Regulations annexed to the Agreement in the country which has granted approval under this Regulation, the symbol prescribed in paragraph 5.4.1. above need not be repeated. In such a case the additional numbers and symbols of all the Regulations under which approval has been granted in the country which has granted approval under this Regulation shall be placed adjacent to the symbol prescribed in paragraph 5.4.1. above.
- 5.6. Annex 2 to this Regulation gives examples of arrangements of approval marks.

## **6. Specifications**

- 6.1. Rolling sound emission limits, as measured by the method described in Annex 3 to this Regulation.
- 6.1.1. For Class C1 tyres, the rolling sound emission value shall not exceed the values pertinent to the applicable stage given below. These values refer to the nominal section width as given in paragraph 2.17.1.1. of Regulation No. 30:

<i>Stage 1</i>	
<i>Nominal section width</i>	<i>Limit dB(A)</i>
145 and lower	72
Over 145 up to 165	73
Over 165 up to 185	74
Over 185 up to 215	75
Over 215	76

The above limits shall be increased by 1 dB(A) for extra load tyres or reinforced tyres and by 2 dB(A) for "special use tyres".

<i>Stage 2</i>	
<i>Nominal section width</i>	<i>Limit dB(A)</i>
185 and lower	70
Over 185 up to 245	71
Over 245 up to 275	72
Over 275	74

The above limits shall be increased by 1 dB(A) for "snow tyre for use in severe snow conditions", extra load tyres or reinforced tyres, or any combination of these classifications.

- 6.1.2. For Class C2 tyres, the rolling sound emission value with reference to its category of use (see paragraph 2.1., subparagraph (d) above) shall not exceed the values pertinent to the applicable stage given below:

<i>Stage 1</i>	
<i>Category of use</i>	<i>Limit dB(A)</i>
Normal tyre	75
Snow tyre	77
Special use tyre	78

<i>Stage 2</i>			
<i>Category of use</i>		<i>Limit dB(A)</i>	
		<i>Other</i>	<i>Traction tyres</i>
Normal tyre		72	73
Snow tyre		72	73
	Snow tyre for use in severe snow conditions	73	75
Special use tyre		74	75

- 6.1.3. For Class C3 tyres, the rolling sound emission value with reference to its category of use (see paragraph 2.1., subparagraph (d) above) shall not exceed the values pertinent to the applicable stage given below:

<i>Stage 1</i>	
<i>Category of use</i>	<i>Limit dB(A)</i>
Normal tyre	76
Snow tyre	78
Special use tyre	79

<i>Stage 2</i>			
<i>Category of use</i>		<i>Limit dB(A)</i>	
		<i>Other</i>	<i>Traction tyres</i>
Normal tyre		73	75
Snow tyre		73	75
	Snow tyre for use in severe snow conditions	74	76
Special use tyre		75	77

- 6.2. The wet grip performance will be based on a procedure that compares either peak brake force coefficient ("pbfc") or mean fully developed deceleration ("mfdd") against values achieved by a standard reference test tyre (SRTT). The relative performance shall be indicated by a wet grip index (G).
- 6.2.1. For Class C1 tyres, tested in accordance with either procedure given in Annex 5, Part (A), to this Regulation, the tyre shall meet the following requirements:

<i>Category of use</i>		<i>Wet grip index (G)</i>
Normal tyre		≥ 1.1
Snow tyre		≥ 1.1
	"Snow tyre for use in severe snow conditions" and with a speed symbol ("R" and above, including "H") indicating a maximum permissible speed greater than 160 km/h	≥ 1.0
	"Snow tyre for use in severe snow conditions" and with a speed symbol ("Q" or below excluding "H") indicating a maximum permissible speed not greater than 160 km/h	≥ 0.9
Special use tyre		Not defined

- 6.2.2. For Class C2 tyres, tested in accordance with either procedure given in Annex 5, Part (B), to this Regulation, the tyre shall meet the following requirements:

Category of use		Wet grip index (G)	
		Other	Traction tyres
Normal tyre		≥ 0.95	≥ 0.85
Snow tyre		≥ 0.95	≥ 0.85
	Snow tyre for use in severe snow conditions	≥ 0.85	≥ 0.85
Special use tyre		≥ 0.85	≥ 0.85

- 6.2.3. For Class C3 tyres, tested in accordance with either procedure given in Annex 5, Part (B), to this Regulation, the tyre shall meet the following requirements:

Category of use		Wet grip index (G)	
		Other	Traction tyres
Normal tyre		≥ 0.80	≥ 0.65
Snow tyre		≥ 0.65	≥ 0.65
	Snow tyre for use in severe snow conditions	≥ 0.65	≥ 0.65
Special use tyre		≥ 0.65	≥ 0.65

- 6.3. Rolling resistance coefficient limits, as measured by the method described in Annex 6 to this Regulation.

- 6.3.1. The maximum values for stage 1 for the rolling resistance coefficient shall not exceed the following (value in N/kN is equivalent to value in kg/tonne):

Tyre class	Max value (N/kN)
C1	12.0
C2	10.5
C3	8.0

For "snow tyre for use in severe snow conditions", the limits shall be increased by 1 N/kN.

- 6.3.2. The maximum values for stage 2 for the rolling resistance coefficient shall not exceed the following (value in N/kN is equivalent to value in kg/tonne):

Tyre class	Max value (N/kN)
C1	10.5
C2	9.0
C3	6.5

For "snow tyre for use in severe snow conditions", the limits shall be increased by 1 N/kN.



6.4. In order to be classified as a "snow tyre for use in severe snow conditions" the tyre shall meet the performance requirements of paragraph 6.4.1. below. The tyre shall meet these requirements based on a test method of Annex 7 by which:

- (a) The mean fully developed deceleration ("mfdd") in a braking test,
  - (b) Or alternatively an average traction force in a traction test,
  - (c) Or alternatively the average acceleration in an acceleration test
- of the candidate tyre is compared to that of a standard reference tyre.

The relative performance shall be indicated by a snow index.

6.4.1. Tyre snow performance requirements

6.4.1.1. Class C1, C2 and C3 tyres

The minimum snow index value, as calculated in the procedure described in Annex 7 and compared with the SRTT shall be as follows:

Class of tyre	Snow grip index (brake on snow method) <sup>(a)</sup>		Snow grip index (spin traction method) <sup>(b)</sup>	Snow grip index (acceleration method) <sup>(c)</sup>
	Ref. = C1 – SRTT 14	Ref. = C2 – SRTT 16C	Ref. = C1 – SRTT 14	Ref. = C3N – SRTT 19.5 Ref. = C3W – SRTT 22.5
C1	1.07	No	1.10	No
C2	No	1.02	1.10	No
C3	No	No	No	1.25

<sup>(a)</sup> See paragraph 3. of Annex 7 to this Regulation

<sup>(b)</sup> See paragraph 2. of Annex 7 to this Regulation

<sup>(c)</sup> See paragraph 4. of Annex 7 to this Regulation

6.5. In order to be classified as a "traction tyre", a tyre is required to meet at least one of the conditions of paragraph 6.5.1. below.

6.5.1. The tyre shall have a tread pattern with minimum two circumferential ribs, each containing a minimum of 30 block-like elements, separated by grooves and/or sipe elements the depth of which has to be minimum of one half of the tread depth. The use of an alternative option of a physical test will only apply at a later stage following a further amendment to the Regulation including a reference to an appropriate test methods and limit values.

6.6. In order to be classified as a "special use tyre" a tyre shall have a block tread pattern in which the blocks are larger and more widely spaced than for normal tyres and have the following characteristics:

For C1 tyres: a tread depth  $\geq$  11 mm and void to fill ratio  $\geq$  35 per cent

For C2 tyres: a tread depth  $\geq$  11 mm and void to fill ratio  $\geq$  35 per cent

For C3 tyres: a tread depth  $\geq$  16 mm and void to fill ratio  $\geq$  35 per cent

- 6.7. In order to be classified as a "professional off-road tyre", a tyre shall have all of the following characteristics:
- (a) For C1 and C2 tyres:
    - (i) A tread depth  $\geq 11$  mm;
    - (ii) A void-to-fill ratio  $\geq 35$  per cent;
    - (iii) A maximum speed rating of  $\leq Q$ .
  - (b) For C3 tyres:
    - (i) A tread depth  $\geq 16$  mm;
    - (ii) A void-to-fill ratio  $\geq 35$  per cent;
    - (iii) A maximum speed rating of  $\leq K$ .

## **7. Modifications of the type of pneumatic tyre and extension of approval**

- 7.1. Every modification of the type of tyre, which may influence the performance characteristics approved in accordance with this Regulation, shall be notified to the Type Approval Authority which approved the type of tyre. That Authority may either:
- 7.1.1. Consider that the modifications are unlikely to have any appreciable adverse effect on the performance characteristics approved and that the tyre will comply with the requirements of this Regulation; or
  - 7.1.2. Require further samples to be submitted for test or further test reports from the designated Technical Service.
  - 7.1.3. Confirmation or refusal of approval, specifying the modifications, shall be communicated by the procedure given in paragraph 5.3. of this Regulation to the Parties to the Agreement which apply this Regulation.
  - 7.1.4. The Type Approval Authority granting the extension of approval shall assign a series number for such an extension which shall be shown on the communication form.

## **8. Conformity of production**

The conformity of production procedures shall comply with those set out in the Agreement, Appendix 2 (E/ECE/324-E/ECE/TRANS/505/Rev.2) with the following requirements:

- 8.1. Any tyre approved under this Regulation shall be so manufactured as to conform to the performance characteristics of the type of tyre approved and satisfy the requirements of paragraph 6. above;
- 8.2. In order to verify conformity as prescribed in paragraph 8.1. above, a random sample of tyres bearing the approval mark required by this Regulation shall be taken from the series production. The normal frequency of verification of conformity of production shall be at least once every two years;

- 8.2.1. In the case of verifications with regard to approvals in accordance with paragraph 6.2. of this Regulation, these shall be carried out using the same procedure (see Annex 5 to this Regulation) as that adopted for original approval, and the Type Approval Authority shall satisfy itself that all tyres falling within an approved type comply with the approval requirement. The assessment shall be based upon the production volume of the tyre type at each manufacturing facility, taking into account the quality management system(s) operated by the manufacturer. Where the test procedure involves testing a number of tyres at the same time, for example a set of four tyres for the purpose of testing wet grip performance in accordance with the standard vehicle procedure given in Annex 5 to this Regulation, then the set shall be considered as being one unit for the purposes of calculating the number of tyres to be tested.
- 8.3. Production shall be deemed to conform to the requirements of this Regulation if the levels measured comply with the limits prescribed in paragraph 6.1. of this Regulation, with an additional allowance of +1 dB(A) for possible mass production variations.
- 8.4. Production shall be deemed to conform to the requirements of this Regulation if the levels measured comply with the limits prescribed in paragraph 6.3. of this Regulation, with an additional allowance of +0.3 N/kN for possible mass production variations.

## **9. Penalties for non-conformity of production**

- 9.1. The approval granted in respect of a type of tyre pursuant to this Regulation may be withdrawn if the requirements laid down in paragraph 8. above are not complied with, or if any tyre of the type of tyre exceeds the limits given in paragraph 8.3. or 8.4. above.
- 9.2. If a Party to the Agreement, which applies this Regulation, withdraws an approval, it has previously granted, it shall forthwith notify the other Contracting Parties applying this Regulation by means of a copy of the approval form conforming to the model in Annex 1 to this Regulation.

## **10. Production definitively discontinued**

If the holder of an approval completely ceases to manufacture a type of pneumatic tyre approved in accordance with this Regulation, he shall so inform the Type Approval Authority, which granted the approval. Upon receiving the relevant communication that Authority shall inform thereof the other Parties to the 1958 Agreement applying this Regulation by means of a communication form conforming to the model in Annex 1 to this Regulation.

## **11. Names and addresses of Technical Services responsible for conducting approval tests of Type Approval Authorities**

The Parties to the Agreement which apply this Regulation shall communicate to the United Nations Secretariat, the names and addresses of the Technical Services conducting approval tests and of the Type Approval Authority which grant approval and to which forms certifying approval or extension of approval or refusal or withdrawal of approval, issued in other countries, are to be sent.

## **12. Transitional provisions**

- 12.1. As from the date of entry into force of the 02 series of amendments to this Regulation, Contracting Parties applying this Regulation shall not refuse to grant approval under this Regulation for a type of tyre if the tyre complies with the requirements of the 02 series of amendments, including the stage 1 or stage 2 rolling sound requirements set out in paragraphs 6.1.1. to 6.1.3. of this Regulation, the requirements for wet grip performance set out in paragraph 6.2.1. of this Regulation, and the stage 1 or stage 2 rolling resistance requirements set out in paragraph 6.3.1. or 6.3.2. of this Regulation.
- 12.2. As from 1 November 2012, Contracting Parties applying this Regulation shall refuse to grant approval if the tyre type to be approved does not meet the requirements of this Regulation as amended by the 02 series of amendments, and shall, in addition, refuse to grant approval if the stage 2 rolling sound requirements set out in paragraphs 6.1.1. to 6.1.3. of this Regulation, the requirements for wet grip performance set out in paragraph 6.2.1. of this Regulation, and the stage 1 rolling resistance requirements set out in paragraph 6.3.1. of this Regulation are not complied with.
- 12.3. As from 1 November 2014, Contracting Parties applying this Regulation may refuse to allow the sale or entry into service of a tyre which does not meet the requirements of this Regulation as amended by the 02 series, and which does not meet the requirements of this Regulation as amended by the 02 series of amendments including the wet grip performance requirements set out in paragraph 6.2.1. of this Regulation.
- 12.4. As from 1 November 2016, Contracting Parties applying this Regulation shall refuse to grant approvals if the tyre type to be approved does not meet the requirements of this Regulation as amended by the 02 series of amendments including the stage 2 rolling resistance requirements set out in paragraph 6.3.2. of this Regulation and the wet grip requirements set out in paragraphs 6.2.2. and 6.2.3. of this Regulation.
- 12.5. As from 1 November 2016, any Contracting Party applying this Regulation may refuse to allow the sale or entry into service of a tyre which does not meet the requirements of this Regulation as amended by the 02 series, and which does not meet the stage 2 rolling sound requirements set out in paragraphs 6.1.1. to 6.1.3. of this Regulation.

- 12.6. As from the dates given below, any Contracting Party applying this Regulation may refuse to allow the sale or entry into service of a tyre which does not meet the requirements of this Regulation as amended by the 02 series, and which does not meet the stage 1 rolling resistance requirements set out in paragraph 6.3.1. of this Regulation:

<i>Tyre class</i>	<i>Date</i>
C1, C2	1 November 2014
C3	1 November 2016

- 12.7. As from the dates given below, any Contracting Party applying this Regulation may refuse to allow the sale or entry into service of a tyre which does not meet the requirements of this Regulation as amended by the 02 series, and which does not meet the stage 2 rolling resistance requirements set out in paragraph 6.3.2. of this Regulation and the wet grip requirements set out in paragraphs 6.2.2. and 6.2.3. of this Regulation:

<i>Tyre class</i>	<i>Date</i>
C1 and C2	1 November 2018
C3	1 November 2020

- 12.8. Until 13 February 2019 (60 months after the entry into force of Supplement 4 to the 02 series of amendments to this Regulation) Contracting Parties applying this Regulation may continue to grant type approvals according to the 02 series of amendments to this Regulation, based on the provisions of Annex 4 to this Regulation.

## Annex 1

### Communication

(Maximum format: A4 (210 x 297 mm))



Issued by:      Name of administration:  
 .....  
 .....  
 .....

Concerning:<sup>2</sup>      Approval granted  
                          Approval extended  
                          Approval refused  
                          Approval withdrawn  
                          Production definitively discontinued

of a type of tyre with regard to "rolling sound emission level" and/or "adhesion performance on wet surfaces" and/or "rolling resistance" pursuant to Regulation No. 117

Approval No. ....      Extension No. ....

1.    Manufacturer's name and address(es): .....
2.    If applicable, name and address of manufacturer's representative: .....
3.    "Tyre class" and "category of use" of the type of tyre: .....
- 3.1.    Snow tyre for use in severe snow conditions (Yes/No)<sup>2</sup>
- 3.2.    Traction tyre (Yes/No)<sup>2</sup>
4.    Brand(s) name(s) and/or Trade description(s) of the type of tyre: .....
5.    Technical Service and, where appropriate, test laboratory approved for purposes of approval or of verification of conformity tests: .....
6.    Performance(s) approved: sound level at (stage 1/stage 2),<sup>2</sup> wet adhesion level, rolling resistance level (stage 1/stage 2)<sup>2</sup>
  - 6.1.    Sound level of the representative tyre size, see paragraph 2.5. of this Regulation, as per item 7. of the test report in Appendix 1 to Annex 3: ..... dB(A) at reference speed of 70/80 km/h<sup>2</sup>
  - 6.2.    Wet adhesion level of the representative tyre size, see paragraph 2.5. of this Regulation, as per item 7. of the test report in the appendix to Annex 5: ..... (G) using the vehicle or trailer method<sup>2</sup>

<sup>1</sup> Distinguishing number of the country which has granted/extended/refused/withdrawn approval (see approval provisions in the Regulation).

<sup>2</sup> Strike out what does not apply.

- 6.3. Rolling resistance level of the representative tyre size, see paragraph 2.5. of this Regulation, as per item 7. of the test report in Appendix 1 to Annex 6 .....
- 6.4. Snow grip level of the representative tyre size, see paragraph 2.5. of Regulation No. 117, as per item 7. of the test report in the appendix<sup>3</sup> to Annex 7:.....  
(Snow grip index) using the brake on snow method<sup>2</sup>, spin traction method<sup>2</sup> or acceleration method.<sup>2</sup>
7. Number of report issued by the Technical Service: .....
8. Date of report issued by that Service: .....
9. Reason(s) of extension (if applicable): .....
10. Any remarks:.....
11. Place: .....
12. Date: .....
13. Signature: .....
14. Annexed to this communication are: .....
- 14.1. A list of documents in the approval file deposited at the Type Approval Authorities having delivered the approval and which can be obtained upon request. <sup>4</sup>
- 14.2. A list of tread-pattern designations: Specify for each trademark or brand name and trade description the list of tyre size designations, adding in case of Class C1 tyres the mark "reinforced" (or "extra load") or the speed symbol of snow tyres or in the case of tyres of Classes C2 and C3, the mark "traction", if so required by paragraph 3.1. of this Regulation.

---

<sup>3</sup> Appendix 2 for C1 and C2 tyres.  
Appendix 3 for C3 tyres.

<sup>4</sup> In the case of "snow tyre for use in severe snow conditions" a test report according to Appendix 2 to Annex 7 shall be submitted.

## Annex 2 - Appendix 1

### Example of approval marks

Arrangements of approval marks

(See paragraph 5.4. of this Regulation)

Approval according to Regulation No. 117

Example 1

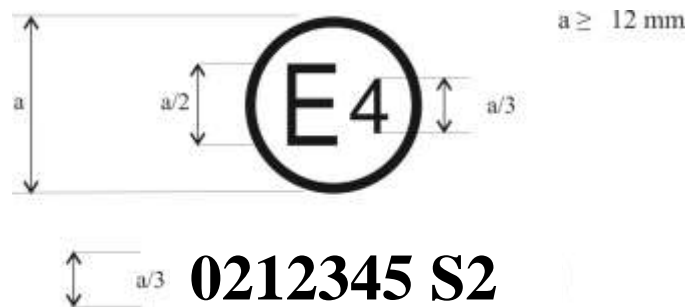

The above approval mark, affixed to a pneumatic tyre shows that a tyre concerned has been approved in the Netherlands (E 4) pursuant to Regulation No. 117 (marked by S2 (rolling sound at stage 2) only), under approval number 0212345. The first two digits of the approval number (02) indicate that the approval was granted according to the requirements 02 series of amendments to this Regulation.

Example 2

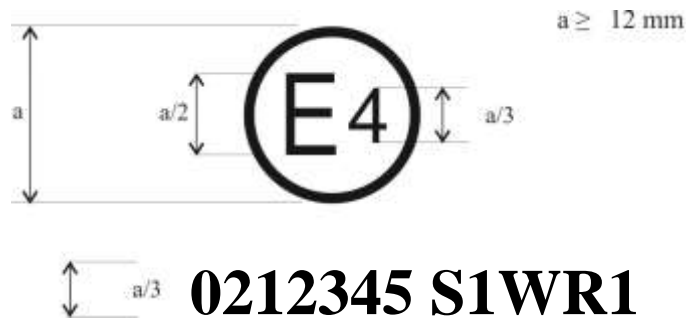

The above approval mark shows that the tyre concerned has been approved in the Netherlands (E 4) pursuant to Regulation No. 117 (marked by S1 (rolling sound at stage 1) W (wet adhesion), and R1 ( Rolling resistance at stage 1 ) under approval number 0212345. This indicates that the approval is for S1WR1. The first two digits of the approval number (02) indicate that the approval was granted according to the requirements of the 02 series of amendments to this Regulation.



## Annex 2 - Appendix 2

### Approval according to Regulation No. 117 coincident with approval of Regulation No. 30 or 54<sup>1</sup>

Example 1

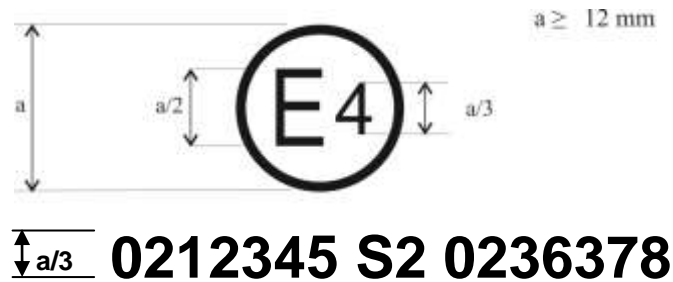

The above approval mark shows that the tyre concerned has been approved in the Netherlands (E 4) pursuant to Regulation No. 117 (marked by S2 (rolling sound at stage 2)), under approval number 0212345 and Regulation No. 30, under approval number 0236378. The first two digits of the approval number (02) indicate that the approval was granted according to the 02 series of amendments and Regulation No. 30 included the 02 series of amendments.

<sup>1</sup> Approvals in accordance with Regulation No. 117 for tyres within the scope of Regulation No. 54 currently do not include wet adhesion requirements.

Example 2

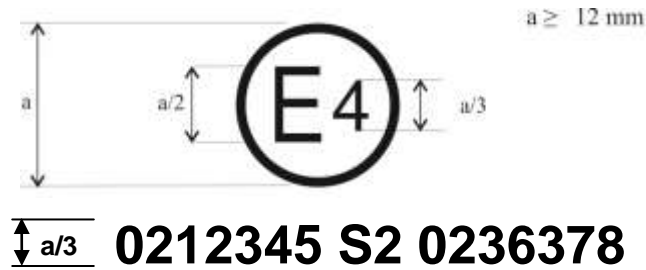

or



**0212345 S2WR2**



**0236378**

The above approval mark shows that the tyre concerned has been approved in the Netherlands (E 4) pursuant to Regulation No. 117 (marked by S2WR2 (rolling sound at stage 2 wet adhesion and rolling resistance at stage 2)), under approval number 0212345 and Regulation No. 30 under approval number 0236378. The first two digits of the approval number (02) indicate that the approval was granted according to the 02 series of amendments and Regulation No. 30 included the 02 series of amendments.

Example 3

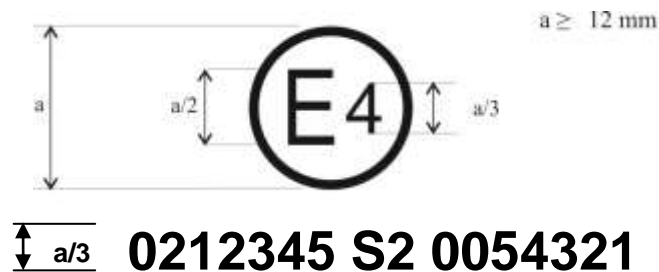

The above approval mark shows that the tyre concerned has been approved in the Netherlands (E 4) pursuant to Regulation No. 117 and the 02 series of amendments under approval number 0212345 (marked by S2), and Regulation No. 54. This indicates that the approval is for rolling sound stage 2 (S2). The first two digits of the Regulation No. 117 approval number (02) in conjunction with "S2" indicate that the first approval was granted in accordance with Regulation No. 117 which included the 02 series of amendments. The first two digits of Regulation No. 54 (00) indicate that this Regulation was in its original form.

Example 4



$a/3$  0212345 S2 0054321

The above approval mark shows that the tyre concerned has been approved in the Netherlands (E 4) pursuant to Regulation No. 117 and the 02 series of amendments under approval number 0212345 (marked by S2 R2), and Regulation No. 54. This indicates that the approval is for rolling sound stage 2 (S2) and rolling resistance stage 2. The first two digits of the Regulation No. 117 approval number (02) in conjunction with "S2R2" indicate that the first approval was granted in accordance with Regulation No. 117 which included the 02 series of amendments. The first two digits of Regulation No. 54 (00) indicate that this Regulation was in its original form.

## Annex 2 - Appendix 3

### Extensions to combine approvals issued in accordance with Regulations Nos. 117, 30 or 54<sup>1</sup>

Example 1

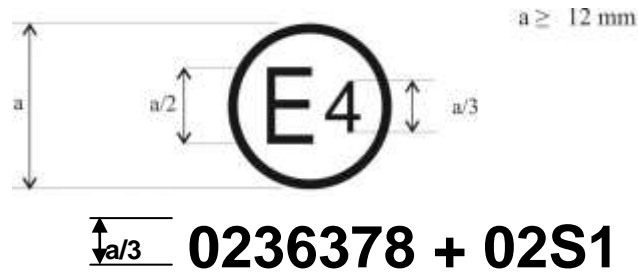

The above approval mark shows that the tyre concerned has been initially approved in the Netherlands (E 4) pursuant to Regulation No. 30 and the 02 series of amendments under approval number 0236378. It is also marked by + 02S1 (rolling sound at stage 1) which indicates that its approval is extended under Regulation No. 117 (02 series of amendments). The first two digits of the approval number (02) indicate that the approval was granted according to Regulation No. 30 (02 series of amendments). The addition (+) sign indicates that the first approval was granted in accordance with Regulation No. 30 and has been extended to include the approval(s) granted according to Regulation No. 117 (02 series of amendments) for rolling sound at stage 1.

Example 2

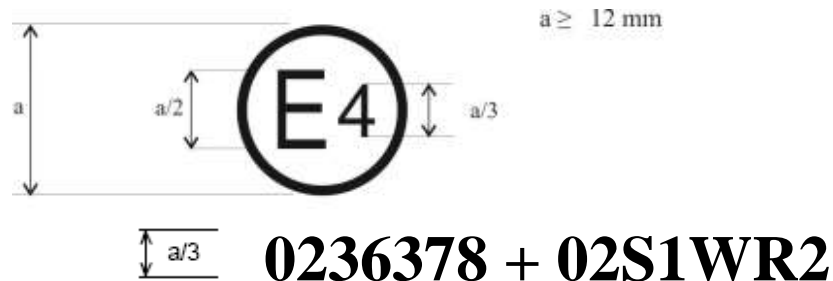

The above approval mark shows that the tyre concerned has been initially approved in the Netherlands (E 4) pursuant to Regulation No. 30 and the 02 series of amendments under approval number 0236378. This indicates that the approval is for S1 (rolling sound at stage 1) W (wet adhesion) and R2 (rolling resistance at stage 2). The S1WR2 preceded by (02) indicates that it has had its approval extended under Regulation No. 117 which included the 02 series of amendments. The first two digits of the approval number (02) indicate that the approval was granted according to Regulation No. 30 (02 series of amendments). The addition (+) sign indicates that the first approval was granted in accordance with Regulation No. 30 and has been extended to include Regulation No. 117 approval(s) (02 series of amendments).

---

<sup>1</sup> Approvals in accordance with Regulation No. 117 for tyres within the scope of Regulation No. 54 currently do not include wet adhesion requirements.

## Annex 2 - Appendix 4

### Extensions to combine approvals issued in accordance with Regulation No. 117<sup>1</sup>

Example 1



$\overline{a/3}$  **0212345 W + S2R2**

The above approval mark shows that the tyre concerned has been initially approved in the Netherlands (E 4) pursuant to Regulation No. 117 and the 02 series of amendments under approval number 0212345. This indicates that the approval is for W (wet grip). The S2R2 preceded by + indicates that it has had its approval extended under Regulation No. 117 to rolling sound at stage 2 and rolling resistance at stage 2 based on separate certificate(s).

Example 2

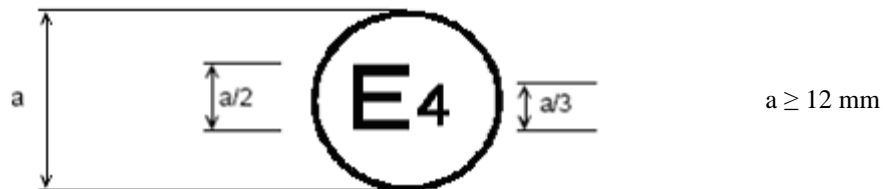

$\overline{a/3}$  **0212345 S1W + R1**

The above approval mark shows that the tyre concerned has been initially approved in the Netherlands (E 4) pursuant to Regulation No. 117 and the 02 series of amendments under approval number 0212345. This indicates that the approval is for S1 (rolling sound at stage 1) and W (wet grip). The R1 preceded by + indicates that it has had its approval extended under Regulation No. 117 to rolling resistance at stage 1 based on separate certificate(s).

<sup>1</sup> Approvals in accordance with Regulation No. 117 for tyres within the scope of Regulation No. 54 currently do not include wet adhesion requirements.



$\frac{a}{3}$  **0167890 SW + 02R1**

The above approval mark shows that the tyre concerned has been initially approved in the Netherlands (E 4) pursuant to Regulation No. 117 and the 01 series of amendments under approval number 0167890. This indicates that the approval is for S (rolling sound at stage 1) and W (wet grip). The 02R1 preceded by + indicates that it has had its approval extended under Regulation No. 117 and the 02 series of amendments to rolling resistance at stage 1 based on separate certificate(s).

## Annex 3

### Coast-by test method for measuring tyre-rolling sound emission

#### Introduction

The presented method contains specifications on measuring instruments, measurement conditions and the measurement method, in order to obtain the sound level of a set of tyres mounted on a test vehicle rolling on a specified road surface. The maximum sound pressure level is to be recorded, when the test vehicle is coasting, by remote-field microphones; the final result for a reference speed is obtained from a linear regression analysis. Such test results cannot be related to tyre rolling sound measured during acceleration under power or deceleration under braking.

#### 1. Measuring instruments

##### 1.1. Acoustic measurements

The sound level meter or the equivalent measuring system, including the windscreen recommended by the manufacturer shall meet or exceed the requirements of Type 1 instruments in accordance with IEC 60651:1979/A1:1993, second edition.

The measurements shall be made using the frequency weighting A, and the time weighting F.

When using a system that includes a periodic monitoring of the A-weighted sound level, a reading should be made at a time interval not greater than 30 ms.

##### 1.1.1. Calibration

At the beginning and at the end of every measurement session, the entire measurement system shall be checked by means of a sound calibrator that fulfils the requirements for sound calibrators of at least precision Class 1 according to IEC 60942:1988. Without any further adjustment the difference between the readings of two consecutive checks shall be less than or equal to 0.5 dB(A). If this value is exceeded, the results of the measurements obtained after the previous satisfactory check shall be discarded.

##### 1.1.2. Compliance with requirements

The compliance of the sound calibration device with the requirements of IEC 60942:1988 shall be verified once a year and the compliance of the instrumentation system with the requirements of IEC 60651:1979/A1:1993, second edition shall be verified at least every two years, by a laboratory which is authorized to perform calibrations traceable to the appropriate standards.

- 1.1.3.        Positioning of the microphone
- The microphone (or microphones) shall be located at a distance of  $7.5 \pm 0.05$  m from track reference line CC' (Figure 1) and  $1.2 \pm 0.02$  m above the ground. Its axis of maximum sensitivity shall be horizontal and perpendicular to the path of the vehicle (line CC').
- 1.2.         Speed measurements
- The vehicle speed shall be measured with instruments with accuracy of  $\pm 1$  km/h or better when the front end of the vehicle has reached line PP (Figure 1).
- 1.3.         Temperature measurements
- Measurements of air as well as test surface temperature are mandatory.
- The temperature measuring devices shall be accurate within  $\pm 1$  °C.
- 1.3.1.       Air temperature
- The temperature sensor is to be positioned in an unobstructed location close to the microphone in such a way that it is exposed to the airflow and protected from direct solar radiation. The latter may be achieved by any shading screen or similar device. The sensor should be positioned at a height of  $1.2 \pm 0.1$  m above the test surface level, to minimize the influence of the test surface thermal radiation at low airflows.
- 1.3.2.       Test surface temperature
- The temperature sensor is to be positioned in a location where the temperature measured is representative of the temperature in the wheel tracks, without interfering with the sound measurement.
- If an instrument with a contact temperature sensor is used, heat-conductive paste shall be applied between the surface and the sensor to ensure adequate thermal contact.
- If a radiation thermometer (pyrometer) is used, the height should be chosen to ensure that a measuring spot with a diameter of  $\geq 0.1$  m is covered.
- 1.4.         Wind measurement
- The device shall be capable of measuring the wind speed with a tolerance of  $\pm 1$  m/s. The wind shall be measured at microphone height. The wind direction with reference to the driving direction shall be recorded.
2.           Conditions of measurement
- 2.1.         Test site
- The test site shall consist of a central section surrounded by a substantially flat test area. The measuring section shall be level; the test surface shall be dry and clean for all measurements. The test surface shall not be artificially cooled during or prior the testing.
- The test track shall be such that the conditions of a free sound field between the sound source and the microphone are attained to within 1 dB(A). These conditions shall be deemed to be met if there is no large sound reflecting objects, such as fences, rocks, bridges or building within 50 m of the centre of the measuring section. The surface of the test track and the dimensions of



the test site shall be in accordance with ISO 10844:2014. Until the end of the period indicated in paragraph 12.8. of this Regulation the specifications for the test site may be in accordance with Annex 4 to this Regulation.

A central part of at least 10 m radius shall be free of powdery snow, tall grass, loose soil, cinders or the like. There shall be no obstacle, which could affect the sound field within the vicinity of the microphone and no persons shall stand between the microphone and the sound source. The operator carrying out the measurements and any observers attending the measurements shall position themselves so as not to affect the readings of the measuring instruments.

2.2. Meteorological conditions

Measurements shall not be made under poor atmospheric conditions. It shall be ensured that the results are not affected by gusts of wind. Testing shall not be performed if the wind speed at the microphone height exceeds 5 m/s.

Measurements shall not be made if the air temperature is below 5 °C or above 40 °C or the test surface temperature is below 5 °C or above 50 °C.

2.3. Ambient noise

2.3.1. The background sound level (including any wind noise) shall be at least 10 dB(A) less than the measured tyre rolling sound emission. A suitable windscreen may be fitted to the microphone provided that account is taken of its effect on the sensitivity and directional characteristics of the microphone.

2.3.2. Any measurement affected by a sound peak which appears to be unrelated to the characteristics of the general sound level of tyres, shall be ignored.

2.4. Test vehicle requirements

2.4.1. General

The test vehicle shall be a motor vehicle and be fitted with four single tyres on just two axles.

2.4.2. Vehicle load

The vehicle shall be loaded such as to comply with the test tyre loads as specified in paragraph 2.5.2. below.

2.4.3. Wheelbase

The wheelbase between the two axles fitted with the test tyres shall for Class C1 be less than 3.50 m and for Class C2 and Class C3 tyres be less than 5 m.

2.4.4. Measures to minimize vehicle influence on sound level measurements

To ensure that tyre rolling sound is not significantly affected by the test vehicle design the following requirements and recommendations are given.

2.4.4.1. Requirements:

- (a) Spray suppression flaps or other extra device to suppress spray shall not be fitted;
- (b) Addition or retention of elements in the immediate vicinity of the rims and tyres, which may screen the emitted sound, is not permitted;
- (c) Wheel alignment (toe in, camber and caster) shall be in full accordance with the vehicle manufacturer's recommendations;

- (d) Additional sound absorbing material may not be mounted in the wheel housings or under the underbody;
- (e) Suspension shall be in such a condition that it does not result in an abnormal reduction in ground clearance when the vehicle is loaded in accordance with the testing requirement. If available, body level Regulation systems shall be adjusted to give a ground clearance during testing which is normal for unladen condition.

2.4.4.2. Recommendations to avoid parasitic noise:

- (a) Removal or modification on the vehicle that may contribute to the background noise of the vehicle is recommended. Any removals or modifications shall be recorded in the test report;
- (b) During testing it should be ascertained that brakes are not poorly released, causing brake noise;
- (c) It should be ascertained that electric cooling fans are not operating;
- (d) Windows and sliding roof of the vehicle shall be closed during testing.

2.5. Tyres

2.5.1. General

Four identical tyres shall be fitted on the test vehicle. In the case of tyres with a load capacity index in excess of 121 and without any dual fitting indication, two of these tyres of the same type and range shall be fitted to the rear axle of the test vehicle; the front axle shall be fitted with tyres of size suitable for the axle load and planed down to the minimum depth in order to minimize the influence of tyre/road contact noise while maintaining a sufficient level of safety. Winter tyres that in certain Contracting Parties may be equipped with studs intended to enhance friction shall be tested without this equipment. Tyres with special fitting requirements shall be tested in accordance with these requirements (e.g. rotation direction). The tyres shall have full tread depth before being run-in.

Tyres are to be tested on rims permitted by the tyre manufacturer.

2.5.2. Tyre loads

The test load  $Q_t$  for each tyre on the test vehicle shall be 50 to 90 per cent of the reference load  $Q_r$ , but the average test load  $Q_{t,avr}$  of all tyres shall be  $75 \pm 5$  per cent of the reference load  $Q_r$ .

For all tyres the reference load  $Q_r$  corresponds to the maximum mass associated with the load capacity index of the tyre. In the case where the load capacity index is constituted by two numbers divided by slash (/), reference shall be made to the first number.

2.5.3. Tyre inflation pressure

Each tyre fitted on the test vehicle shall have a test pressure  $P_t$  not higher than the reference pressure  $P_r$  and within the interval:

$$P_r \times \left( \frac{Q_t}{Q_r} \right)^{1.25} \leq P_t \leq 1.1 P_r \times \left( \frac{Q_t}{Q_r} \right)^{1.25}$$

For Class C2 and Class C3 the reference pressure  $P_r$  is the pressure corresponding to the pressure index marked on the sidewall.

For Class C1 the reference pressure is  $P_r = 250$  kPa for "standard" tyres and 290 kPa for "reinforced" or "extra load" tyres; the minimum test pressure shall be  $P_t = 150$  kPa.

2.5.4. Preparations prior to testing

The tyres shall be "run-in" prior to testing to remove compound nodules or other tyre pattern characteristics resulting from the moulding process. This will normally require the equivalent of about 100 km of normal use on the road.

The tyres fitted to the test vehicle shall rotate in the same direction as when they were run-in.

Prior to testing tyres shall be warmed up by running under test conditions.

3. Method of testing

3.1. General conditions

For all measurements the vehicle shall be driven in a straight line over the measuring section (AA' to BB') in such a way that the median longitudinal plane of the vehicle is as close as possible to the line CC'.

When the front end of the test vehicle has reached the line AA' the vehicle driver shall have put the gear selector on neutral position and switched off the engine. If abnormal noise (e.g. ventilator, self-ignition) is emitted by the test vehicle during the measurement, the test shall be disregarded.

3.2. Nature and number of measurements

The maximum sound level expressed in A-weighted decibels (dB(A)) shall be measured to the first decimal place as the vehicle is coasting between lines AA' and BB' (Figure 1 - front end of the vehicle on line AA', rear end of the vehicle on line BB'). This value will constitute the result of the measurement.

At least four measurements shall be made on each side of the test vehicle at test speeds lower than the reference speed specified in paragraph 4.1. below and at least four measurements at test speeds higher than the reference speed. The speeds shall be approximately equally spaced over the speed range specified in paragraph 3.3. below.

3.3. Test speed range

The test vehicle speeds shall be within the range:

- (a) From 70 to 90 km/h for Class C1 and Class C2 tyres;
- (b) From 60 to 80 km/h for Class C3 tyres.

4. Interpretation of results

The measurement shall be invalid if an abnormal discrepancy between the values is recorded (see paragraph 2.3.2. of this annex).

4.1. Determination of test result

Reference speed  $V_{ref}$  used to determine the final result will be:

- (a) 80 km/h for Class C1 and Class C2 tyres;
- (b) 70 km/h for Class C3 tyres.

4.2. Regression analysis of rolling sound measurements

The tyre-road rolling sound level  $L_R$  in dB(A) is determined by a regression analysis according to:

$$L_R = \bar{L} - a \cdot \bar{v}$$

Where:

$\bar{L}$  is the mean value of the rolling sound levels  $L_i$ , measured in dB(A):

$$\bar{L} = \frac{1}{n} \sum_{i=1}^n L_i$$

$n$  is the measurement number ( $n \geq 16$ ),

$\bar{v}$  is the mean value of logarithms of speeds  $V_i$ :

$$\bar{v} = \frac{1}{n} \sum_{i=1}^n v_i \quad \text{with} \quad v_i = \lg\left(\frac{V_i}{V_{ref}}\right)$$

$a$  is the slope of the regression line in dB(A):

$$a = \frac{\sum_{i=1}^n (v_i - \bar{v})(L_i - \bar{L})}{\sum_{i=1}^n (v_i - \bar{v})^2}$$

4.3. Temperature correction

For Class C1 and Class C2 tyres, the final result shall be normalized to a test surface reference temperature  $\vartheta_{ref}$  by applying a temperature correction, according to the following:

$$L_R(\vartheta_{ref}) = L_R(\vartheta) + K(\vartheta_{ref} - \vartheta)$$

Where:

$\vartheta$  = the measured test surface temperature,

$\vartheta_{ref}$  = 20 °C,

For Class C1 tyres, the coefficient  $K$  is: -0.03 dB(A)/°C, when  $\vartheta > \vartheta_{ref}$

and -0.06 dB(A)/°C when  $\vartheta < \vartheta_{ref}$ .

For Class C2 tyres, the coefficient  $K$  is -0.02 dB(A)/°C

If the measured test surface temperature does not change more than 5 °C within all measurements necessary for the determination of the sound level of one set of tyres, the temperature correction may be made only on the final reported tyre rolling sound level as indicated above, utilizing the arithmetic mean value of the measured temperatures. Otherwise each measured sound level  $L_i$  shall be corrected, utilizing the temperature at the time of the sound recording.

There will be no temperature correction for Class C3 tyres.

- 4.4. In order to take account of any measuring instrument inaccuracies, the results according to paragraph 4.3. above shall be reduced by 1 dB(A).
- 4.5. The final result, the temperature corrected tyre rolling sound level  $L_R(9_{ref})$  in dB(A), shall be rounded down to the nearest lower whole value.

Figure 1  
Microphone positions for the measurement

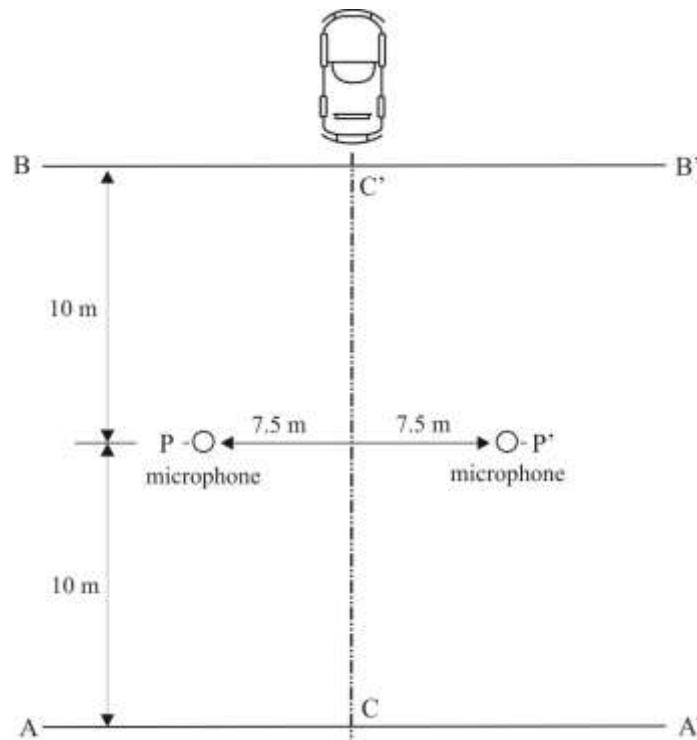

## Annex 3 - Appendix 1

### Test report

#### Part 1 - Report

1. Type Approval Authority or Technical Service: .....
2. Name and address of applicant: .....  
.....
3. Test report No.: .....
4. Manufacturer and Brand Name or Trade description: .....
5. Tyre Class (C1, C2 or C3): .....
6. Category of use: .....
7. Sound level according to paragraphs 4.4. and 4.5. of Annex 3: ..... dB(A)  
at reference speed of 70/80 km/h<sup>1</sup>
8. Comments (if any): .....  
.....
9. Date: .....
10. Signature: .....

#### Part 2 - Test data

1. Date of test: .....
2. Test vehicle (Make, model, year, modifications, etc.): .....  
.....
- 2.1. Test vehicle wheelbase: ..... mm
3. Location of test track: .....
- 3.1. Date of track certification to ISO 10844:2014: .....
- 3.2. Issued by: .....
- 3.3. Method of certification: .....
4. Tyre test details: .....
- 4.1. Tyre size designation: .....
- 4.2. Tyre service description: .....
- 4.3. Reference inflation pressure: ..... kPa

---

<sup>1</sup> Strike out what does not apply.

4.4. Test data: .....

	<i>Front left</i>	<i>Front right</i>	<i>Rear left</i>	<i>Rear right</i>
Test mass (kg)				
Tyre load index (%)				
Inflation pressure (cold) (kPa)				

4.5. Test rim width code: .....

4.6. Temperature measurement sensor type: .....

5. Valid test results: .....

<i>Run No.</i>	<i>Test speed km/h</i>	<i>Direction of run</i>	<i>Sound level left<sup>1</sup> measured dB(A)</i>	<i>Sound level right<sup>1</sup> measured dB(A)</i>	<i>Air temp. °C</i>	<i>Track temp. °C</i>	<i>Sound level left<sup>1</sup> temp. corrected dB(A)</i>	<i>Sound level right<sup>1</sup> temp. corrected dB(A)</i>	<i>Comments</i>
1									
2									
3									
4									
5									
6									
7									
8									

<sup>1</sup> Relative to the vehicle.

5.1. Regression line slope: .....

5.2. Sound level after temperature correction according to paragraph 4.3. of Annex 3:  
..... dB(A)

## Annex 4

### Specifications for the test site<sup>1</sup>

1. Introduction

This annex describes the specifications relating to the physical characteristics and the laying of the test track. These specifications based on a special standard<sup>2</sup> describe the required physical characteristics as well as the test methods for these characteristics.

2. Required characteristics of the surface

A surface is considered to conform to this standard provided that the texture and voids content or sound absorption coefficient have been measured and found to fulfil all the requirements of paragraphs 2.1. to 2.4. below and provided that the design requirements (paragraph 3.2. below) have been met.

2.1. Residual voids content

The residual Voids Content (VC) of the test track paving mixture shall not exceed 8 per cent. For the measurement procedure, see paragraph 4.1. of this annex.

2.2. Sound absorption coefficient

If the surface fails to comply with the residual voids content requirement, the surface is acceptable only if its sound absorption coefficient is  $\alpha \leq 0.10$ . For the measurement procedure, see paragraph 4.2. below. The requirements of this paragraph 2.1. above are met also if only sound absorption has been measured and found to be  $\alpha \leq 0.10$ .

*Note:* The most relevant characteristic is the sound absorption, although the residual voids content is more familiar among road constructors. However, sound absorption needs to be measured only if the surface fails to comply with the voids requirement. This is motivated because the latter is connected with relatively large uncertainties in terms of both measurements and relevance and some surfaces therefore erroneously may be rejected when based only on the voids measurement.

2.3. Texture depth

The Texture Depth (TD) measured according to the volumetric method (see paragraph 4.3. below) shall be:

$$TD \geq 0.4 \text{ mm}$$

---

<sup>1</sup> The specifications for the test site reproduced in this annex are valid until the end of the period indicated in paragraph 12.8. of this Regulation.

<sup>2</sup> ISO 10844:2014.



2.4. Homogeneity of the surface

Every practical effort shall be taken to ensure that the surface is made to be as homogeneous as possible within the test area. This includes the texture and voids content, but it should also be observed that if the rolling process results in more effective rolling at some places than others, the texture may be different and unevenness causing bumps may also occur.

2.5. Period of testing

In order to check whether the surface continues to conform to the texture and voids content or sound absorption requirements stipulated in this standard, periodic testing of the surface shall be done at the following intervals:

(a) For residual VC or sound absorption ( $\alpha$ ):

When the surface is new:

If the surface meets the requirements when new, no further periodical testing is required. If it does not meet the requirement when it is new, it may do so later because surfaces tend to become clogged and compacted with time;

(b) For TD:

When the surface is new:

When the noise testing starts (*Note*: Not before four weeks after laying);

Then every twelve months.

3. Test surface design

3.1. Area

When designing the test track layout it is important to ensure that, as a minimum requirement, the area traversed by the vehicles running through the test strip is covered with the specified test material with suitable margins for safe and practical driving. This will require that the width of the track is at least 3 m and the length of the track extends beyond lines AA and BB by at least 10 m at either end. Figure 1 shows a plan of a suitable test site and indicates the minimum area which shall be machine laid and machine compacted with the specified test surface material. According to Annex 3, paragraph 3.2., measurements have to be made on each side of the vehicle. This can be made either by measuring with two microphone locations (one on each side of the track) and driving in one direction, or measuring with a microphone only on one side of the track but driving the vehicle in two directions. If the latter method is used, then there are no surface requirements on that side of the track where there is no microphone.

Figure 1  
**Minimum requirements for test surface area. The shaded part is called "Test area"**

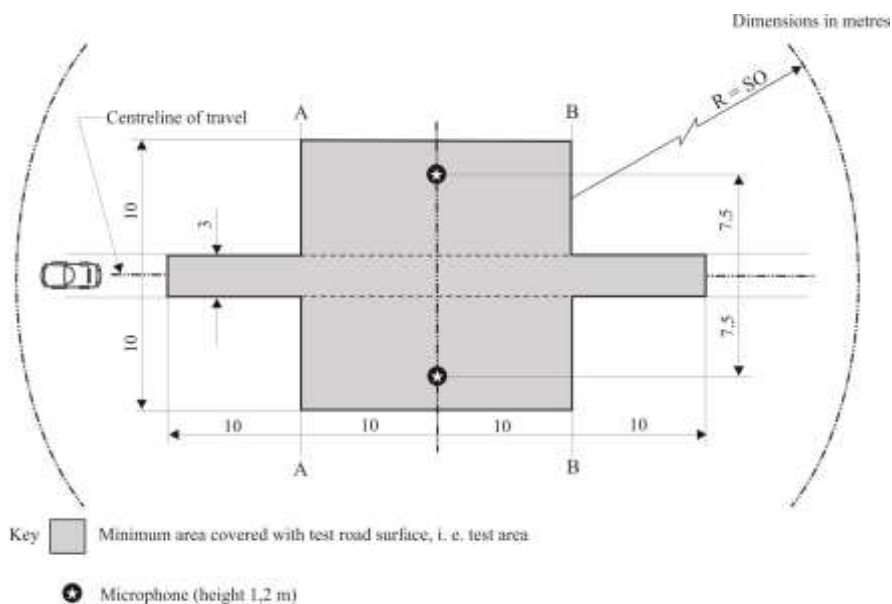

NOTE - There shall be no large acoustically reflective objects within this radius.

### 3.2. Design and preparation of the surface

#### 3.2.1. Basic design requirements

The test surface shall meet four design requirements:

3.2.1.1. It shall be a dense asphaltic concrete.

3.2.1.2. The maximum chipping size shall be 8 mm (tolerances allow from 6.3 mm to 10 mm).

3.2.1.3. The thickness of the wearing course shall be  $\geq 30$  mm.

3.2.1.4. The binder shall be a straight penetration grade bitumen without modification.

#### 3.2.2. Design guidelines

As a guide to the surface constructor, an aggregate grading curve which will give desired characteristics is shown in Figure 2. In addition, Table 1 gives some guidelines in order to obtain the desired texture and durability. The grading curve fits the following formula:

$$P (\% \text{ passing}) = 100 \cdot (d/d_{\max})^{1/2}$$

Where:

d = square mesh sieve size, in mm

$d_{\max}$  = 8 mm for the mean curve

= 10 mm for the lower tolerance curve

= 6.3 mm for the upper tolerance curve

Figure 2  
Grading curve of the aggregate in the asphaltic mix with tolerances

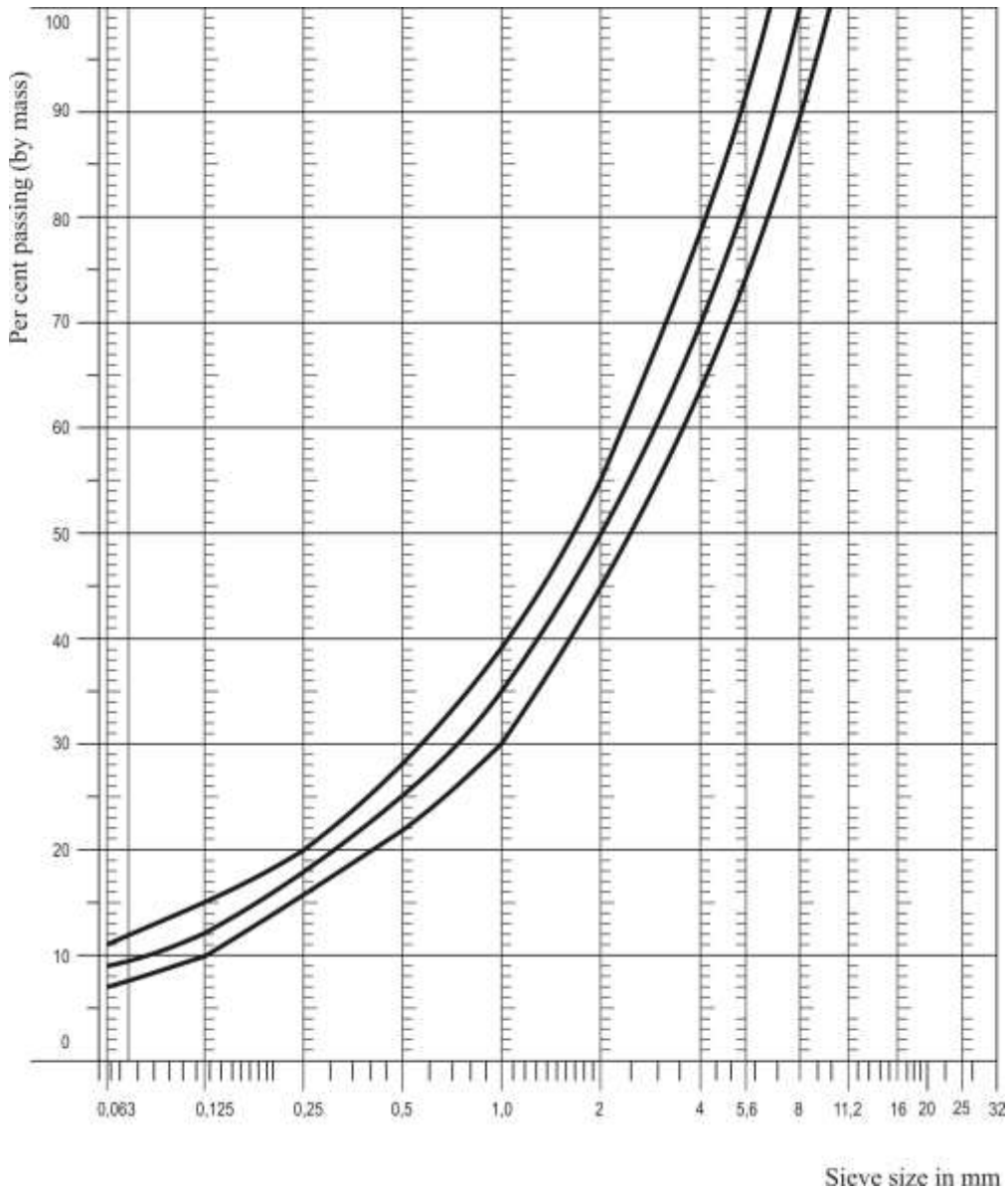

In addition to the above, the following recommendations are given:

- (a) The sand fraction (0.063 mm < square mesh sieve size < 2 mm) shall include no more than 55 per cent natural sand and at least 45 per cent crushed sand;
- (b) The base and sub-base shall ensure a good stability and evenness, according to best road construction practice;
- (c) The chippings shall be crushed (100 per cent crushed faces) and of a material with a high resistance to crushing;

- (d) The chippings used in the mix shall be washed;
- (e) No extra chippings shall be added onto the surface;
- (f) The binder hardness expressed as PEN value shall be 40 - 60, 60 - 80 or even 80 - 100 depending on the climatic conditions of the country. The rule is that as hard a binder as possible shall be used, provided this is consistent with common practice;
- (g) The temperature of the mix before rolling shall be chosen so as to achieve by subsequent rolling the required voids content. In order to increase the probability of satisfying the specifications of paragraphs 2.1. to 2.4. above, the compactness shall be studied not only by an appropriate choice of mixing temperature, but also by an appropriate number of passings and by the choice of compacting vehicle.

Table 1  
**Design guidelines**

	<i>Target values</i>		<i>Tolerances</i>
	<i>By total mass of mix</i>	<i>By mass of the aggregate</i>	
Mass of stones, square mesh sieve (SM) > 2 mm	47.6 %	50.5 %	±5 %
Mass of sand 0.063 < SM < 2 mm	38.0 %	40.2 %	±5 %
Mass of filler SM < 0.063 mm	8.8 %	9.3 %	±5 %
Mass of binder (bitumen)	5.8 %	N.A.	±0.5 %
Max. chipping size	8 mm		6.3 - 10 mm
Binder hardness	(see paragraph 3.2.2. (f))		
Polished Stone Value (PSV)	> 50		
Compactness, relative to Marshall Compactness	98 %		

4. Test method

4.1. Measurement of the residual voids content

For the purpose of this measurement, cores have to be taken from the track in at least four different positions, which are equally distributed in the test area between lines AA and BB (see Figure 1). In order to avoid inhomogeneity and unevenness in the wheel tracks, cores should not be taken in wheel tracks themselves, but close to them. Two cores (minimum) should be taken close to the wheel tracks and one core (minimum) should be taken approximately midway between the wheel tracks and each microphone location.

If there is a suspicion that the condition of homogeneity is not met (see paragraph 2.4. above), cores shall be taken from more locations within the test area.

The residual voids content has to be determined for each core, then the average value from all cores shall be calculated and compared with the requirement of paragraph 2.1. of this annex. In addition, no single core shall have a voids value, which is higher than 10 per cent.

The test surface constructor is reminded of the problem, which may arise when the test area is heated by pipes or electrical wires and cores shall be taken from this area. Such installations shall be carefully planned with respect to future core drilling locations. It is recommended to leave a few locations of size approximately 200 mm x 300 mm where there are no wires/pipes or where the latter are located deep enough in order not to be damaged by cores taken from the surface layer.

4.2. Sound absorption coefficient

The sound absorption coefficient (normal incidence) shall be measured by the impedance tube method using the procedure specified in ISO 10534-1:1996 or ISO 10534-2:1998.

Regarding test specimens, the same requirements shall be followed as regarding the residual voids content (see paragraph 4.1. above). The sound absorption shall be measured in the range between 400 Hz and 800 Hz and in the range between 800 Hz and 1,600 Hz (at least at the centre frequencies of third octave bands) and the maximum values shall be identified for both of these frequency ranges. Then these values, for all test scores, shall be averaged to constitute the final result.

4.3. Volumetric macro-texture measurement

For the purpose of this standard, texture depth measurements shall be made on at least 10 positions evenly spaced along the wheel tracks of the test strip and the average value taken to compare with the specified minimum texture depth. See Standard ISO 10844:2014 for description of the procedure.

5. Stability in time and maintenance

5.1. Age influence

In common with any other surfaces, it is expected that the tyre rolling sound level measured on the test surface may increase slightly during the first 6-12 months after construction.

The surface will achieve its required characteristics not earlier than four weeks after construction. The influence of age on the noise from trucks is generally less than that from cars.

The stability over time is determined mainly by the polishing and compaction by vehicles driving on the surface. It shall be periodically checked as stated in paragraph 2.5. above.

5.2. Maintenance of the surface

Loose debris or dust, which could significantly reduce the effective texture depth shall be removed from the surface. In countries with winter climates, salt is sometimes used for de-icing. Salt may alter the surface temporarily or even permanently in such a way as to increase noise and is therefore not recommended.

- 5.3. Repaving the test area
- If it is necessary to repave the test track, it is usually unnecessary to repave more than the test strip (of 3 m width in Figure 1) where vehicles are driving, provided the test area outside the strip met the requirement of residual voids content or sound absorption when it was measured.
6. Documentation of the test surface and of tests performed on it
- 6.1. Documentation of the test surface
- The following data shall be given in a document describing the test surface:
- 6.1.1. The location of the test track;
- 6.1.2. Type of binder, binder hardness, type of aggregate, maximum theoretical density of the concrete (DR), thickness of the wearing course and grading curve determined from cores from the test track;
- 6.1.3. Method of compaction (e.g. type of roller, roller mass, number of passes);
- 6.1.4. Temperature of the mix, temperature of the ambient air and wind speed during laying of the surface;
- 6.1.5. Date when the surface was laid and contractor;
- 6.1.6. All or at least the latest test result, including:
- 6.1.6.1. The residual voids content of each core;
- 6.1.6.2. The locations in the test area from where the cores for voids measurements have been taken;
- 6.1.6.3. The sound absorption coefficient of each core (if measured). Specify the results both for each core and each frequency range as well as the overall average;
- 6.1.6.4. The locations in the test area from where the cores for absorption measurement have been taken;
- 6.1.6.5. Texture depth, including the number of tests and standard deviation;
- 6.1.6.6. The institution responsible for tests according to paragraphs 6.1.6.1. and 6.1.6.2. above and the type of equipment used;
- 6.1.6.7. Date of the test(s) and date when the cores were taken from the test track.
- 6.2. Documentation of vehicle noise tests conducted on the surface
- In the document describing the vehicle noise test(s) it shall be stated whether all the requirements of this standard were fulfilled or not. Reference shall be given to a document according to paragraph 6.1. above describing the results which verify this.

## Annex 5

### Test procedures for measuring wet grip

#### (A) - C1 category tyres

##### 1. Reference standards

The following documents listed apply.

- 1.1. ASTM E 303-93 (Reapproved 2008), Standard Test Method for Measuring Surface Frictional Properties Using the British Pendulum Tester.
- 1.2. ASTM E 501-08, Standard Specification for Standard Rib Tire for Pavement Skid-Resistance Tests.
- 1.3. ASTM E 965-96 (Reapproved 2006), Standard Test Method for Measuring Pavement Macrottexture Depth Using a Volumetric Technique.
- 1.4. ASTM E 1136-93 (Reapproved 2003), Standard Specification for a Radial Standard Reference Test Tire P195/75R14.
- 1.5. ASTM F 2493-08, Standard Specification for a Radial Standard Reference Test Tire P225/60R16.

##### 2. Definitions

For the purposes of testing wet grip of C1 tyres:

- 2.1. "*Test run*" means a single pass of a loaded tyre over a given test track surface.
- 2.2. "*Test tyre(s)*" means a candidate tyre, a reference tyre or a control tyre or tyre set that is used in a test run.
- 2.3. "*Candidate tyre(s) (T)*" means a tyre or a tyre set that is tested for the purpose of calculating its wet grip index.
- 2.4. "*Reference tyre(s) (R)*" means a tyre or a tyre set that has the characteristics indicated in the ASTM F 2493-08 and referred to as the Standard Reference Test Tyre.
- 2.5. "*Control tyre(s) (C)*" means an intermediate tyre or a set of intermediate tyres which is used when the candidate tyre and the reference tyre cannot be directly compared on the same vehicle.
- 2.6. "*Braking force of a tyre*" means the longitudinal force, expressed in newton, resulting from braking torque application.
- 2.7. "*Braking Force Coefficient of a tyre (BFC)*" means the ratio of the braking force to the vertical load.
- 2.8. "*Peak braking force coefficient of a tyre*" means the maximum value of a tyre braking force coefficient that occurs prior to wheel lockup as the braking torque is progressively increased.

- 2.9. "Lockup of a wheel" means the condition of a wheel in which its rotational velocity about the wheel spin axis is zero and it is prevented from rotating in the presence of applied wheel torque.
- 2.10. "Vertical load" means the load in newton imposed on the tyre perpendicular to the road surface.
- 2.11. "Tyre test vehicle" means a dedicated special purpose vehicle which has instruments to measure the vertical and the longitudinal forces on one test tyre during braking.
- 2.12. "SRTT14" means the ASTM E 1136-93 (Reapproved 2003), Standard Specification for a Radial Standard Reference Test Tire P195/75R14.
- 2.13. "SRTT16" means the ASTM F 2493-08, Standard Specification for a Radial Standard Reference Test Tire P225/60R16.
3. General test conditions
- 3.1. Track characteristics
- The test track shall have the following characteristics:
- 3.1.1. The surface shall have a dense asphalt surface with a uniform gradient of not more than 2 per cent and shall not deviate more than 6 mm when tested with a 3 m straight edge.
- 3.1.2. The surface shall have a pavement of uniform age, composition, and wear. The test surface shall be free of loose material and foreign deposits.
- 3.1.3. The maximum chipping size shall be 10 mm (tolerances permitted from 8 mm to 13 mm).
- 3.1.4. The texture depth as measured by a sand patch shall be  $0.7 \pm 0.3$  mm. It shall be measured in accordance with ASTM E 965-96 (Reapproved 2006).
- 3.1.5. The wetted frictional properties of the surface shall be measured with either method (a) or (b) in paragraph 3.2.
- 3.2. Methods to measure the wetted frictional properties of the surface
- 3.2.1. British Pendulum Number (BPN) method (a)
- The British Pendulum Number method shall be as defined in ASTM E 303-93 (Reapproved in 2008).
- Pad rubber component formulation and physical properties shall be as specified in ASTM E 501-08.
- The averaged British Pendulum Number (BPN) shall be between 42 and 60 BPN after temperature correction as follows.
- BPN shall be corrected by the wetted road surface temperature. Unless temperature correction recommendations are indicated by the British pendulum manufacturer, the following formula is used:
- BPN = BPN (measured value) + temperature correction
- Temperature correction =  $-0.0018 t^2 + 0.34 t - 6.1$
- Where t is the wetted road surface temperature in degrees Celsius.



Effects of slider pad wear: the pad shall be removed for maximum wear when the wear on the striking edge of the slider reaches 3.2 mm in the plane of the slider or 1.6 mm vertical to it in accordance with paragraph 5.2.2. and Figure 3 of ASTM E 303-93 (Reapproved 2008).

For the purpose of checking track surface BPN consistency for the measurement of wet grip on an instrumented passenger car: the BPN values of the test track should not vary over the entire stopping distance so as to decrease the dispersion of test results. The wetted frictional properties of the surface shall be measured five times at each point of the BPN measurement every 10 meters and the coefficient of variation of the averaged BPN shall not exceed 10 per cent.

3.2.2. ASTM E 1136 Standard Reference Test Tyre method (b)

By derogation with paragraph 2.4. above, this method uses the reference tyre that has the characteristics indicated in the ASTM E 1136-93 (Reapproved 2003) and referred to as SRTT14.

The average peak braking force coefficient ( $\mu_{\text{peak,ave}}$ ) of the SRTT14 shall be  $0.7 \pm 0.1$  at 65 km/h.

The average peak braking force coefficient ( $\mu_{\text{peak,ave}}$ ) of the SRTT14 shall be corrected for the wetted road surface temperature as follows:

Peak braking force coefficient ( $\mu_{\text{peak,ave}}$ ) = peak braking force coefficient (measured) + temperature correction

Temperature correction =  $0.0035 \times (t - 20)$

Where t is the wetted road surface temperature in degrees Celsius.

3.3. Atmospheric conditions

The wind conditions shall not interfere with wetting of the surface (wind-shields are allowed).

Both the wetted surface temperature and the ambient temperature shall be between 2 °C and 20 °C for snow tyres and 5 °C and 35 °C for normal tyres.

The wetted surface temperature shall not vary during the test by more than 10 °C.

The ambient temperature must remain close to the wetted surface temperature; the difference between the ambient and the wetted surface temperatures must be less than 10 °C.

4. Testing methods for measuring wet grip

For the calculation of the wet grip index (G) of a candidate tyre, the wet grip braking performance of the candidate tyre is compared to the wet grip braking performance of the reference tyre on a vehicle travelling straight ahead on a wet, paved surface. It is measured with one of the following methods:

- (a) Vehicle method consisting of testing a set of tyres mounted on an instrumented passenger car;
- (b) Testing method using a trailer towed by a vehicle or a tyre test vehicle, equipped with the test tyre(s).

- 4.1. Testing method (a) using an instrumented passenger car
- 4.1.1. Principle
- The testing method covers a procedure for measuring the deceleration performance of C1 tyres during braking, using an instrumented passenger car equipped with an Antilock Braking System (ABS), where "instrumented passenger car" means a passenger car that is fitted with the measuring equipment listed in paragraph 4.1.2.2. below for the purpose of this testing method. Starting with a defined initial speed, the brakes are applied hard enough on four wheels at the same time to activate the ABS. The average deceleration is calculated between two pre-defined speeds.
- 4.1.2. Equipment
- 4.1.2.1. Vehicle
- Permitted modifications on the passenger car are as follows:
- (a) Those allowing the number of tyre sizes that can be mounted on the vehicle to be increased;
  - (b) Those permitting automatic activation of the braking device to be installed;
  - (c) Any other modification of the braking system is prohibited.
- 4.1.2.2. Measuring equipment
- The vehicle shall be fitted with a sensor suitable for measuring speed on a wet surface and distance covered between two speeds.
- To measure vehicle speed, a fifth wheel or non-contact speed-measuring system shall be used.
- 4.1.3. Conditioning of the test track and wetting condition
- The test track surface shall be watered at least half an hour prior to testing in order to equalize the surface temperature and water temperature. External watering should be supplied continuously throughout testing. For the whole testing area, the water depth shall be  $1.0 \pm 0.5$  mm, measured from the peak of the pavement.
- The test track should then be conditioned by conducting at least ten test runs with tyres not involved in the test programme at 90 km/h.
- 4.1.4. Tyres and rims
- 4.1.4.1. Tyre preparation and break-in
- The test tyres shall be trimmed to remove all protuberances on the tread surface caused by mould air vents or flashes at mould junctions.
- Fit the test tyres on rims specified by a recognized tyre and rim standards organization as listed in Appendix 4 to Annex 6 to this Regulation.
- 4.1.4.2. Tyre load
- The static load on each axle tyre shall lie between 60 per cent and 90 per cent of the tested tyre load capacity. Tyre loads on the same axle should not differ by more than 10 per cent.

- 4.1.4.3. Tyre inflation pressure  
On the front and rear axles, the inflation pressures shall be 220 kPa (for standard- and extra-load tyres). The tyre pressure should be checked just prior to testing at ambient temperature and adjusted if required.
- 4.1.5. Procedure
- 4.1.5.1. Test run  
The following test procedure applies for each test run.
- 4.1.5.1.1. The passenger car is driven in a straight line up to  $85 \pm 2$  km/h.
- 4.1.5.1.2. Once the passenger car has reached  $85 \pm 2$  km/h, the brakes are always activated at the same place on the test track referred to as "braking starting point", with a longitudinal tolerance of 5 m and a transverse tolerance of 0.5 m.
- 4.1.5.1.3. The brakes are activated either automatically or manually.
- 4.1.5.1.3.1. The automatic activation of the brakes is performed by means of a detection system made of two parts, one indexed to the test track and one on board the passenger car.
- 4.1.5.1.3.2. The manual activation of the brakes depends on the type of transmission as follows. In both cases, a minimum of 600 N pedal efforts is required.  
  
For manual transmission, the driver should release the clutch and depress the brake pedal sharply, holding it down as long as necessary to perform the measurement.  
  
For automatic transmission, the driver should select neutral gear and then depress the brake pedal sharply, holding it down as long as necessary to perform the measurement.
- 4.1.5.1.4. The average deceleration is calculated between 80 km/h and 20 km/h.  
  
If any of the specifications listed above (including speed tolerance, longitudinal and transverse tolerance for the braking starting point, and braking time) are not met when a test run is made, the measurement is discarded and a new test run is made.
- 4.1.5.2. Test cycle  
A number of test runs are made in order to measure the wet grip index of a set of candidate tyres (T) according to the following procedure, whereby each test run shall be made in the same direction and up to three different sets of candidate tyres may be measured within the same test cycle:
- 4.1.5.2.1. First, the set of reference tyres are mounted on the instrumented passenger car.
- 4.1.5.2.2. After at least three valid measurements have been made in accordance with paragraph 4.1.5.1. above, the set of reference tyres is replaced by a set of candidate tyres.
- 4.1.5.2.3. After six valid measurements of the candidate tyres are performed, two more sets of candidate tyres may be measured.
- 4.1.5.2.4. The test cycle is closed by three more valid measurements of the same set of reference tyres as at the beginning of the test cycle.

Examples:

- (a) The run order for a test cycle of three sets of candidate tyres (T1 to T3) plus a set of reference tyres (R) would be the following:

R-T1-T2-T3-R

- (b) The run order for a test cycle of five sets of candidate tyres (T1 to T5) plus a set of reference tyres (R) would be the following:

R-T1-T2-T3-R-T4-T5-R

4.1.6. Processing of measurement results

4.1.6.1. Calculation of the Average Deceleration (AD)

The Average Deceleration (AD) is calculated for each valid test run in  $m/s^2$  as follows:

$$AD = \left| \frac{S_f^2 - S_i^2}{2d} \right|$$

Where:

$S_f$  is the final speed in m/s;  $S_f = 20 \text{ km/h} = 5.556 \text{ m/s}$

$S_i$  is the initial speed in m/s;  $S_i = 80 \text{ km/h} = 22.222 \text{ m/s}$

$d$  is the distance covered between  $S_i$  and  $S_f$  in meter.

4.1.6.2. Validation of results

The AD coefficient of variation is calculated as follows:

(Standard deviation / Average) x 100.

For the reference tyres (R): If the AD coefficient of variation of any two consecutive groups of three tests runs of the reference tyre set is higher than 3 per cent, all data should be discarded and the test repeated for all test tyres (the candidate tyres and the reference tyres).

For the candidate tyres (T): The AD coefficients of variation are calculated for each candidate tyre set. If one coefficient of variation is higher than 3 per cent, the data should be discarded and the test repeated for that candidate tyre set.

4.1.6.3. Calculation of adjusted average deceleration (Ra)

The Average Deceleration (AD) of the reference tyre set used for the calculation of its braking force coefficient is adjusted according to the positioning of each candidate tyre set in a given test cycle.

This adjusted AD of the reference tyre (Ra) is calculated in  $m/s^2$  in accordance with Table 1 where  $R_1$  is the average of the AD values in the first test of the reference tyre set (R) and  $R_2$  is the average of the AD values in the second test of the same reference tyre set (R).

Table 1

<i>Number of sets of candidate tyres within one test cycle</i>	<i>Set of candidate tyres</i>	<i>Ra</i>
1 (R <sub>1</sub> -T1-R <sub>2</sub> )	T1	Ra = 1/2 (R <sub>1</sub> + R <sub>2</sub> )
2 (R <sub>1</sub> -T1-T2-R <sub>2</sub> )	T1	Ra = 2/3 R <sub>1</sub> + 1/3 R <sub>2</sub>
	T2	Ra = 1/3 R <sub>1</sub> + 2/3 R <sub>2</sub>
3 (R <sub>1</sub> -T1-T2-T3-R <sub>2</sub> )	T1	Ra = 3/4 R <sub>1</sub> + 1/4 R <sub>2</sub>
	T2	Ra = 1/2 (R <sub>1</sub> + R <sub>2</sub> )
	T3	Ra = 1/4 R <sub>1</sub> + 3/4 R <sub>2</sub>

4.1.6.4. Calculation of the Braking Force Coefficient (BFC)

The Braking Force Coefficient (BFC) is calculated for a braking on the two axles according to Table 2 where Ta (a = 1, 2 or 3) is the average of the AD values for each candidate tyre (T) set that is part of a test cycle.

Table 2

<i>Test Tyre</i>	<i>Braking force coefficient</i>
Reference tyre	BFC(R) =   Ra/g
Candidate tyre	BFC(T) =   Ta/g

g is the acceleration due to gravity, g = 9.81 m/s<sup>2</sup>

4.1.6.5. Calculation of the wet grip index of the candidate tyre

The wet grip index of the candidate tyre G(T) is calculated as follows:

$$G(T) = \left[ \frac{BFC(T)}{BFC(R)} \times 125 + a \times (t - t_0) + b \times \left( \frac{BFC(R)}{BFC(R_0)} - 1,0 \right) \right] \times 10^{-2}$$

Where:

t is the measured wet surface temperature in degree Celsius when the candidate tyre (T) is tested

t<sub>0</sub> is the wet surface reference temperature condition, t<sub>0</sub> = 20 °C for normal tyres and t<sub>0</sub> = 10 °C for snow tyres

BFC(R<sub>0</sub>) is the braking force coefficient for the reference tyre in the reference conditions, BFC(R<sub>0</sub>) = 0.68

a = -0.4232 and b = -8.297 for normal tyres, a = 0.7721 and b = 31.18 for snow tyres [a is expressed as (1/°C)]

4.1.7. Wet grip performance comparison between a candidate tyre and a reference tyre using a control tyre

4.1.7.1. General

Where the candidate tyre size is significantly different from that of the reference tyre, a direct comparison on the same instrumented passenger car may not be possible. This testing method uses an intermediate tyre, hereinafter called the control tyre as defined in paragraph 2.5. above.

4.1.7.2. Principle of the approach

The principle is the use of a control tyre set and two different instrumented passenger cars for the test cycle of a candidate tyre set in comparison with a reference tyre set.

One instrumented passenger car is fitted with the reference tyre set followed by the control tyre set, the other with the control tyre set followed by the candidate tyre set.

The specifications listed in paragraphs 4.1.2. to 4.1.4. above apply.

The first test cycle is a comparison between the control tyre set and the reference tyre set.

The second test cycle is a comparison between the candidate tyre set and the control tyre set. It is done on the same test track and during the same day as the first test cycle. The wetted surface temperature shall be within  $\pm 5$  °C of the temperature of the first test cycle. The same control tyre set shall be used for the first and the second test cycles.

The wet grip index of the candidate tyre  $G(T)$  is calculated as follows:

$$G(T) = G_1 \times G_2$$

Where:

$G_1$  is the relative wet grip index of the control tyre (C) compared to the reference tyre (R) calculated as follows:

$$G_1 = \left[ \frac{\text{BFC}(C)}{\text{BFC}(R)} \times 125 + a \times (t - t_0) + b \times \left( \frac{\text{BFC}(R)}{\text{BFC}(R_0)} - 1.0 \right) \right] \times 10^{-2}$$

$G_2$  is the relative wet grip index of the candidate tyre (T) compared to the control tyre (C) calculated as follows:

$$G_2 = \frac{\text{BFC}(T)}{\text{BFC}(C)}$$

4.1.7.3. Storage and preservation

It is necessary that all the tyres of a control tyre set have been stored in the same conditions. As soon as the control tyre set has been tested in comparison with the reference tyre, the specific storage conditions defined in ASTM E 1136-93 (Reapproved 2003) shall be applied.

4.1.7.4. Replacement of reference tyres and control tyres

When irregular wear or damage results from tests, or when wear influences the test results, the use of the tyre shall be discontinued.

4.2. Testing method (b) using a trailer towed by a vehicle or a tyre test vehicle

4.2.1. Principle

The measurements are conducted on test tyres mounted on a trailer towed by a vehicle (hereafter referred to as tow vehicle) or on a tyre test vehicle. The brake in the test position is applied firmly until sufficient braking torque is generated to produce the maximum braking force that will occur prior to wheel lockup at a test speed of 65 km/h.

4.2.2. Equipment

4.2.2.1. Tow vehicle and trailer or tyre test vehicle

The tow vehicle or the tyre test vehicle shall have the capability of maintaining the specified speed of  $65 \pm 2$  km/h even under the maximum braking forces.

The trailer or the tyre test vehicle shall be equipped with one place where the tyre can be fitted for measurement purposes hereafter called 'test position' and the following accessories:

- (a) Equipment to activate brakes in the test position;
- (b) A water tank to store sufficient water to supply the road surface wetting system, unless external watering is used;
- (c) Recording equipment to record signals from transducers installed at the test position and to monitor water application rate if the self-watering option is used.

The maximum variation of toe-settings and camber angle for the test position shall be within  $\pm 0.5^\circ$  with maximum vertical load. Suspension arms and bushings shall have sufficient rigidity necessary to minimize free play and ensure compliance under application of maximum braking forces. The suspension system shall provide adequate load-carrying capacity and be of such a design as to isolate suspension resonance.

The test position shall be equipped with a typical or special automotive brake system which can apply sufficient braking torque to produce the maximum value of braking test wheel longitudinal force at the conditions specified.

The brake application system shall be able to control the time interval between initial brake application and peak longitudinal force as specified in paragraph 4.2.7.1. below.

The trailer or the tyre test vehicle shall be designed to accommodate the range of candidate tyre sizes to be tested.

The trailer or the tyre test vehicle shall have provisions for adjustment of vertical load as specified in paragraph 4.2.5.2. below

4.2.2.2. Measuring equipment

The test wheel position on the trailer or the tyre test vehicle shall be equipped with a rotational wheel velocity measuring system and with transducers to measure the braking force and vertical load at the test wheel.

General requirements for measurement system: The instrumentation system shall conform to the following overall requirements at ambient temperatures between 0 °C and 45 °C:

- (a) Overall system accuracy, force:  $\pm 1.5$  per cent of the full scale of the vertical load or braking force;
- (b) Overall system accuracy, speed:  $\pm 1.5$  per cent of speed or  $\pm 1.0$  km/h, whichever is greater.

Vehicle speed: To measure vehicle speed, a fifth wheel or non-contact precision speed-measuring system should be used.

Braking forces: The braking force-measuring transducers shall measure longitudinal force generated at the tyre-road interface as a result of brake application within a range from 0 per cent to at least 125 per cent of the applied vertical load. The transducer design and location shall minimize inertial effects and vibration-induced mechanical resonance.

Vertical load: The vertical load-measuring transducer shall measure the vertical load at the test position during brake application. The transducer shall have the same specifications as described previously.

Signal conditioning and recording system: All signal conditioning and recording equipment shall provide linear output with necessary gain and data reading resolution to meet the specified previous requirements. In addition, the following requirements apply:

- (a) The minimum frequency response shall be flat from 0 Hz to 50 Hz (100 Hz) within  $\pm 1$  per cent full scale;
- (b) The signal-to-noise ratio shall be at least 20/1;
- (c) The gain shall be sufficient to permit full-scale display for full-scale input signal level;
- (d) The input impedance shall be at least ten times larger than the output impedance of the signal source;
- (e) The equipment shall be insensitive to vibrations, acceleration, and changes in ambient temperature.

4.2.3. Conditioning of the test track

The test track should be conditioned by conducting at least ten test runs with tyres not involved in the test program at  $65 \pm 2$  km/h.



4.2.4. Wetting conditions

The tow vehicle and trailer or the tyre test vehicle may be optionally equipped with a pavement-wetting system, less the storage tank, which, in the case of the trailer, is mounted on the tow vehicle. The water being applied to the pavement ahead of the test tyres shall be supplied by a nozzle suitably designed to ensure that the water layer encountered by the test tyre has a uniform cross section at the test speed with a minimum splash and overspray.

The nozzle configuration and position shall ensure that the water jets are directed towards the test tyre and pointed towards the pavement at an angle of 20° to 30°.

The water shall strike the pavement 250 mm to 450 mm ahead of the centre of tyre contact. The nozzle shall be located 25 mm above the pavement or at the minimum height required to clear obstacles which the tester is expected to encounter, but in no case more than 100 mm above the pavement.

The water layer shall be at least 25 mm wider than the test tyre tread and applied so the tyre is centrally located between the edges. Water delivery rate shall ensure a water depth of  $1.0 \pm 0.5$  mm and shall be consistent throughout the test to within  $\pm 10$  per cent. The volume of water per unit of wetted width shall be directly proportional to the test speed. The quantity of water applied at 65 km/h shall be 18 l/s per meter of width of wetted surface in case of a water depth of 1.0 mm.

4.2.5. Tyres and rims

4.2.5.1. Tyre preparation and break-in

The test tyres shall be trimmed to remove all protuberances on the tread surface caused by mould air vents or flashes at mould junctions.

The test tyre shall be mounted on the test rim declared by the tyre manufacturer.

A proper bead seat should be achieved by the use of a suitable lubricant. Excessive use of lubricant should be avoided to prevent slipping of the tyre on the wheel rim.

The test tyres/rim assemblies shall be stored in a location for a minimum of two hours such that they all have the same ambient temperature prior to testing. They should be shielded from the sun to avoid excessive heating by solar radiation.

For tyre break-in, two braking runs shall be performed under the load, pressure and speed as specified in paragraphs 4.2.5.2, 4.2.5.3 and 4.2.7.1 respectively.

4.2.5.2. Tyre load

The test load on the test tyre is  $75 \pm 5$  per cent of the tyre load capacity.

4.2.5.3. Tyre inflation pressure

The test tyre cold inflation pressure shall be 180 kPa for standard-load tyres. For extra-load tyres, the cold inflation pressure shall be 220 kPa.

The tyre pressure should be checked just prior to testing at ambient temperature and adjusted if required.

- 4.2.6. Preparation of the tow vehicle and trailer or the tyre test vehicle
  - 4.2.6.1. Trailer

For one axle trailers, the hitch height and transverse position shall be adjusted once the test tyre has been loaded to the specified test load in order to avoid any disturbance of the measuring results. The longitudinal distance from the centre line of the articulation point of the coupling to the transverse centre line of the axle of the trailer shall be at least ten times the "hitch height" or the "coupling (hitch) height".
  - 4.2.6.2. Instrumentation and equipment

Install the fifth wheel, when used, in accordance with the manufacturer's specifications and locate it as near as possible to the mid-track position of the tow trailer or the tyre test vehicle.
- 4.2.7. Procedure
  - 4.2.7.1. Test run

The following procedure applies for each test run:

    - 4.2.7.1.1. The tow vehicle or the tyre test vehicle is driven onto the test track in a straight line at the specified test speed  $65 \pm 2$  km/h.
    - 4.2.7.1.2. The recording system is launched.
    - 4.2.7.1.3. Water is delivered to the pavement ahead of the test tyre approximately 0.5 s prior to brake application (for internal watering system).
    - 4.2.7.1.4. The trailer brakes are activated within 2 meters of a measurement point of the wetted frictional properties of the surface and sand depth in accordance with paragraphs 3.1.4. and 3.1.5. above. The rate of braking application shall be such that the time interval between initial application of force and peak longitudinal force is in the range 0.2 s to 0.5 s.
    - 4.2.7.1.5. The recording system is stopped.
  - 4.2.7.2. Test cycle

A number of test runs are made in order to measure the wet grip index of the candidate tyre (T) according to the following procedure, whereby each test run shall be made from the same spot on the test track and in the same direction. Up to three candidate tyres may be measured within the same test cycle, provided that the tests are completed within one day.

    - 4.2.7.2.1. First, the reference tyre is tested.
    - 4.2.7.2.2. After at least six valid measurements are performed in accordance with paragraph 4.2.7.1. above, the reference tyre is replaced by the candidate tyre.
    - 4.2.7.2.3. After six valid measurements of the candidate tyre are performed, two more candidate tyres may be measured.
    - 4.2.7.2.4. The test cycle is closed by six more valid measurements of the same reference tyre as at the beginning of the test cycle.

Examples:

- (a) The run order for a test cycle of three candidate tyres (T1 to T3) plus the reference tyre (R) would be the following:

R-T1-T2-T3-R

- (b) The run order for a test cycle of five candidate tyres (T1 to T5) plus the reference tyre R would be the following:

R-T1-T2-T3-R-T4-T5-R

4.2.8. Processing of measurement results

4.2.8.1. Calculation of the peak braking force coefficient

The tyre peak braking force coefficient ( $\mu_{\text{peak}}$ ) is the highest value of  $\mu(t)$  before lockup occurs calculated as follows for each test run. Analogue signals should be filtered to remove noise. Digitally recorded signals must be filtered using a moving average technique.

$$\mu(t) = \frac{|fh(t)|}{fv(t)}$$

Where:

$\mu(t)$  is the dynamic tyre braking force coefficient in real time;

$fh(t)$  is the dynamic braking force in real time, in N;

$fv(t)$  is the dynamic vertical load in real time, in N.

4.2.8.2. Validation of results

The  $\mu_{\text{peak}}$  coefficient of variation is calculated as follows:

(Standard deviation / Average) x 100

For the reference tyre (R): If the coefficient of variation of the peak braking force coefficient ( $\mu_{\text{peak}}$ ) of the reference tyre is higher than 5 per cent, all data should be discarded and the test repeated for all test tyres (the candidate tyre(s) and the reference tyre).

For the candidate tyre(s) (T): The coefficient of variation of the peak braking force coefficient ( $\mu_{\text{peak}}$ ) is calculated for each candidate tyre. If one coefficient of variation is higher than 5 per cent, the data should be discarded and the test repeated for this candidate tyre.

4.2.8.3. Calculation of the adjusted average peak braking force coefficient

The average peak braking force coefficient of the reference tyre used for the calculation of its braking force coefficient is adjusted according to the positioning of each candidate tyre in a given test cycle.

This adjusted average peak braking force coefficient of the reference tyre ( $R_a$ ) is calculated in accordance with Table 3 where  $R_1$  is the average peak tyre braking coefficient in the first test of the reference tyre (R) and  $R_2$  is the average peak tyre braking coefficient in the second test of the same reference tyre (R).

Table 3

Number of candidate tyre(s) within one test cycle	Candidate tyre	Ra
1 (R1-T1-R2)	T1	Ra = 1/2 (R <sub>1</sub> + R <sub>2</sub> )
2 (R1-T1-T2-R2)	T1	Ra = 2/3 R <sub>1</sub> + 1/3 R <sub>2</sub>
	T2	Ra = 1/3 R <sub>1</sub> + 2/3 R <sub>2</sub>
3 (R1-T1-T2-T3-R2)	T1	Ra = 3/4 R <sub>1</sub> + 1/4 R <sub>2</sub>
	T2	Ra = 1/2 (R <sub>1</sub> + R <sub>2</sub> )
	T3	Ra = 1/4 R <sub>1</sub> + 3/4 R <sub>2</sub>

4.2.8.4 Calculation of the average peak braking coefficient ( $\mu_{\text{peak,ave}}$ )

The average value of the peak braking coefficients ( $\mu_{\text{peak,ave}}$ ) is calculated according to Table 4 whereby Ta (a = 1, 2 or 3) is the average of the peak braking force coefficients measured for one candidate tyre within one test cycle.

Table 4

Test tyre	$\mu_{\text{peak,ave}}$
Reference tyre	$\mu_{\text{peak,ave}}(\text{R}) = \text{Ra}$ as per Table 3
Candidate tyre	$\mu_{\text{peak,ave}}(\text{T}) = \text{Ta}$

4.2.8.5. Calculation of the wet grip index of the candidate tyre

The wet grip index of the candidate tyre (G(T)) is calculated as follows:

$$G(\text{T}) = \left[ \frac{\mu_{\text{peak,ave}}(\text{T})}{\mu_{\text{peak,ave}}(\text{R})} \times 125 + a \times (t - t_0) + b \times \left( \frac{\mu_{\text{peak,ave}}(\text{R})}{\mu_{\text{peak,ave}}(\text{R}_0)} - 1.0 \right) \right] \times 10^{-2}$$

Where:

t is the measured wet surface temperature in degree Celsius when the candidate tyre (T) is tested

t<sub>0</sub> is the wet surface reference temperature condition

t<sub>0</sub> = 20 °C for normal tyres t<sub>0</sub>=10°C for snow tyres

$\mu_{\text{peak,ave}}(\text{R}_0) = 0.85$  is the peak braking force coefficient for the reference tyre in the reference conditions

a = -0.4232 and b = -8.297 for normal tyres, a = 0.7721 and b = 31.18 for snow tyres [a is expressed as (1/°C)].

(B) – C2 and C3 category tyres

1. General test conditions

1.1. Track characteristics

The surface shall be a dense asphalt surface with a uniform gradient of not more than two per cent and shall not deviate more than 6 mm when tested with a 3 m straight edge.

The test surface shall have a pavement of uniform age, composition, and wear. The test surface shall be free of loose material or foreign deposits.

The maximum chipping size shall be from 8 mm to 13 mm.

The sand depth measured as specified in EN13036-1:2001 and ASTM E 965-96 (reapproved 2006) shall be  $0.7 \pm 0.3$  mm.

The surface friction value for the wetted track shall be established by one or other of the following methods according to the discretion of the Contracting Party.

1.1.1. Standard Reference Test Tyre (SRTT) method

The average peak braking coefficient ( $\mu$  peak average) of the ASTM E1136 - 93 (reapproved 2003) reference tyre (Test method using a trailer or a tyre test vehicle as specified in clause 2.1) shall be  $0.7 \pm 0.1$  (at 65 km/h and 180 kPa). The measured values shall be corrected for the effects of temperature as follows:

$$pbfc = pbfc \text{ (measured)} + 0.0035 \cdot (t - 20)$$

Where "t" is the wetted track surface temperature in degrees Celsius.

The test shall be conducted using the lanes and length of the track to be used for the wet grip test.

For the trailer method, testing is run in such a way that braking occurs within 10 meters distance of where the surface was characterized.

1.1.2. British Pendulum Number (BPN) method

The averaged British Pendulum Number (BPN) British Pendulum Tester method as specified in ASTM E 303-93 (reapproved 2008) using the Pad as specified in ASTM E 501-08 shall be  $(50 \pm 10)$  BPN after temperature correction.

BPN shall be corrected by the wetted road surface temperature. Unless temperature correction recommendations are indicated by the British pendulum manufacturer the following formula can be used:

$$BPN = BPN \text{ (measured value)} - (0.0018 \cdot t^2) + 0.34 \cdot t - 6.1$$

Where: "t" is the wetted road surface temperature in degrees Celsius.

Effects of slider pad wear: the pad should be removed for maximum wear when the wear on the striking edge of the slider reaches 3.2 mm in the plane of the slider or 1.6 mm vertical to it.

Check the test track testing surface BPN consistency for the measurement of wet grip on a standard vehicle.

In the lanes of the track to be used during the wet grip tests, the BPN shall be measured at intervals of 10 m along the length of the lanes. The BPN shall be measured 5 times at each point and the coefficient of variation of the BPN averages shall not exceed 10 per cent.

1.1.3. The Type Approval Authority shall satisfy itself of the characteristics of the track on the basis of evidence produced in test reports.

1.2. The surface may be wetted from the track-side or by a wetting system incorporated into the test vehicle or the trailer.

If a track-side system is used, the test surface shall be wetted for at least half an hour prior to testing in order to equalize the surface temperature and water temperature. It is recommended that track-side wetting be continuously applied throughout testing.

The water depth shall be between 0.5 and 2.0 mm.

1.3. The wind conditions shall not interfere with wetting of the surface (wind-shields are permitted).

The ambient and the wetted surface temperature shall be between 5 °C and 35 °C and shall not vary during the test by more than 10 °C.

1.4. In order to cover the range of the tyre sizes fitting the commercial vehicles, three Standard Reference Testing Tyre (SRTT) sizes shall be used to measure the relative wet index:

- (a) SRTT 315/70R22.5 LI=154/150, ASTM F2870
- (b) SRTT 245/70R19.5 LI=136/134, ASTM F2871
- (c) SRTT 225/75 R 16 C LI=116/114, ASTM F2872

The three standard reference testing tyre sizes shall be used to measure the relative wet index as shown in the following table:

<i>For C3 tyres</i>	
Narrow family $S_{\text{Nominal}} < 285 \text{ mm}$	Wide family $S_{\text{Nominal}} \geq 285 \text{ mm}$
SRTT 245/70R19.5 LI=136/134	SRTT 315/70R22.5 LI=154/150
<i>For C2 tyres</i>	
SRTT 225/75 R 16 C LI=116/114	
$S_{\text{Nominal}} = \text{Tyre nominal section width}$	

2. Test procedure

The comparative wet grip performance shall be established using either:

- (a) A trailer or special purpose tyre evaluation vehicle; or
- (b) A standard production vehicle (M<sub>2</sub>, M<sub>3</sub>, N<sub>1</sub>, N<sub>2</sub> or N<sub>3</sub> category) as defined in the Consolidated Resolution on the Construction of Vehicles (R.E.3.) contained in ECE/TRANS/WP.29/78/Rev.4, para. 2.

2.1. Trailer or special purpose tyre evaluation vehicle procedure

2.1.1. The measurements are conducted on (a) tyre(s) mounted on a trailer towed by a vehicle or a tyre test vehicle.

The brake on the test position is applied firmly until sufficient braking torque results to produce maximum braking force that will occur prior to wheel lockup at a test speed of 50 km/h. The trailer, together with the towing vehicle, or the tyre evaluation vehicle shall comply with the following requirements:

- 2.1.1.1. Be capable of exceeding the upper limit for the test speed of 50 km/h and of maintaining the test speed requirement of  $(50 \pm 2)$  km/h even at the maximum level of application of braking forces;
- 2.1.1.2. Be equipped with an axle providing one test position having an hydraulic brake and actuation system that can be operated at the test position from the towing vehicle if applicable. The braking system shall be capable of providing sufficient braking torque to achieve the peak brake force coefficient over the range of tyre sizes and tyre loads to be tested;
- 2.1.1.3. Be capable of maintaining longitudinal alignment (toe) and camber of the test wheel and tyre assembly throughout the test within  $\pm 0.5^\circ$  of the static figures achieved at the test tyre loaded condition;
- 2.1.1.4. In the case a track wetting system is incorporated:

The system shall be able to deliver the water such that the tyre and track surface in front of the tyre are wetted before the start of braking and throughout the duration of the test. The apparatus may be optionally equipped with a pavement-wetting system, less the storage tank, which, in the case of the trailer, is mounted on the tow vehicle. The water being applied to the pavement ahead of the test tyres shall be supplied by a nozzle suitably designed to ensure that the water layer encountered by the test tyre has a uniform cross section at the test speed with a minimum splash and overspray.

The nozzle configuration and position shall ensure that the water jets shall be directed toward the test tyre and pointed toward the pavement at an angle of 15 to 30°. The water shall strike the pavement 0.25 to 0.5 m ahead of the centre of tyre contact. The nozzle shall be located 100 mm above the pavement or the minimum height required to clear obstacles which the tester is expected to encounter, but in no case more than 200 mm above the pavement. The water layer shall be at least 25 mm wider than the test tyre tread and applied so the tyre is centrally located between the edges. The volume of water per unit of wetted width shall be directly proportional to the test speed. The quantity of water applied at 50 km/h shall be 14 l/s per meter of the width of the wetted surface. The nominal values of rate of water application shall be maintained within  $\pm 10$  per cent.

- 2.1.2. Test procedure

- 2.1.2.1. Fit the test tyres on rims specified by a recognized tyre and rim standards organization as listed in Appendix 4 to Annex 6 to this Regulation. Ensure proper bead seating by the use of a suitable lubricant. Excessive use of lubricant should be avoided to prevent slipping of the tyre on the wheel rim.

Check the test tyres for the specified inflation pressure at ambient temperature (cold), just prior to testing. For the purpose of this standard the testing tyre cold inflation pressure  $P_t$  shall be calculated as follows:

$$P_t = P_r \times \left( \frac{Q_t}{Q_r} \right)^{1.25}$$

Where:

$P_r$  = Inflation pressure marked on the sidewall. If  $P_r$  is not marked on the sidewall refer to the specified pressure in applicable tyre standards manuals corresponding to maximum load capacity for single applications

$Q_t$  = The static test load of the tyre

$Q_r$  = The maximum mass associated with the load capacity index of the tyre

- 2.1.2.2. For tyre break-in, two braking runs are performed. The tyre shall be conditioned for a minimum of two hours adjacent to the test track such that it is stabilized at the ambient temperature of the test track area. The tyre(s) shall not be exposed to direct sunshine during conditioning.
- 2.1.2.3. The load conditions for testing shall be  $75 \pm 5$  per cent of the value corresponding to the load index.
- 2.1.2.4. Shortly before testing, the track shall be conditioned by carrying out at least ten braking test runs at 50 km/h on the part of the track to be used for the performance test programme but using a tyre not involved in that programme;
- 2.1.2.5. Immediately prior to testing, the tyre inflation pressure shall be checked and reset, if necessary, to the values given in paragraph 2.1.2.1.
- 2.1.2.6. The test speed shall be at  $50 \pm 2$  km/h and shall be maintained between these limits throughout the test run.
- 2.1.2.7. The direction of the test shall be the same for each set of tests and shall be the same for the test tyre as that used for the SRTT with which its performance is to be compared.
- 2.1.2.8. Deliver water to the pavement ahead of the test tyre approximately 0.5 s prior to brake application (for internal watering system). The brakes of the test wheel assembly shall be applied such that peak braking force is achieved within 0.2 s and 1.0 s of brake application.
- 2.1.2.9. For new tyres, the first two braking runs are discarded for tyre break-in.
- 2.1.2.10. For the evaluation of the performance of any tyre compared with that of the SRTT, the braking test should be run at the same area on the test pad.
- 2.1.2.11. The order of testing shall be:

R1 - T - R2

Where:

R1 = the initial test of the SRTT,

R2 = the repeat test of the SRTT and

T = the test of the candidate tyre to be evaluated.

A maximum of three candidate tyres may be tested before repeating the SRTT test, for example:

R1 - T1 - T2 - T3 - R2



2.1.2.12. Calculate the peak braking force coefficient,  $\mu_{\text{peak}}$ , for each test using the following equation:

$$\mu(t) = \left| \frac{f_h(t)}{f_v(t)} \right| \quad (1)$$

Where:

$\mu(t)$  = dynamic tyre braking force coefficient in real time,

$f_h(t)$  = dynamic braking force in real time, N,

$f_v(t)$  = dynamic vertical load in real time, N

Using equation (1) for dynamic tyre braking force coefficient, calculate the peak tyre braking force coefficient,  $\mu_{\text{peak}}$ , by determining the highest value of  $\mu(t)$  before lockup occurs. Analogic signals should be filtered to remove noise. Digitally recorded signals may be filtered using a moving average technique.

Calculate the average values of peak-braking coefficient ( $\mu_{\text{peak, ave}}$ ) by averaging four or more valid repeated runs for each set of test and reference tyres for each test condition provided that the tests are completed within the same day.

2.1.2.13. Validation of results

For the reference tyre:

If the coefficient of variation of the peak braking coefficient, which is calculated by "standard deviation/average x 100" of the reference tyre is higher than five per cent, discard all data and repeat the test for this reference tyre.

For the candidate tyres:

The coefficients of variation (standard deviation/average x 100) are calculated for all the candidate tyres. If one coefficient of variation is greater than five per cent, discard the data for this candidate tyre and repeat the test.

If  $R_1$  is the average of the peak braking coefficient in the first test of the reference tyre,  $R_2$  is the average of the peak braking coefficient in the second test of the reference tyre, the following operations are performed, according to the following table:

<i>If the number of sets of candidate tyres between two successive runs of the reference tyre is:</i>	<i>and the set of candidate tyres to be qualified is:</i>	<i>then "Ra" is calculated by applying the following:</i>
1   $R_1 - T_1 - R_2$	T1	$R_a = 1/2 (R_1 + R_2)$
2   $R_1 - T_1 - T_2 - R_2$	T1 T2	$R_a = 2/3 R_1 + 1/3 R_2$ $R_a = 1/3 R_1 + 2/3 R_2$
3   $R_1 - T_1 - T_2 - T_3 - R_2$	T1 T2 T3	$R_a = 3/4 R_1 + 1/4 R_2$ $R_a = 1/2 (R_1 + R_2)$ $R_a = 1/4 R_1 + 3/4 R_2$

- 2.1.2.14. The wet grip index (G) shall be calculated as:  
Wet grip index (G) =  $\mu_{\text{peak,ave}}(T)/\mu_{\text{peak,ave}}(R)$   
It represents the relative Wet Grip Index for braking performance of the candidate tyre (T) compared to the reference tyre (R).
- 2.2. Standard vehicle procedure
- 2.2.1. The vehicle used shall have two axles and be equipped with an anti-lock braking system (e.g. standard production vehicle of M<sub>2</sub>, M<sub>3</sub>, N<sub>1</sub>, N<sub>2</sub> or N<sub>3</sub> category). The ABS shall continue to fulfil the utilisation of adhesion requirements defined in the Regulations as appropriate, and shall be comparable and constant throughout the tests with the different tyres mounted.
- 2.2.1.1. Measuring equipment  
The vehicle shall be fitted with a sensor suitable for measuring speed on a wet surface and distance covered between two speeds.  
To measure vehicle speed, a fifth wheel or non-contact speed-measuring system shall be used.  
The following tolerances shall be respected:
- (a) For the speed measurements:  $\pm 1$  per cent or  $\pm 0.5$  km/h whichever is greater;
  - (b) For the distance measurements:  $\pm 1 \times 10^{-1}$  m.
- A display of the measured speed or the difference between the measured speed and the reference speed for the test can be used inside the vehicle so that the driver can adjust the speed of the vehicle.  
A data acquisition system can be also used for storing the measurements.
- 2.2.2. Test procedure  
Starting with a defined initial speed, the brakes are applied hard enough on the two axles at the same time to activate the ABS system.
- 2.2.2.1. The Average Deceleration (AD) is calculated between two defined speeds, with an initial speed of 60 km/h and a final speed of 20 km/h.
- 2.2.2.2. Vehicle equipment  
The rear axle may be indifferently fitted with 2 or 4 tyres.  
For the reference tyre testing, both axles are fitted with reference tyres. (A total of 4 or 6 reference tyres depending on the choice above mentioned).  
For the candidate tyre testing, 3 fitting configurations are possible:
- (a) Configuration "Configuration 1": Candidate tyres on front and rear axles: it is the standard configuration that should be used every time it is possible.
  - (b) Configuration "Configuration 2": Candidate tyres on front axle and reference tyre or control tyre on rear axle: allowed in such cases where fitting the candidate tyre on the rear position is not possible.

- (c) Configuration "Configuration 3": Candidate tyres on rear axle and reference tyre or control tyre on front axle; permitted in such cases where fitting the candidate tyre on the front position is not possible.

2.2.2.3. Tyre inflation pressure

- (a) For a vertical load higher or equal to 75 per cent of the load capacity of the tyre, the test inflation pressure "P<sub>t</sub>" shall be calculated as follows:

$$P_t = P_r \cdot (Q_t/Q_r)^{1.25}$$

P<sub>r</sub> = Inflation pressure marked on the sidewall. If P<sub>r</sub> is not marked on the sidewall refer to the specified pressure in applicable tyre standards manuals corresponding to maximum load capacity for single applications

Q<sub>t</sub> = static test load of the tyre

Q<sub>r</sub> = maximum mass associated with the load capacity index of the tyre

- (b) For a vertical load lower than 75 per cent of the load capacity of the tyre, the test inflation pressure P<sub>t</sub> shall be calculated as follows:

$$P_t = P_r \cdot (0.75)^{1.25} = (0.7) \cdot P_r$$

P<sub>r</sub> = Inflation pressure marked on the sidewall.

If P<sub>r</sub> is not marked on the sidewall refer to the specified pressure in applicable tyre standard manuals corresponding to maximum load capacity for single applications.

Check the tyre pressure just prior to testing at ambient temperature.

2.2.2.4. Tyre load

The static load on each axle shall remain the same throughout the test procedure. The static load on each tyre shall lie between 60 per cent and 100 per cent of the candidate tyre's load capacity. This value shall not exceed 100 per cent of the load capacity of the reference tyre.

Tyre load on the same axle should not differ by more than 10 per cent.

The use of fitting as per Configurations 2 and 3 shall fulfil the following additional requirements:

Configuration 2: Front axle load > Rear axle load

The rear axle may be indifferently fitted with 2 or 4 tyres

Configuration 3: Rear axle load > Front axle load x 1.8

2.2.2.5. Tyre preparation and break-in

- 2.2.2.5.1. The test tyre shall be mounted on the test rim declared by the tyre manufacturer.

Ensure proper bead seating by the use of a suitable lubricant. Excessive use of lubricant should be avoided to prevent slipping of the tyre on the wheel rim.

- 2.2.2.5.2. Place the fitted test tyres in a location for a minimum of two hours such that they all have the same ambient temperature prior to testing, and shield them from the sun to avoid excessive heating by solar radiation. For tyre break-in, perform two braking runs.
- 2.2.2.5.3. Condition the pavement by conducting at least ten test runs with tyres not involved in the test programme at an initial speed higher or equal to 65 km/h (which is higher than the initial test speed to guarantee that a sufficient length of track is conditioned).
- 2.2.2.6. Procedure
- 2.2.2.6.1. First, mount the set of reference tyres on the vehicle.
- The vehicle accelerates in the starting zone up to  $65 \pm 2$  km/h.
- Activation of the brakes on the track is made always at the same place with a tolerance of 5 meters in longitudinal and 0.5 meters in transverse.
- 2.2.2.6.2. According to the type of transmission, two cases are possible:
- (a) Manual transmission
- As soon as the driver is in the measuring zone and having reached  $65 \pm 2$  km/h, the clutch is released and the brake pedal depressed sharply, holding it down as long as necessary to perform the measurement.
- (b) Automatic transmission
- As soon as the driver is in the measuring zone and having reached  $65 \pm 2$  km/h, select neutral gear and then the brake pedal is depressed sharply, holding it down as long as necessary to perform the measurement.
- Automatic activation of the brakes can be performed by means of a detection system made of two parts, one indexed to the track and one embarked on the vehicle. In that case braking is made more rigorously at the same portion of the track.
- If any of the above-mentioned conditions are not met when a measurement is made (speed tolerance, braking time, etc.), the measurement is discarded and a new measurement is made.
- 2.2.2.6.3. Test running order
- Examples:
- The run order for a test of 3 sets of candidate tyres (T1 to T3) plus a reference tyre R would be:
- R - T1 - T2 - T3 - R
- The run order for a test of 5 sets of tyres (T1 to T5) plus a reference tyre R would be:
- R - T1 - T2 - T3 - R - T4 - T5 - R
- 2.2.2.6.4. The direction of the test shall be the same for each set of tests and shall be the same for the candidate test tyre as that used for the SRTT with which its performance is to be compared.

- 2.2.2.6.5. For each test and for new tires, the first two braking measurements are discarded.
- 2.2.2.6.6. After at least 3 valid measurements have been made in the same direction, the reference tyres are replaced by a set of the candidate tyres (one of the 3 configurations presented in paragraph 2.2.2.2.) and at least 6 valid measurements shall be performed.
- 2.2.2.6.7. A maximum of three sets of candidate tyres can be tested before the reference tyre is re-tested.

2.2.2.7. Processing of measurement results

2.2.2.7.1. Calculation of the Average Deceleration (AD)

Each time the measurement is repeated, the average deceleration AD [ $\text{m}\cdot\text{s}^{-2}$ ] is calculated by:

$$AD = \left| \frac{S_f^2 - S_i^2}{2d} \right|$$

Where d [m] is the distance covered between the initial speed  $S_i$  [ $\text{m}\cdot\text{s}^{-1}$ ] and the final speed  $S_f$  [ $\text{m}\cdot\text{s}^{-1}$ ].

2.2.2.7.2. Validation of results

For the reference tyre:

If the coefficient of variation of "AD" of any two consecutive groups of 3 runs of the reference tyre is higher than 3 per cent, discard all data and repeat the test for all tyres (the candidate tyres and the reference tyre). The coefficient of variation is calculated by the following relation:

$$\frac{\text{standard deviation}}{\text{average}} \times 100$$

For the candidate tyres:

The coefficients of variation are calculated for all the candidate tyres.

$$\frac{\text{standard deviation}}{\text{average}} \times 100$$

If one coefficient of variation is greater than 3 per cent, discard the data for this candidate tyre and repeat the test.

2.2.2.7.3. Calculation of the "average AD"

If  $R_1$  is the average of the AD values in the first test of the reference tyre and  $R_2$  is the average of the AD values in the second test of the reference tyre, the following operations are performed, according to Table 5.

$R_a$  is the adjusted average AD of the reference tyre.

Table 5

<i>Number of sets of candidate tyres between two successive runs of the reference tyre</i>	<i>Set of candidate tyres to be qualified</i>	<i>R<sub>a</sub></i>
1 R1-T1-R2	T1	$R_a = 1/2 (R_1 + R_2)$
2 R1-T1-T2-R2	T1	$R_a = 2/3 R_1 + 1/3 R_2$
	T2	$R_a = 1/3 R_1 + 2/3 R_2$
3 R1-T1-T2-T3-R2	T1	$R_a = 3/4 R_1 + 1/4 R_2$
	T2	$R_a = 1/2 (R_1 + R_2)$
	T3	$R_a = 1/4 R_1 + 3/4 R_2$

2.2.2.7.4. Calculation of braking force coefficient, BFC

BFC(R) and BFC(T) are calculated according to Table 6:

Table 6

<i>Tyre type</i>	<i>Braking force coefficient is</i>
Reference tyre	$BFC(R) = R_a/g$
Candidate tyre	$BFC(T) = T_a/g$
g is the acceleration due to gravity (rounded to 9.81 m·s <sup>-2</sup> ).	

T<sub>a</sub> (a = 1, 2, etc.) is the average of the AD values for a test of a candidate tyre.

2.2.2.7.5. Calculation of the relative wet grip performance index of the tyre

The Wet grip index represents the relative performance of the candidate tyre compared to the reference tyre. The way to obtain it depends on the test configuration as defined in paragraph 2.2.2.2. of this annex. The wet grip index of the tyre is calculated as reported into Table 7:

Table 7

Configuration C1: candidate tyres on both axles	$\text{Wet Grip Index} = \frac{BFC(T)}{BFC(R)}$
Configuration C2: candidate tyres on front axle and reference tyres on rear axle	$\text{Wet Grip Index} = \frac{BFC(T) \times [a + b + h \times BFC(R)] - a \times BFC(R)}{BFC(R) \times [b + h \times BFC(T)]}$
Configuration C3: reference tyres on front axle and candidate tyres on rear axle	$\text{Wet Grip Index} = \frac{BFC(T) \times [-a - b + h \times BFC(R)] + b \times BFC(R)}{BFC(R) \times [-a + h \times BFC(T)]}$

Where:

"G": centre of gravity of the loaded vehicle

"m": mass (in kilograms) of the loaded vehicle

- "a": horizontal distance between front axle and centre of gravity of the loaded vehicle (m)
  - "b": horizontal distance between rear axle and centre of gravity of the loaded vehicle
  - "h": vertical distance between ground level and centre of gravity of the loaded vehicle (m).
- N.B.* When "h" is not precisely known, these worst case values shall apply:  
1.2 for configuration C2, and 1.5 for configuration C3
- " $\gamma$ " loaded vehicle acceleration [ $\text{m}\cdot\text{s}^{-2}$ ]
  - "g" acceleration due to the gravity [ $\text{m}\cdot\text{s}^{-2}$ ]
  - "X1" longitudinal (X-direction) reaction of the front tyre on the road
  - "X2" longitudinal (X-direction) reaction of the rear tyre on the road
  - "Z1" normal (Z-direction) reaction of the front tyre on the road
  - "Z2" normal (Z-direction) reaction of the rear tyre on the road

Figure 1

**Nomenclature explanation related to grip index of the tyre**

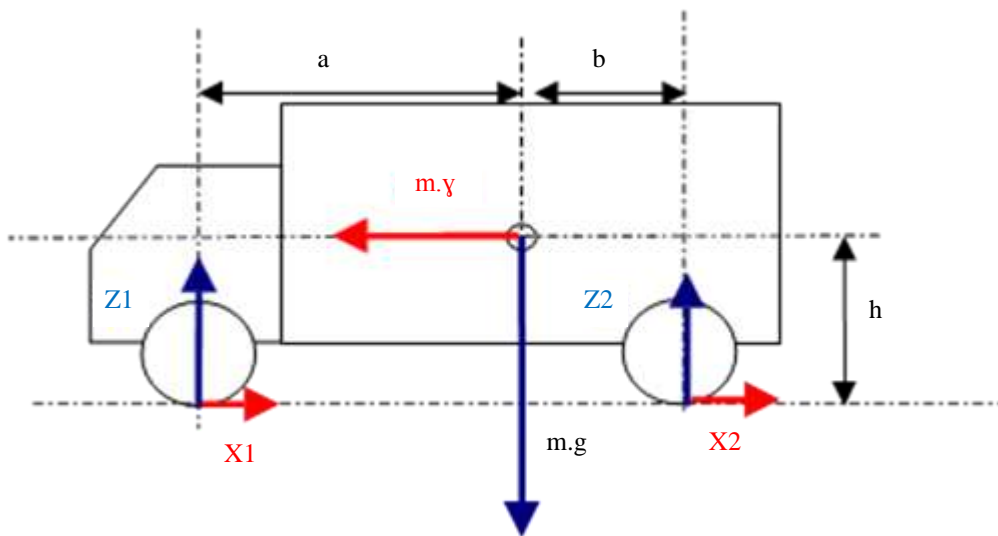

2.2.2.8. Wet grip performance comparison between a candidate tyre and a reference tyre using a control tyre

When the candidate tyre size is significantly different from the reference tyre, a direct comparison on the same vehicle may be not possible. This approach uses an intermediate tyre, hereinafter called the control tyre.

2.2.2.8.1. The principle lies upon the use of a control tyre and 2 different vehicles for assessing a candidate tyre in comparison with a reference tyre.

One vehicle can fit the reference tyre and the control tyre, the other the control tyre and the candidate tyre. All conditions are in conformity with paragraphs 2.2.1.2. to 2.2.2.5. above.

2.2.2.8.2. The first assessment is a comparison between the control tyre and the reference tyre. The result (Wet Grip Index 1) is the relative efficiency of the control tyre compared to the reference tyre.

2.2.2.8.3. The second assessment is a comparison between the candidate tyre and the control tyre. The result (Wet Grip Index 2) is the relative efficiency of the candidate tyre compared to the control tyre.

The second assessment is done on the same track as the first one and within one week maximum. The wetted surface temperature shall be in the range of  $\pm 5^{\circ}\text{C}$  of the temperature of the first assessment. The control tyre set (4 or 6 tyres) is physically the same set as the set used for the first assessment.

2.2.2.8.4. The wet grip index of the candidate tyre compared to the reference tyre is deduced by multiplying the relative efficiencies calculated above:

(Wet Grip Index 1 · Wet Grip Index 2)

*Note:* When the test expert decides to use an SRTT tyre as a control tyre (i.e. in the test procedure two SRTTs are compared directly instead of an SRTT with a control tyre) the result of the comparison between the SRTTs is called the "local shift factor".

It is permitted to use a previous SRTTs comparison.

The comparison results shall be checked periodically.

2.2.2.8.5. Selection of a set of tyres as a control tyre set

A "control tyre" set is a group of identical tyres made in the same factory during a one week period.

2.2.2.8.6. Reference and control tyres

Before the first assessment (control tyre / reference tyre), normal storage conditions can be used. It is necessary that all the tyres of a control tyre set have been stored in the same conditions.

2.2.2.8.7. Storage of control tyres

As soon as the control tyre set has been assessed in comparison with the reference tyre, specific storage conditions shall be applied for control tyres replacement.

2.2.2.8.8. Replacement of reference and control tyres

When irregular wear or damage results from tests, or when wear influences the test results, the use of the tyre shall be discontinued.



## Annex 5 – Appendix

### Test reports examples of wet grip index

*Example 1:* Test report of wet grip index using trailer method

Test report number:

Test date:

Type of road surface:

Texture depth (mm):

$\mu$  peak (SRTT14 E1136) :

or BPN:

Speed (km/h):

Water depth (mm):

No.		1	2	3	4	5	6	7	8	9	10
Size											
Service description											
Tyre identification											
Rim											
Pattern											
Load (N)											
Pressure (kPa)											
$\mu$ peak	1										
	2										
	3										
	4										
	5										
	6										
	7										
	8										
Average											
Standard deviation $\sigma$											
$(\sigma/\text{average}) \leq 5$ per cent											
Ra, Adjusted											
Wet grip index											
Surface temp. (°C)											
Ambient temp. (°C)											
Remarks											

Example 2: Test report of wet grip index using passenger car method

Driver:	Test date:	
Track:	Passenger car:	Initial speed (km/h):
Texture depth (mm):	Brand:	Final speed (km/h):
BPN:	Model:	
Water depth (mm):	Type:	

No.	1	2	3	4	5	
Brand	Uniroyal	TYRE B	TYRE C	TYRE D	Uniroyal	
Pattern	ASTM F 2493 SRTT16	PATTERN B	PATTERN C	PATTERN D	ASTM F 2493 SRTT16	
Size	P225/60R16	SIZE B	SIZE C	SIZE D	P225/60R16	
Service description	97S	LI/SS	LI/SS	LI/SS	97S	
Tyre identification	XXXXXXXXX	YYYYYYYYY	ZZZZZZZ	NNNNNNNNN	XXXXXXXXX	
Rim						
Front axle pressure (kPa)						
Rear axle pressure (kPa)						
Front axle load (kg)						
Rear axle load (kg)						
Wet surface temp (°C)						
Ambient temp (°C)						
	<i>Braking distance (m)</i>	<i>Average deceleration (m/s<sup>2</sup>)</i>	<i>Braking distance (m)</i>	<i>Average deceleration (m/s<sup>2</sup>)</i>	<i>Braking distance (m)</i>	<i>Average deceleration (m/s<sup>2</sup>)</i>
Measurement	1					
	2					
	3					
	4					
	5					
	6					
	7					
	8					
	9					
	10					
Average AD (m/s <sup>2</sup> )						
Standard deviation (m/s <sup>2</sup> )						
Validation of results Coeff. of variation (per cent) < 3 per cent						
Adjusted average AD of ref. tyre: R <sub>a</sub> (m/s <sup>2</sup> )						
BFC(R) reference tyre (SRTT16)						
BFC(T) candidate tyre						
Wet grip index (%)						

## Annex 6

### Test procedure for measuring rolling resistance

#### 1. Test methods

The alternative measurement methods listed below are given in this Regulation. The choice of an individual method is left to the tester. For each method, the test measurements shall be converted to a force acting at the tyre/drum interface. The measured parameters are:

- (a) In the force method: the reaction force measured or converted at the tyre spindle;<sup>1</sup>
- (b) In the torque method: the torque input measured at the test drum;<sup>2</sup>
- (c) In the deceleration method: the measurement of deceleration of the test drum and tyre assembly;<sup>2</sup>
- (d) In the power method: the measurement of the power input to the test drum.<sup>2</sup>

#### 2. Test equipment

##### 2.1. Drum specifications

###### 2.1.1. Diameter

The test dynamometer shall have a cylindrical flywheel (drum) with a diameter of at least 1.7 m.

The  $F_r$  and  $C_r$  values shall be expressed relative to a drum diameter of 2.0 m. If drum diameter different than 2.0 m is used, a correlation adjustment shall be made following the method in paragraph 6.3. of this annex.

###### 2.1.2. Surface

The surface of the drum shall be smooth steel. Alternatively, in order to improve skim test reading accuracy, a textured surface may also be used, which should be kept clean.

The  $F_r$  and  $C_r$  values shall be expressed relative to the "smooth" drum surface. If a textured drum surface is used, see Appendix 1, paragraph 7.

###### 2.1.3. Width

The width of the drum test surface shall exceed the width of the test tyre contact patch.

---

<sup>1</sup> This measured value also includes the bearing and aerodynamic losses of the wheel and tyre which are also to be considered for further data interpretation.

<sup>2</sup> The measured value in the torque, deceleration and power methods also includes the bearing and aerodynamic losses of the wheel, the tyre, and the drum which are also to be considered for further data interpretation.

- 2.2. Measuring rim (see Appendix 2)  
The tyre shall be mounted on a steel or light alloy measuring rim, as follows:
- (a) For Class C1 tyres, the width of the rim shall be as defined in ISO 4000-1:2010,
  - (b) For Class C2 and C3 tyres, the width of the rim shall be as defined in ISO 4209 1:2001.
- In cases where the width is not defined in the above mentioned ISO Standards, the rim width as defined by one of the standards organizations as specified in Appendix 4 may be used.
- 2.3. Load, alignment, control and instrumentation accuracies  
Measurement of these parameters shall be sufficiently accurate and precise to provide the required test data. The specific and respective values are shown in Appendix 1.
- 2.4. Thermal environment
- 2.4.1. Reference conditions  
The reference ambient temperature, measured at a distance not less than 0.15 m and not more than 1 m from the tyre sidewall, shall be 25 °C.
- 2.4.2. Alternative conditions  
If the test ambient temperature is different from the reference ambient temperature, the rolling resistance measurement shall be corrected to the reference ambient temperature in accordance with paragraph 6.2. of this annex.
- 2.4.3. Drum surface temperature.  
Care should be taken to ensure that the temperature of the test drum surface is the same as the ambient temperature at the beginning of the test.
3. Test conditions
- 3.1. General  
The test consists of a measurement of rolling resistance in which the tyre is inflated and the inflation pressure allowed to build up, i.e., "capped air".
- 3.2. Test speeds  
The value shall be obtained at the appropriate drum speed specified in Table 1.

Table 1  
**Test Speeds (in km/h)**

<i>Tyre Class</i>	<i>C1</i>	<i>C2 and C3</i>	<i>C3</i>	
Load index	All	LI ≤ 121	LI > 121	
Speed symbol	All	All	J 100 km/h and lower or tyres not marked with speed symbol	K 110 km/h and higher
Speed	80	80	60	80

3.3. Test load

The standard test load shall be computed from the values shown in Table 2 and shall be kept within the tolerance specified in Appendix 1.

3.4. Test inflation pressure

The inflation pressure shall be in accordance with that shown in Table 2 and shall be capped with the accuracy specified in paragraph 4. of Appendix 1 to this annex.

Table 2  
**Test loads and inflation pressures**

Tyre Class	C1 <sup>(a)</sup>		C2, C3
	Standard load	Reinforced or extra load	
Load - % of maximum load capacity	80	80	85 <sup>(b)</sup> (% of single load)
Inflation pressure kPa	210	250	Corresponding to maximum load capacity for single application <sup>(c)</sup>

*Note:* The inflation pressure shall be capped with the accuracy specified in paragraph 4. of Appendix 1 to this annex.

- <sup>(a)</sup> For those passenger car tyres belonging to categories which are not shown in ISO 4000-1:2010, the inflation pressure shall be the inflation pressure recommended by the tyre manufacturer, corresponding to the maximum tyre load capacity, reduced by 30 kPa.
- <sup>(b)</sup> As a percentage of single load, or 85 per cent of maximum load capacity for single application specified in applicable tyre standards manuals if not marked on tyre.
- <sup>(c)</sup> Inflation pressure marked on sidewall, or if not marked on sidewall, as specified in applicable tyre standards manuals corresponding to maximum load capacity for single application.

3.5. Duration and speed.

When the deceleration method is selected, the following requirements apply:

- (a) The deceleration  $j$  shall be determined in differential  $d\omega/dt$  or discrete  $\Delta\omega/\Delta t$  form, where  $\omega$  is angular velocity,  $t$  – time;  
If the differential form  $d\omega/dt$  is used, then the recommendations of Appendix 5 to this annex are to be applied.
- (b) For duration  $\Delta t$ , the time increments shall not exceed 0.5 s;
- (c) Any variation of the test drum speed shall not exceed 1 km/h within one time increment.

4. Test procedure

4.1. General

The test procedure steps described below shall be followed in the sequence given.

- 4.2. Thermal conditioning  
The inflated tyre shall be placed in the thermal environment of the test location for a minimum of:
- (a) 3 hours for Class C1 tyres;
  - (b) 6 hours for Class C2 and C3 tyres.
- 4.3. Pressure adjustment  
After thermal conditioning, the inflation pressure shall be adjusted to the test pressure, and verified 10 minutes after the adjustment is made.
- 4.4. Warm-up  
The warm-up durations shall be as specified in Table 3.

Table 3  
**Warm up durations**

Tyre Class	C1	C2 and C3 <i>LI ≤ 121</i>	C3	
			< 22.5	<i>LI &gt; 121</i> ≥ 22.5
Nominal Rim Diameter	All	All	< 22.5	≥ 22.5
Warm up duration	30 min.	50 min.	150 min.	180 min.

- 4.5. Measurement and recording  
The following shall be measured and recorded (see Figure 1):
- (a) Test speed  $U_n$ ;
  - (b) Load on the tyre normal to the drum surface  $L_m$ ;
  - (c) The initial test inflation pressure as defined in paragraph 3.3. above;
  - (d) The coefficient of rolling resistance measured  $C_r$ , and its corrected value  $C_{rc}$ , at 25 °C and for a drum diameter of 2 m;
  - (e) The distance from the tyre axis to the drum outer surface under steady state  $r_L$ ;
  - (f) Ambient temperature  $t_{amb}$ ;
  - (g) Test drum radius  $R$ ;
  - (h) Test method chosen;
  - (i) Test rim (size and material);
  - (j) Tyre size, manufacturer, type, identity number (if one exists), speed symbol, load index, DOT number (Department of Transportation).

Figure 1

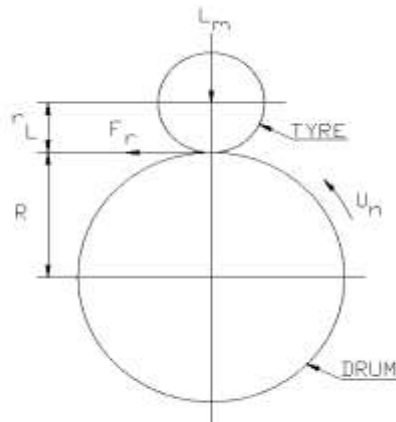

All the mechanical quantities (forces, torques) will be orientated in accordance with the axis systems specified in ISO 8855:1991.

The directional tyres shall be run in their specified rotation sense.

4.6. Measurement of parasitic losses

The parasitic losses shall be determined by one of the following procedures given in paragraph 4.6.1. or 4.6.2. below.

4.6.1. Skim test reading

Skim test reading follows the procedure below:

- (a) Reduce the load to maintain the tyre at the test speed without slippage.<sup>3</sup>

The load values should be as follows:

- (i) Class C1 tyres: recommended value of 100 N; not to exceed 200 N;
  - (ii) Class C2 tyres: recommended value of 150 N; not to exceed 200 N for machines designed for Class C1 tyre measurement or 500 N for machine designed for Class C2 and C3 tyres;
  - (iii) Class C3 tyres: recommended value of 400 N; not to exceed 500 N.
- (b) Record the spindle force  $F_t$ , input torque  $T_i$ , or the power, whichever applies;<sup>3</sup>
- (c) Record the load on the tyre normal to the drum surface  $L_m$ .<sup>3</sup>

<sup>3</sup> With the exception of the force method, the measured value includes the bearing and aerodynamic losses of the wheel, the tyre, and the drum losses which also need to be considered. It is known that the spindle and drum bearing frictions depend on the applied load. Consequently, it is different for the loaded system measurement and the skim test reading. However, for practical reasons, this difference can be disregarded.

4.6.2. Deceleration method

The deceleration method follows the procedure below:

- (a) Remove the tyre from the test surface;
- (b) Record the deceleration of the test drum  $\Delta\omega_{D0}/\Delta t$  and that of the unloaded tyre  $\Delta\omega_{T0}/\Delta t$  or record the deceleration of the test drum  $j_{D0}$  and that of the unloaded tyre  $j_{T0}$  in exact or approximate form in accordance with paragraph 3.5. above.

4.7. Allowance for machines exceeding  $\sigma_m$  criterion

The steps described in paragraphs 4.3. to 4.5. above shall be carried out once only, if the measurement standard deviation determined in accordance with paragraph 6.5. below is:

- (a) Not greater than 0.075 N/kN for Class C1 and C2 tyres;
- (b) Not greater than 0.06 N/kN for Class C3 tyres.

If the measurement standard deviation exceeds this criterion, the measurement process will be repeated  $n$  times as described in paragraph 6.5. below. The rolling resistance value reported shall be the average of the  $n$  measurements.

5. Data interpretation

5.1. Determination of parasitic losses

5.1.1. General

The laboratory shall perform the measurements described in paragraph 4.6.1. above for the force, torque and power methods or those described in paragraph 4.6.2. above for the deceleration method, in order to determine precisely in the test conditions (load, speed, temperature) the tyre spindle friction, the tyre and wheel aerodynamic losses, the drum (and as appropriate, engine and/or clutch) bearing friction, and the drum aerodynamic losses.

The parasitic losses related to the tyre/drum interface  $F_{pl}$  expressed in newton shall be calculated from the force  $F_t$  torque, power or the deceleration, as shown in paragraphs 5.1.2. to 5.1.5. below.

5.1.2. Force method at tyre spindle

Calculate:  $F_{pl} = F_t(1 + r_L/R)$

Where:

- $F_t$  is the tyre spindle force in newton (see paragraph 4.6.1. above),
- $r_L$  is the distance from the tyre axis to the drum outer surface under steady state conditions, in meter,
- $R$  is the test drum radius, in meter.



5.1.3. Torque method at drum axis

Calculate:  $F_{pl} = T_t/R$

Where:

$T_t$  is the input torque in newton meter, as determined in paragraph 4.6.1,

$R$  is the test drum radius, in meter.

5.1.4. Power method at drum axis

Calculate:  $F_{pl} = \frac{3,6V \times A}{U_n}$

Where:

$V$  is the electrical potential applied to the machine drive, in volt,

$A$  is the electric current drawn by the machine drive, in ampere,

$U_n$  is the test drum speed, in kilometer per hour.

5.1.5. Deceleration method

Calculate the parasitic losses  $F_{pl}$ , in newton.

$$F_{pl} = \frac{I_D}{R} \left( \frac{\Delta\omega_{D0}}{\Delta t_0} \right) + \frac{I_T}{R_r} \left( \frac{\Delta\omega_{T0}}{\Delta_0} \right)$$

Where:

$I_D$  is the test drum inertia in rotation, in kilogram meter squared,

$R$  is the test drum surface radius, in meter,

$\omega_{D0}$  is the test drum angular speed, without tyre, in radians per second,

$\Delta t_0$  is the time increment chosen for the measurement of the parasitic losses without tyre, in second,

$I_T$  is the spindle, tyre and wheel inertia in rotation, in kilogram meter squared,

$R_r$  is the tyre rolling radius, in meter,

$\omega_{T0}$  is the tyre angular speed, unloaded tyre, in radian per second.

or

$$F_{pl} = \frac{I_D}{R} j_{D0} + \frac{I_T}{R_r} j_{T0}$$

Where:

$I_D$  is the test drum inertia in rotation, in kilogram meter squared,

$R$  is the test drum surface radius, in meter,

$j_{D0}$  is the deceleration of the test drum, without tyre, in radians per second squared,

$I_T$  is the spindle, tyre and wheel inertia in rotation, in kilogram meter squared,  
 $R_r$  is the tyre rolling radius, in meter,  
 $j_{T0}$  is the deceleration of unloaded tyre, in radians per second squared.

5.2. Rolling resistance calculation

5.2.1. General

The rolling resistance  $F_r$ , expressed in newton, is calculated using the values obtained by testing the tyre to the conditions specified in this international standard and by subtracting the appropriate parasitic losses  $F_{pl}$ , obtained according to paragraph 5.1. above.

5.2.2. Force method at tyre spindle

The rolling resistance  $F_r$ , in newton, is calculated using the equation

$$F_r = F_t[1 + (r_L/R)] - F_{pl}$$

Where:

$F_t$  is the tyre spindle force in newton,  
 $F_{pl}$  represents the parasitic losses as calculated in paragraph 5.1.2. above,  
 $r_L$  is the distance from the tyre axis to the drum outer surface under steady-state conditions, in meter,  
 $R$  is the test drum radius, in meter.

5.2.3. Torque method at drum axis

The rolling resistance  $F_r$ , in newton, is calculated with the equation

$$F_r = \frac{T_t}{R} - F_{pl}$$

Where:

$T_t$  is the input torque, in newton meter,  
 $F_{pl}$  represents the parasitic losses as calculated in paragraph 5.1.3. above,  
 $R$  is the test drum radius, in meter.

5.2.4. Power method at drum axis

The rolling resistance  $F_r$ , in newton, is calculated with the equation:

$$F_r = \frac{3.6V \times A}{U_n} - F_{pl}$$

Where:

$V$  = is the electrical potential applied to the machine drive, in volt,  
 $A$  = is the electric current drawn by the machine drive, in ampere,

- $U_n$  = is the test drum speed, in kilometer per hour,  
 $F_{pl}$  = represents the parasitic losses as calculated in paragraph 5.1.4. above.

5.2.5. Deceleration method

The rolling resistance  $Fr$ , in newton, is calculated using the equation:

$$Fr = \frac{I_D}{R} \left( \frac{\Delta\omega_V}{\Delta t_V} \right) + \frac{R \times I_T}{R_r^2} \left( \frac{\Delta\omega_V}{\Delta t_V} \right) - F_{pl}$$

Where:

- $I_D$  is the test drum inertia in rotation, in kilogram meter squared,  
 $R$  is the test drum surface radius, in meter,  
 $F_{pl}$  represents the parasitic losses as calculated in paragraph 5.1.5. above,  
 $\Delta t_V$  is the time increment chosen for measurement, in second,  
 $\Delta\omega_V$  is the test drum angular speed increment, without tyre, in radian per second,  
 $I_T$  is the spindle, tyre and wheel inertia in rotation, in kilogram meter squared,  
 $R_r$  is the tyre rolling radius, in meter,  
 $F_r$  is the rolling resistance, in newton.

or

$$Fr = \frac{I_D}{R} j_V + \frac{R \times I_T}{R_r^2} j_V - F_{pl}$$

Where:

- $I_D$  is the test drum inertia in rotation, in kilogram meter squared,  
 $R$  is the test drum surface radius, in meter,  
 $F_{pl}$  represents the parasitic losses as calculated in paragraph 5.1.5. above,  
 $j_V$  is the deceleration of the test drum, in radians per second squared,  
 $I_T$  is the spindle, tyre and wheel inertia in rotation, in kilogram meter squared,  
 $R_r$  is the tyre rolling radius, in meter,  
 $F_r$  is the rolling resistance, in newton.

6. Data analysis

6.1. Rolling resistance coefficient

The rolling resistance coefficient  $C_r$  is calculated by dividing the rolling resistance by the load on the tyre:

$$C_r = \frac{F_r}{L_m}$$

Where:

$F_r$  is the rolling resistance, in newton,

$L_m$  is the test load, in kN.

6.2. Temperature correction

If measurements at temperatures other than 25 °C are unavoidable (only temperatures not less than 20 °C or more than 30 °C are acceptable), then a correction for temperature shall be made using the following equation, with:

$F_{r25}$  is the rolling resistance at 25 °C, in Newton:

$$F_{r25} = F_r [1 + K(t_{amb} - 25)]$$

Where:

$F_r$  is the rolling resistance, in Newton,

$t_{amb}$  is the ambient temperature, in degree Celsius,

$K$  is equal to:

0.008 for Class C1 tyres

0.010 for Class C2 and C3 tyres with a load index equal or lower than 121

0.006 for Class C3 tyres with a load index greater than 121

6.3. Drum diameter correction

Test results obtained from different drum diameters shall be compared by using the following theoretical formula:

$$F_{r02} \cong KF_{r01}$$

With:

$$K = \sqrt{\frac{(R_1/R_2)(R_2 + r_T)}{(R_1 + r_T)}}$$

Where:

$R_1$  is the radius of drum 1, in meter,

$R_2$  is the radius of drum 2, in meter,

$r_T$  is one-half of the nominal design tyre diameter, in meter,

$F_{r01}$  is the rolling resistance value measured on drum 1, in newton,

$F_{r02}$  is the rolling resistance value measured on drum 2, in newton.

6.4. Measurement result

Where  $n$  measurements are greater than 1, if required by paragraph 4.6. above, the measurement result shall be the average of the  $C_r$  values obtained for the  $n$  measurements, after the corrections described in paragraphs 6.2. and 6.3. above have been made.

6.5. The laboratory shall ensure that, based on a minimum of three measurements, the machine maintains the following values of  $\sigma_m$ , as measured on a single tyre:

$\sigma_m \leq 0.075$  N/kN for tyres of Classes C1 and C2

$\sigma_m \leq 0.06$  N/kN for tyres of Class C3

If the above requirement for  $\sigma_m$  is not met, the following formula shall be applied to determine the minimum number of measurements  $n$  (rounded to the immediate superior integer value) that are required by the machine to qualify for conformance with this Regulation.

$$n = (\sigma_m / x)^2$$

Where:

$x = 0.075$  N/kN for tyres of Classes C1 and C2

$x = 0.06$  N/kN for tyres of Class C3

If a tyre needs to be measured several times, the tyre/wheel assembly shall be removed from the machine between the successive measurements.

If the removal/refitting operation duration is less than 10 minutes, the warm-up durations indicated in paragraph 4.3. above may be reduced to:

- (a) 10 minutes for tyres of Class C1;
- (b) 20 minutes for tyres of Class C2;
- (c) 30 minutes for tyres of Class C3.

6.6. Monitoring of the laboratory control tyre shall be carried out at intervals no greater than one month. Monitoring shall include a minimum of 3 separate measurements taken during this one month period. The average of the 3 measurements taken during a given one-month period shall be evaluated for drift from one monthly evaluation to another.

## Annex 6 - Appendix 1

### Test equipment tolerances

1. Purpose  
The limits specified in this annex are necessary in order to achieve suitable levels of repeatable test results, which can also be correlated among various test laboratories. These tolerances are not meant to represent a complete set of engineering specifications for test equipment; rather, they should serve as guidelines for achieving reliable test results.
2. Test rims
  - 2.1. Width  
For passenger car tyre rims (C1 tyres), the test rim width shall be the same as the measuring rim determined in ISO 4000-1: 2010, clause 6.2.2.  
For truck and bus tyres (C2 and C3), the rim width shall be the same as the measuring rim determined in ISO 4209-1:2001, clause 5.1.3.  
In cases where the width is not defined in the above mentioned ISO Standards, the rim width as defined by one of the standards organizations as specified in Appendix 4 to Annex 6 may be used.
  - 2.2. Run-out  
Run-out shall meet the following criteria:
    - (a) Maximum radial run-out: 0.5 mm;
    - (b) Maximum lateral run-out: 0.5 mm.
3. Drum / tyre alignment  
General:  
Angle deviations are critical to the test results.
  - 3.1. Load application  
The direction of tyre loading application shall be kept normal to the test surface and shall pass through the wheel centre within
    - (a) 1 mrad for the force and deceleration methods;
    - (b) 5 mrad for the torque and power methods.
  - 3.2. Tyre alignment
    - 3.2.1. Camber angle  
The plane of the wheel shall be perpendicular to the test surface within 2 mrad for all methods.
    - 3.2.2. Slip angle  
The plane of the tyre shall be parallel to the direction of the test surface motion within 1 mrad for all methods.

4. Control accuracy

Test conditions shall be maintained at their specified values, independent of perturbations induced by the tyre and rim non-uniformity, such that the overall variability of the rolling resistance measurement is minimized. In order to meet this requirement, the average value of measurements taken during the rolling resistance data collection period shall be within the accuracies stated as follows:

- (a) Tyre loading:
  - (i) For  $LI \leq 121$   $\pm 20$  N or  $\pm 0.5$  per cent, whichever is greater;
  - (ii) For  $LI > 121$   $\pm 45$  N or  $\pm 0.5$  per cent whichever is greater;
- (b) Cold inflation pressure:  $\pm 3$  kPa;
- (c) Surface speed:
  - (i)  $\pm 0.2$  km/h for the power, torque and deceleration methods;
  - (ii)  $\pm 0.5$  km/h for the force method;
- (d) Time:
  - (i)  $\pm 0.02$  s for the time increments specified in Annex 6, paragraph 3.5.(b) for the data acquisition in the deceleration method in  $\Delta\omega/\Delta t$  form;
  - (ii)  $\pm 0.2$  per cent for the time increments specified in Annex 6, paragraph 3.5.(a) for the data acquisition in the deceleration method in  $d\omega/dt$  form;
  - (iii)  $\pm 5$  per cent for the other time durations specified in Annex 6.

5. Instrumentation accuracy

The instrumentation used for readout and recording of test data shall be accurate within the tolerances stated below:

Parameter	Load Index ≤ 121	Load Index > 121
Tyre load	±10 N or ±0.5 % <sup>(a)</sup>	±30 N or ±0.5 % <sup>(a)</sup>
Inflation pressure	±1 kPa	±1.5 kPa
Spindle force	±0.5 N or ±0.5 % <sup>(a)</sup>	±1.0 N or ±0.5 % <sup>(a)</sup>
Torque input	±0.5 Nm or ±0.5 % <sup>(a)</sup>	±1.0 Nm or ±0.5 % <sup>(a)</sup>
Distance	±1 mm	±1 mm
Electrical power	±10 W	±20 W
Temperature	±0.2 °C	
Surface speed	±0.1 km/h	
Time	±0.01 s - ±0.1 % - ±10 s <sup>(b)</sup>	
Angular velocity	±0.1 %	

<sup>(a)</sup> Whichever is greater.

<sup>(b)</sup> ±0.01 s for the time increments specified in Annex 6, paragraph 3.5.(b) for the data acquisition in the deceleration method in  $\Delta\omega/\Delta t$  form  
±0.1 per cent for the time increments specified in Annex 6, paragraph 3.5.(a) for the data acquisition in the deceleration method in  $d\omega/dt$  form  
± 10 sec for the other time durations specified in Annex 6.

6. Compensation for load/spindle force interaction and load misalignment for the force method only

Compensation of both load/spindle force interaction ("cross talk") and load misalignment may be achieved either by recording the spindle force for both forward and reverse tyre rotation or by dynamic machine calibration. If spindle force is recorded for forward and reverse directions (at each test condition), compensation is achieved by subtracting the "reverse" value from the "forward" value and dividing the result by two. If dynamic machine calibration is intended, the compensation terms may be easily incorporated in the data reduction.

In cases where reverse tyre rotation immediately follows the completion of the forward tyre rotation, a warm-up time for reverse tyre rotation shall be at least 10 minutes for Class C1 tyres and 30 minutes for all other tyre types.

7. Test surface roughness

The roughness, measured laterally, of the smooth steel drum surface shall have a maximum centreline average height value of 6.3 µm.

*Note:* In cases where a textured drum surface is used instead of a smooth steel surface, this fact is noted in the test report. The surface texture shall then be 180 µm deep (80 grit) and the laboratory is responsible for maintaining the surface roughness characteristics. No specific correction factor is recommended for cases where a textured drum surface is used.



## Annex 6 - Appendix 2

### Measuring rim width

1. Class C1 tyres

The measuring rim width  $R_m$  is equal to the product of the nominal section width  $S_N$  and the coefficient  $K_2$ :

$$R_m = K_2 \times S_N$$

rounded to the nearest standardized rim, where  $K_2$  is the rim/section width ratio coefficient. For tyres mounted on 5° drop-centre rims with a nominal diameter expressed by a two-figure code:

$$K_2 = 0.7 \text{ for nominal aspect ratios 95 to 75}$$

$$K_2 = 0.75 \text{ for nominal aspect ratios 70 to 60}$$

$$K_2 = 0.8 \text{ for nominal aspect ratios 55 and 50}$$

$$K_2 = 0.85 \text{ for nominal aspect ratio 45}$$

$$K_2 = 0.9 \text{ for nominal aspect ratios 40 to 30}$$

$$K_2 = 0.92 \text{ for nominal aspect ratios 20 and 25}$$

2. Class C2 and C3 tyres

The measuring rim width  $R_m$  is equal to the product of the nominal section width  $S_N$ , and the coefficient  $K_4$ :

$$R_m = K_4 \times S_N \text{ rounded to the nearest standardized rim width.}$$

Table 1  
**Coefficients for determining measuring rim width**

<i>Tyre structure code</i>	<i>Type of rim</i>	<i>Nominal aspect ratio H/S</i>	<i>Measuring rim/ section ratio <math>K_4</math></i>
B, D, R	5° tapered	100 to 75	0.70
		70 and 65	0.75
		60	0.75
		55	0.80
		50	0.80
		45	0.85
		40	0.90
		15° tapered (drop-centre)	90 to 65
	60		0.80
	55		0.80
	50		0.80
	45		0.85
	40		0.85

*Note:* Other factors may be established for new tyre concepts (structures).

## Annex 6 - Appendix 3

### Test report and test data (Rolling resistance)

#### *Part 1: Report*

1. Type Approval Authority or Technical Service: .....
2. Name and address of applicant: .....
3. Test report No.: .....
4. Manufacturer and brand name or trade description: .....
5. Tyre class (C1, C2 or C3): .....
6. Category of use: .....
7. Rolling resistance coefficient  
(temperature and drum diameter corrected): .....
8. Comments (if any): .....
9. Date: .....
10. Signature: .....

#### *Part 2: Test data*

1. Date of test: .....
2. Test machine identification and drum diameter/surface: .....
3. Test tyre details: .....
- 3.1. Tyre size designation and service description: .....
- 3.2. Tyre brand and trade description: .....
- 3.3. Reference inflation pressure: .....kPa
4. Test data: .....
- 4.1. Measurement method: .....
- 4.2. Test speed: ..... km/h
- 4.3. Load: ..... N
- 4.4. Test inflation pressure, initial: .....kPa
- 4.5. Distance from the tyre axis to the drum outer surface under steady state  
conditions,  $r_L$ : ..... m
- 4.6. Test rim width and material: .....
- 4.7. Ambient temperature: ..... °C
- 4.8. Skim test load (except deceleration method): ..... N
5. Rolling resistance coefficient: .....
- 5.1. Initial value (or average in the case of more than 1): .....N/kN
- 5.2. Temperature corrected: .....N/kN
- 5.3. Temperature and drum diameter corrected: .....N/kN

## **Annex 6 – Appendix 4**

### **Tyre standards organizations**

1. The Tire and Rim Association, Inc. (TRA)
2. The European Tyre and Rim Technical Organisation (ETRTO)
3. The Japan Automobile Tyre Manufacturers' Association (JATMA)
4. The Tyre and Rim Association of Australia (TRAA)
5. South Africa Bureau of Standards (SABS)
6. China Association for Standardization (CAS)
7. Indian Tyre Technical Advisory Committee (ITTAC)
8. International Standards Organisation (ISO)

## Annex 6 – Appendix 5

### Deceleration method: Measurements and data processing for deceleration value obtaining in differential form $d\omega/dt$ .

1. Record dependency "distance-time" of rotating body decelerated from peripheral with a speed range such as 82 to 78 km/h or 62 to 58 km/h dependent on tyre class (Annex 6, paragraph 3.2., Table 1) in a discrete form (Figure 1) for a rotating body:

$$z = f(t_z)$$

Where:

$z$  is a number of body revolutions during deceleration;

$t_z$  is end time of revolution number  $z$  in seconds recorded with 6 digits after zero.

Figure 1

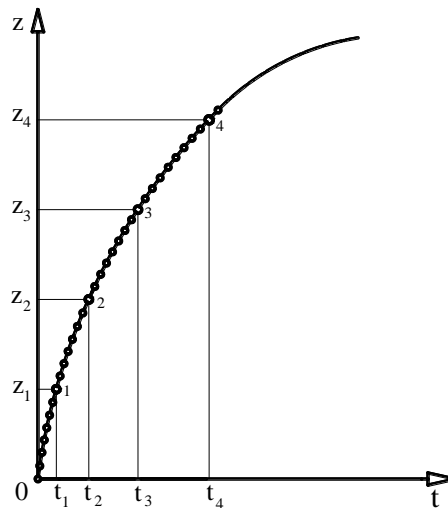

*Note 1:* The lower speed of the recording range may be reduced down to 60 km/h when test speed is 80 km/h and 40 km/h when the test speed is 60 km/h.

2. Approximate recorded dependency by continuous, monotonic, differentiable function:
  - 2.1. Choose the value nearest to the maximum of  $z$  dividable by 4 and divide it into 4 equal parts with bounds:  $0, z_1(t_1), z_2(t_2), z_3(t_3), z_4(t_4)$ .
  - 2.2. Work out the system for 4 equations each of the form:

$$z_m = A \ln \frac{\cos B(T_\Sigma - t_m)}{\cos B T_\Sigma}$$

Where unknowns:

A is a dimensionless constant,

B is a constant in revolutions per second,

$T_{\Sigma}$  is a constant in seconds,

m is the number of bounds shown in figure 1.

Insert in these 4 equations the coordinates of 4-th bound above.

- 2.3. Take constants A, B and  $T_{\Sigma}$  as the solution of the equation system of paragraph 2.2. above using iteration process and approximate measured data by formulae:

$$z(t) = A \ln \frac{\cos B(T_{\Sigma} - t)}{\cos B T_{\Sigma}}$$

Where:

$z(t)$  is the current continuous angular distance in number of revolutions (not only integer values);

t is time in seconds.

*Note 2:* Other approximating functions  $z = f(t_z)$  may be used if their adequacy is proven.

3. Calculate the deceleration j in revolutions per second squared ( $s^{-2}$ ) by the formula:

$$j = AB^2 + \frac{\omega^2}{A}$$

Where:

$\omega$  is the angular speed in revolutions per second ( $s^{-1}$ ).

For the case  $U_n = 80$  km/h;  $\omega = 22.222/R_r$  (or R).

For the case  $U_n = 60$  km/h;  $\omega = 16.666/R_r$  (or R).

4. Estimate the quality of approximation of measured data and its accuracy by parameters:

- 4.1. Standard deviation in percentages:

$$\sigma = \sqrt{\frac{1}{n-1} \sum_1^n \left[ 1 - \frac{z(t)}{z} \right]^2} \times 100\%$$

- 4.2. Coefficient of determination

$$R^2 = 1 - \frac{\sum_1^n [z - z(t)]^2}{\sum_1^n [z - \bar{z}]^2}$$

Where:

$$\bar{z} = \frac{1}{n} \sum_{z=1}^n z = \frac{1}{n} (1 + 2 + \dots + n) = \frac{1+n}{2}$$

*Note 3:* The above calculations for this variant of the deceleration method for tyre rolling resistance measurement can be executed by the computer program "Deceleration Calculator" downloadable from the WP.29 website<sup>1</sup> as well as any software which allows the calculation of nonlinear regression.

---

<sup>1</sup> [http://www.unece.org/trans/main/wp29/wp29wgs/wp29gen/deceleration\\_calculator.html](http://www.unece.org/trans/main/wp29/wp29wgs/wp29gen/deceleration_calculator.html).

## Annex 7

### Procedures for snow performance testing relative to snow tyre for use in severe snow conditions

1. Specific definitions for snow test when different from existing ones
  - 1.1. "*Test run*" means a single pass of a loaded tyre over a given test surface.
  - 1.2. "*Braking test*" means a series of a specified number of ABS-braking test runs of the same tyre repeated within a short time frame.
  - 1.3. "*Traction test*" means a series of a specified number of spin-traction test runs according to ASTM standard F1805-06 of the same tyre repeated within a short time frame.
  - 1.4. "*Acceleration test*" means a series of specified number of traction controlled acceleration test runs of the same tyre repeated within a short timeframe.
2. Spin traction method for Class C1 and C2 tyres (traction force test per paragraph 6.4. (b) of this Regulation)

The test procedure of ASTM standard F1805-06 shall be used to assess snow performance through spin traction values on medium packed snow (The snow compaction index measured with a CTI penetrometer<sup>1</sup> shall be between 70 and 80).

  - 2.1. The test course surface shall be composed of a medium packed snow surface, as characterized in table A2.1 of ASTM standard F1805-06.
  - 2.2. The tyre load for testing shall be as per option 2 in paragraph 11.9.2. of ASTM standard F1805-06.
3. Braking on snow method for Class C1 and C2 tyres
  - 3.1. General conditions
    - 3.1.1. Test course

The braking tests shall be done on a flat test surface of sufficient length and width, with a maximum 2 per cent gradient, covered with packed snow.

The snow surface shall be composed of a hard packed snow base at least 3 cm thick and a surface layer of medium packed and prepared snow about 2 cm thick.

The air temperature, measured about one meter above the ground, shall be between -2 °C and -15 °C; the snow temperature, measured at a depth of about one centimeter, shall be between -4 °C and -15 °C.

It is recommended to avoid direct sunlight, large variations of sunlight or humidity, as well as wind.

---

<sup>1</sup> See appendix of ASTM standard F1805-06 for details.

The snow compaction index measured with a CTI penetrometer<sup>1</sup> shall be between 75 and 85.

3.1.2. Vehicle

The test shall be conducted with a standard production vehicle in good running order and equipped with an ABS system.

The vehicle used shall be such that the loads on each wheel are appropriate to the tyres being tested. Several different tyre sizes can be tested on the same vehicle.

3.1.3. Tyres

The tyres should be "broken-in" prior to testing to remove spew, compound nodules or flashes resulting from the moulding process. The tyre surface in contact with snow shall be cleaned before performing a test.

Tyres shall be conditioned at the outdoor ambient temperature at least two hours before their mounting for tests. Tyre pressures shall then be adjusted to the values specified for the test.

In case a vehicle cannot accommodate both the reference and candidate tyres, a third tyre ("control" tyre) may be used as an intermediate. First test control vs. reference on another vehicle, then test candidate vs. control on the vehicle.

3.1.4. Load and pressure

3.1.4.1. For C1 tyres, the vehicle load shall be such that the resulting loads on the tyres are between 60 per cent and 90 per cent of the load corresponding to the tyre load index.

The cold inflation pressure shall be 240 kPa.

3.1.4.2. For C2 tyres, the vehicle load shall be such that the resulting loads on the tyres are between 60 per cent and 100 per cent of the load corresponding to the tyre load index.

The static tyre load on the same axle should not differ by more than 10 per cent.

The inflation pressure is calculated to run at constant deflection:

For a vertical load higher or equal to 75 per cent of the load capacity of the tyre, a constant deflection is applied, hence the test inflation pressure "Pt" shall be calculated as follows:

$$P_t = P_r \left( \frac{Q_t}{Q_r} \right)^{1.25}$$

Qr is the maximum load associated to the load capacity index of the tyre written on the sidewall

Pr is the reference pressure corresponding to the maximum load capacity Qr

Qt is the static test load of the tyre



For a vertical load lower than 75 per cent of the load capacity of the tyre, a constant inflation pressure is applied, hence the test inflation pressure  $P_t$  shall be calculated as follows:

$$P_t = P_r (0.75)^{1.25} = (0.7)P_r$$

$P_r$  is the reference pressure corresponding to the maximum load capacity  $Q_r$

Check the tyre pressure just prior to testing at ambient temperature.

3.1.5. Instrumentation

The vehicle shall be fitted with calibrated sensors suitable for measurements in winter. There shall be a data acquisition system to store measurements.

The accuracy of measurement sensors and systems shall be such that the relative uncertainty of the measured or computed mean fully developed decelerations is less than 1 per cent.

3.2. Testing sequences

3.2.1. For every candidate tyre and the standard reference tyre, ABS-braking test runs shall be repeated a minimum of 6 times.

The zones where ABS-braking is fully applied shall not overlap.

When a new set of tyres is tested, the runs are performed after shifting aside the vehicle trajectory in order not to brake on the tracks of the previous tyre.

When it is no longer possible not to overlap full ABS-braking zones, the test course shall be re-groomed.

Required sequence:

6 repeats SRTT, then shift aside to test next tyre on fresh surface

6 repeats Candidate 1, then shift aside

6 repeats Candidate 2, then shift aside

6 repeats SRTT, then shift aside

3.2.2. Order of testing:

If only one candidate tyre is to be evaluated, the order of testing shall be:

R1 - T - R2

Where:

R1 is the initial test of the SRTT, R2 is the repeat test of the SRTT and T is the test of the candidate tyre to be evaluated.

A maximum of two candidate tyres may be tested before repeating the SRTT test, for example:

R1 - T1 - T2 - R2.

3.2.3. The comparative tests of SRTT and candidate tyres shall be repeated on two different days.

- 3.3. Test procedure
- 3.3.1. Drive the vehicle at a speed not lower than 28 km/h.
- 3.3.2. When the measuring zone has been reached, the vehicle gear is set into neutral, the brake pedal is depressed sharply by a constant force sufficient to cause operation of the ABS on all wheels of the vehicle and to result in stable deceleration of the vehicle and held down until the speed is lower than 8 km/h.
- 3.3.3. The mean fully developed deceleration between 25 km/h and 10 km/h shall be computed from time, distance, speed, or acceleration measurements.
- 3.4. Data evaluation and presentation of results
- 3.4.1. Parameters to be reported
- 3.4.1.1. For each tyre and each braking test, the mean and standard deviation of the mfdd shall be computed and reported.
- The coefficient of variation CV of a tyre braking test shall be computed as:
- $$CV(\text{tyre}) = \frac{\text{Std.dev}(\text{tyre})}{\text{Mean}(\text{tyre})}$$
- 3.4.1.2. Weighted averages of two successive tests of the SRTT shall be computed taking into account the number of candidate tyres in between:
- In the case of the order of testing R1 - T - R2, the weighted average of the SRTT to be used in the comparison of the performance of the candidate tyre shall be taken to be:
- $$\text{wa}(\text{SRTT}) = (\text{R}_1 + \text{R}_2)/2$$
- Where:
- R<sub>1</sub> is the mean fully developed deceleration for the first test of the SRTT and R<sub>2</sub> is the mean mfdd for the second test of the SRTT.
- In the case of the order of testing R1 - T1 - T2 - R2, the weighted average (wa) of the SRTT to be used in the comparison of the performance of the candidate tyre shall be taken to be:
- wa (SRTT) = 2/3 R<sub>1</sub> + 1/3 R<sub>2</sub> for comparison with the candidate tyre T1; and:
- wa (SRTT) = 1/3 R<sub>1</sub> + 2/3 R<sub>2</sub> for comparison with the candidate tyre T2.
- 3.4.1.3. The snow grip index (SG) in per cent of a candidate tyre shall be computed as:
- $$\text{Snow Grip Index (candidate)} = \frac{\text{Mean (candidate)}}{\text{wa (SRTT)}}$$
- 3.4.2. Statistical validations
- The sets of repeats of measured or computed mfdd for each tyre should be examined for normality, drift, eventual outliers.
- The consistency of the means and standard-deviations of successive braking tests of SRTT should be examined.

The means of two successive SRTT braking tests shall not differ by more than 5 per cent.

The coefficient of variation of any braking test shall be less than 6 per cent.

If those conditions are not met, tests shall be performed again after re-grooming the test course.

3.4.3. In the case where the candidate tyres cannot be fitted to the same vehicle as the SRTT, for example, due to tyre size, inability to achieve required loading and so on, comparison shall be made using intermediate tyres, hereinafter referred to as "control tyres", and two different vehicles. One vehicle shall be capable of being fitted with the SRTT and the control tyre and the other vehicle shall be capable of being fitted with the control tyre and the candidate tyre.

3.4.3.1 The snow grip index of the control tyre relative to the SRTT (SG1) and of the candidate tyre relative to the control tyre (SG2) shall be established using the procedure in paragraphs 3.1. to 3.4.2. above.

The snow grip index of the candidate tyre relative to the SRTT shall be the product of the two resulting snow grip indices that is  $SG1 \times SG2$ .

3.4.3.2. The ambient conditions shall be comparable. All tests shall be completed within the same day.

3.4.3.3. The same set of control tyres shall be used for comparison with the SRTT and with the candidate tyre and shall be fitted in the same wheel positions.

3.4.3.4. Control tyres that have been used for testing shall subsequently be stored under the same conditions as required for the SRTT.

3.4.3.5. The SRTT and control tyres shall be discarded if there is irregular wear or damage or when the performance appears to have been deteriorated.

4. Acceleration method for Class C3 tyres

4.1. According to the definition of C3 tyres reported into paragraph 2.4.3. above, the additional classification for the purpose of this test method only applies:

(a) C3 Narrow (C3N), when the C3 tyre nominal section width is lower than 285 mm

(b) C3Wide (C3W), when the C3 tyre nominal section width is greater or equal to 285 mm

4.2. Methods for measuring snow grip index

Snow performance is based on a test method by which the average acceleration in an acceleration test, of a candidate tyre is compared to that of a standard reference tyre.

The relative performance shall be indicated by a snow grip index (SG).

When tested in accordance with the acceleration test in paragraph 4.7. below, the average acceleration of a candidate snow tyre shall be at least 1.25 compared to one of the two equivalent SRTTs – ASTM F 2870 and ASTM F 2871.

- 4.3. Measuring equipment
- 4.3.1. A sensor suitable for measuring speed and distance covered on snow/ice surface between two speeds must be used.
- To measure vehicle speed, a fifth wheel or non-contact speed-measuring system (including radar, GPS ...) shall be used.
- 4.3.2. The following tolerances shall be respected:
- (a) For speed measurements:  $\pm 1$  per cent (km/h) or 0.5 km/h whichever is greater.
- (b) For distance measurements:  $\pm 1 \times 10^{-1}$  m
- 4.3.3. A display of the measured speed or the difference between the measured speed and the reference speed for the test is recommended inside the vehicle so that the driver can adjust the speed of the vehicle.
- 4.3.4. For Acceleration test covered in paragraph 4.7. below, a display of the slip ratio of the driven tyres is recommended inside the vehicle and shall be used in the particular case of paragraph 4.7.2.1.1. below.

The slip ratio is calculated by

$$\text{Slip Ratio \%} = \left[ \frac{\text{Wheel Speed} - \text{Vehicle Speed}}{\text{Vehicle Speed}} \right] \times 100$$

- (a) Vehicle speed is measured as defined in 4.3.1. above (m/s)
- (b) Wheel speed is calculated on a tyre of the driven axle by measuring its angular velocity and its loaded diameter

$$\text{Wheel Speed} = \pi \times \text{loaded diameter} \times \text{angular speed}$$

Where,  $\pi = 3.1416$  (m/360deg), the loaded diameter (m) and the angular speed (revolution per second = 360 deg/sec).

- 4.3.5. A data acquisition system can be used for storing the measurements.
- 4.4. General conditions
- 4.4.1. Test course
- The test shall be done on a flat test surface of sufficient length and width, with a maximum 2 per cent gradient, covered with packed snow.
- 4.4.1.1 The snow surface shall be composed of a hard packed snow base at least 3 cm thick and a surface layer of medium packed and prepared snow about 2 cm thick.
- 4.4.1.2. The snow compaction index measured with a CTI penetrometer shall be between 80 and 90. Refer to the appendix of ASTM F1805 for additional details on measuring method.
- 4.4.1.3. The air temperature, measured about one meter above the ground, shall be between  $-2$  °C and  $-15$  °C; the snow temperature, measured at a depth of about one centimeter, shall be between  $-4$  °C and  $-15$  °C.

Air temperature shall not vary more than 10 deg C during the test.

- 4.5. Tyres preparation and break-in
- 4.5.1. Fit the test tyres on rims as per ISO 4209-1 using conventional mounting methods. Ensure proper bead seating by the use of a suitable lubricant. Excessive use of lubricant should be avoided to prevent slipping of the tyre on the wheel rim.
- 4.5.2. The tyres should be "broken-in" prior to testing to remove spew, compound nodules or flashes resulting from moulding process.
- 4.5.3. Tyres shall be conditioned at the outdoor ambient temperature at least two hours before their mounting for tests.
- They should be placed such that they all have the same ambient temperature prior to testing and be shielded from the sun to avoid excessive heating by solar radiation.
- The tyre surface in contact with snow shall be cleaned before performing a test.
- Tyre pressures shall then be adjusted to the values specified for the test.
- 4.6. Testing sequence
- If only one candidate tyre is to be evaluated, the order of testing shall be:  
R1, T, R2
- Where:
- R1 is the initial test of the SRTT, R2 is the repeat test of the SRTT and T is the test of the candidate tyre to be evaluated.
- A maximum of 3 candidate tyres may be tested before repeating the SRTT test, for example: R1, T1, T2, T3, R2.
- Recommendations are that the zones where acceleration is fully applied shall not overlap without reworking and when a new set of tyres is tested;
- The runs are performed after shifting the vehicle trajectory in order not to accelerate on the tracks of the previous tyre; when it is no longer possible not to overlap full acceleration zones, the test course should be re-groomed.
- 4.7. Acceleration on snow test procedure for snow grip index of Classes C3N and C3W
- 4.7.1. Principle
- The test method covers a procedure for measuring the snow grip performance of commercial vehicle tyres during acceleration, using a commercial vehicle having a Traction Control System (TCS, ASR, etc.).
- Starting with a defined initial speed, the full throttle is applied to activate the traction control system, the average acceleration is calculated between two defined speeds.
- 4.7.2. Vehicle
- 4.7.2.1. The test shall be conducted with a standard 2 axle commercial vehicle in good running order with:

- (a) Low rear axle weight and an engine powerful enough to maintain the average percentage of slip during the test as required in paragraphs 4.7.5.1. and 4.7.5.2.1. below;
  - (b) A manual gearbox (automatic gearbox with manual shift allowed) having a gear ratio covering the speed range of at least 19 km/h between 4 km/h and 30 km/h;
  - (c) Differential lock on driven axle is recommended to improve repeatability;
  - (d) A standard commercial system controlling/limiting the slip of the driving axle during acceleration (Traction Control, ASR, TCS, etc.).
- 4.7.2.1.1. In the particular case where a standard commercial vehicle equipped with a traction control system is not available, a vehicle without Traction Control/ASR/TCS is permitted provided the vehicle is fitted with a system to display the percentage slip as stated in paragraph 4.3.4. of this annex and a mandatory differential lock on the driven axle used in accordance with operating procedure 4.7.5.2.1. below. If a differential lock is available it shall be used; if the differential lock, however, is not available, the average slip ratio should be measured on the left and right driven wheel.
- 4.7.2.2. The permitted modifications are:
- (a) Those allowing to increase the number of tyre sizes capable to be mounted on the vehicle;
  - (b) Those permitting to install an automatic activation of the acceleration and the measurements.
- Any other modification of the acceleration system is prohibited.
- 4.7.3. Vehicle fitting
- The rear driven axle may be indifferently fitted with 2 or 4 test tyres if respecting the loading by tyre.
- The front steer non driven axle is equipped with 2 tyres having a size suitable for the axle load. These 2 front tyres could be maintained along the test.
- 4.7.4. Load and inflation pressure
- 4.7.4.1. The static load on each rear driven test tyres must be between 20 per cent and 55 per cent of the tested tyre load capacity written on the sidewall.
- The vehicle front steer total static axle load should be between 60 per cent and 160 per cent of the driven rear total axle load.
- The static tyre load on the same driven axle should not differ by more than 10 per cent.
- 4.7.4.2. The driven tyres inflation pressure shall be 70 per cent of the one written on the sidewall.
- The steer tyres are inflated at nominal sidewall pressure.
- If the pressure is not marked on the sidewall, refer to the specified pressure in applicable tyre standards manuals corresponding to maximum load capacity.

- 4.7.5. Testing runs
- 4.7.5.1. Mount first the set of reference tyres on the vehicle and when on the testing area.
- Drive the vehicle at a constant speed between 4 km/h and 11 km/h and the gear ratio capable of covering the speed range of at least 19 km/h for the complete test programme (e.g. R-T1-T2-T3-R).
- The recommended gear ratio selected is 3<sup>rd</sup> or 4<sup>th</sup> and shall give a minimum 10 per cent average slip ratio in the measured range of speed.
- 4.7.5.2. In case of traction control system equipped vehicles (already switched "on" before the run) apply full throttle until the vehicle has reached the final speed.
- Final speed = Initial speed + 15 km/h
- No rearward restraining force shall be applied to the test vehicle.
- 4.7.5.2.1. In the particular case of paragraph 4.7.2.1.1. of this annex where a standard commercial vehicle equipped with a traction control system is not available, the driver shall manually maintain the average slip ratio between 10 and 40 per cent (controlled slip procedure in place of the full slip) within the prescribed range of speeds. If a differential lock is not available, the averaged slip ratio difference between the left and right driven wheel shall not be higher than 8 per cent for each run. All the tyres and runs in the test session are performed with controlled slip procedure.
- 4.7.5.3. Measure the distance between the initial speed and the final speed.
- 4.7.5.4. For every candidate tyre and the standard reference tyre, the acceleration test runs shall be repeated a minimum of 6 times and the coefficients of variation (standard deviation/average\*100) calculated for minimum 6 valid runs on the distance shall be lower than or equal to 6 per cent.
- 4.7.5.5. In case of traction control system equipped vehicle, the average slip ratio shall be in the range from 10 per cent to 40 per cent (calculated as per paragraph 4.3.4. of this annex).
- 4.7.5.6. Apply testing sequence as defined in paragraph 4.6. above.
- 4.8. Processing of measurement results
- 4.8.1. Calculation of the average acceleration AA
- Each time the measurement is repeated, the average acceleration AA (m · s<sup>-2</sup>) is calculated by
- $$AA = \frac{S_f^2 - S_i^2}{2D}$$
- Where D (m) is the distance covered between the initial speed S<sub>i</sub> (m.s<sup>-1</sup>) and the final speed S<sub>f</sub> (m.s<sup>-1</sup>).

4.8.2. Validation of results

For the candidate tyres:

The coefficient of variation of the average acceleration is calculated for all the candidate tyres. If one coefficient of variation is greater than 6 per cent, discard the data for this candidate tyre and repeat the test.

$$\text{coefficient of variation} = \frac{\text{stdev}}{\text{average}} \times 100$$

For the reference tyre:

If the coefficient of variation of the average acceleration "AA" for each group of min 6 runs of the reference tyre is higher than 6 per cent, discard all data and repeat the test for all tyres (the candidate tyres and the reference tyre).

In addition and in order to take in account possible test evolution, the coefficient of validation is calculated on the basis of the average values of any two consecutive groups of min 6 runs of the reference tyre. If the coefficient of validation is greater than 6 per cent, discard the data for all the candidate tyres and repeat the test.

$$\text{coefficient of validation} = \left| \frac{\text{Average2} - \text{Average1}}{\text{Average1}} \right| \times 100$$

4.8.3. Calculation of the "average AA"

If  $R_1$  is the average of the "AA" values in the first test of the reference tyre,  $R_2$  is the average of the "AA" values in the second test of the reference tyre, the following operations are performed, according to Table 1:

Table 1

<i>If the number of sets of candidate tyres between two successive runs of the reference tyre is:</i>	<i>and the set of candidate tyres to be qualified is:</i>	<i>then "Ra" is calculated by applying the following:</i>
1   R - T1 - R	T1	$R_a = 1/2 (R_1 + R_2)$
2   R - T1 - T2 - R	T1	$R_a = 2/3 R_1 + 1/3 R_2$
	T2	$R_a = 1/3 R_1 + 2/3 R_2$
3   R - T1 - T2 - T3 - R	T1	$R_a = 3/4 R_1 + 1/4 R_2$
	T2	$R_a = 1/2 (R_1 + R_2)$
	T3	$R_a = 1/4 R_y + 3/4 R_y$

"T<sub>a</sub>" (a = 1, 2, ...) is the average of the AA values for a test of a candidate tyre.



4.8.4 "AFC" Calculation (Acceleration Force Coefficient)

Also called AFC Acceleration Force Coefficient

Calculation on of AFC(T<sub>a</sub>) and AFC(R<sub>a</sub>) as defined in Table 2 :

Table 2

	<i>The acceleration force coefficient "AFC" is:</i>
Reference tyre	$AFC(R) = \frac{R_a}{g}$
Candidate tyre	$AFC(T) = \frac{T_a}{g}$

*R<sub>a</sub> and T<sub>a</sub> are in m/s<sup>2</sup>*

*"g"= gravity acceleration (rounded to 9.81 m/s<sup>2</sup>)*

4.8.5. Calculation of the relative snow grip index of the tyre

The snow grip index represents the relative performance of the candidate tyre compared to the reference tyre.

$$\text{Snow Grip Index} = \frac{AFC(T)}{AFC(R)}$$

4.8.6. Calculation of the slip ratio

The slip ratio can be calculated as the average of slip ratio as mentioned in paragraph 4.3.4. of this annex or by comparing the average distance referred to in paragraph 4.7.5.3. of this annex of the minimum 6 runs to the distance of a run done without slip (very low acceleration)

$$\text{Slip Ratio \%} = \left[ \frac{\text{Average distance} - \text{No slip distance}}{\text{No slip distance}} \right] \times 100$$

No slip distance means the wheel distance calculated on a run done with a constant speed or a continuous low acceleration.

4.9. Snow grip performance comparison between a candidate tyre and a reference tyre using a control tyre

4.9.1. Scope

When the candidate tyre size is significantly different from the reference tyre a direct comparison on the same vehicle may be not possible. This is an approach using an intermediate tyre, hereinafter called the control tyre.

4.9.2. Principle of the approach

The principle lies upon the use of a control tyre and 2 different vehicles for the assessment of a candidate tyre in comparison with a reference tyre.

One vehicle can fit the reference tyre and the control tyre, the other the control tyre and the candidate tyre. All conditions are in conformity with paragraph 4.7. above .

The first assessment is a comparison between the control tyre and the reference tyre. The result (snow Grip Index 1) is the relative efficiency of the control tyre compared to the reference tyre.

The second assessment is a comparison between the candidate tyre and the control tyre. The result (snow grip index 2) is the relative efficiency of the candidate tyre compared to the control tyre.

The second assessment is done on the same track as the first one. The air temperature must be in the range of +/- 5 deg C of the temperature of the first assessment. The control tyre set is the same set as the set used for the first assessment.

The snow grip performance index of the candidate tyre compared to the reference tyre is deduced by multiplying the relative efficiencies calculated above:

$$\text{Snow Grip Index} = \text{SG1} \times \text{SG2}$$

4.9.3. Selection of a set of tyres as a control tyre set

A control tyre set is a group of identical tyres made in the same factory during one week period.

4.10. Storage and preservation

Before the first assessment (control tyre / reference tyre), normal storage conditions can be used. It is necessary that all the tyres of a control tyre set have been stored in the same conditions.

As soon as the control tyre set has been assessed in comparison with the reference tyre, specific storage conditions shall be applied for control tyres replacement.

When irregular wear or damage results from tests, or when wear influences the test results, the use of the tyre shall be discontinued.

## Annex 7 - Appendix 1

### Pictogram definition of "Alpine Symbol"



Minimum 15 mm base and 15 mm height.

Above drawing not to scale.

## Annex 7 - Appendix 2

### Test reports and test data for C1 and C2 tyres

#### Part 1 - Report

1. Type Approval Authority or Technical Service: .....
2. Name and address of applicant: .....
3. Test report No.: .....
4. Manufacturer and brand name or trade description: .....
5. Tyre class: .....
6. Category of use: .....
7. Snow index relative to SRTT according to paragraph 6.4.1.1.
- 7.1. Test procedure and SRTT used .....
8. Comments (if any): .....
9. Date: .....
10. Signature: .....

#### Part 2 - Test data

1. Date of test: .....
2. Location of test track: .....
- 2.1. Test track characteristics:

	<i>At start of tests</i>	<i>At end of tests</i>	<i>Specification</i>
Weather			
Ambient temperature			-2 °C to -15 °C
Snow temperature			-4 °C to -15 °C
CTI index			75 to 85
Other			

3. Test vehicle (make, model and type, year): .....
4. Test tyre details.....
- 4.1. Tyre size designation and service description: .....
- 4.2. Tyre brand and trade description: .....
- 4.3. Test tyre data: .....

	<i>SRTT</i> (1st test)	<i>Candidate</i>	<i>Candidate</i>	<i>SRTT</i> (2nd test)
Tyre dimensions				
Test rim width code				
Tyre loads F/R (kg)				
Load index F/R ( per cent)				
Tyre pressure F/R(kPa)				

5. Test results: mean fully developed decelerations (m/s<sup>2</sup>) / traction coefficient<sup>1</sup>

<i>Run number</i>	<i>Specification</i>	<i>SRTT</i> (1st test)	<i>Candidate</i>	<i>Candidate</i>	<i>SRTT</i> (2nd test)
1					
2					
3					
4					
5					
6					
Mean					
Std-deviation					
CV (%)	< 6 %				
Validation SRTT	(SRTT) < 5 %	X	X	X	
SRTT average		X	X	X	X
Snow grip index		100			X

<sup>1</sup> Strike out what does not apply.

## Annex 7 - Appendix 3

### Test reports and test data for C3 tyres

#### Part 1 - Report

1. Type Approval Authority or Technical Service: .....
2. Name and address of applicant: .....
3. Test report No.: .....
4. Manufacturer and brand name or trade description: .....
5. Tyre class: .....
6. Category of use: .....
7. Snow grip index relative to SRTT according to paragraph 6.4.1.1.
- 7.1. Test procedure and SRTT used .....
8. Comments (if any): .....
9. Date: .....
10. Signature: .....

#### Part 2 - Test data

1. Date of test: .....
2. Location of test track: .....
- 2.1. Test track characteristics:

	<i>At start of tests</i>	<i>At end of tests</i>	<i>Specification</i>
Weather			
Ambient temperature			-2 °C to -15 °C
Snow temperature			-4 °C to -15 °C
CTI index			80 to 90
Other			

3. Test vehicle (make, model and type, year): .....
4. Test tyre details .....
- 4.1. Tyre size designation and service description: .....
- 4.2. Tyre brand and trade description: .....
- 4.3. Test tyre data: .....

	<i>SRTT (1st test)</i>	<i>Candidate 1</i>	<i>Candidate 2</i>	<i>Candidate 3</i>	<i>SRTT (2nd test)</i>
Tyre dimensions					
Test rim width code					
Tyre loads F/R (kg)					
Load index F/R (per cent)					
Tyre pressure F/R (kPa)					

5. Test results: average accelerations (m/s<sup>2</sup>)

<i>Run number</i>	<i>Specification</i>	<i>SRTT (1st test)</i>	<i>Candidate 1</i>	<i>Candidate 2</i>	<i>Candidate 3</i>	<i>SRTT (2nd test)</i>
1						
2						
3						
4						
5						
6						
Mean						
Std-deviation						
Slip ratio (per cent)						
CV (per cent)	≤ 6 per cent					
Validation SRTT	(SRTT) ≤ 6 per cent	X	X	X	X	
SRTT average			X	X	X	X
Snow index		1.00				X