

INSTALLATION INSTRUCTIONS

SKINS WALLPAPER

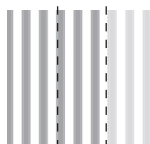
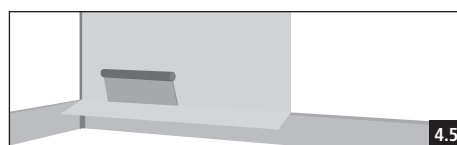
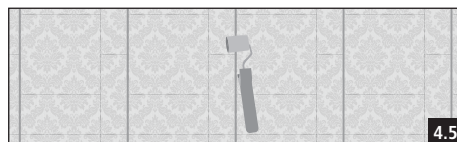
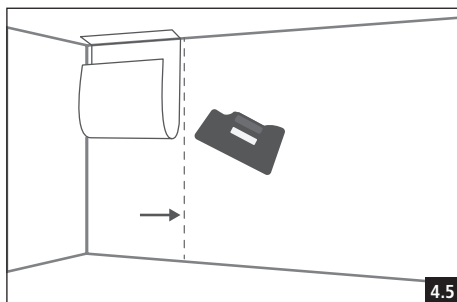
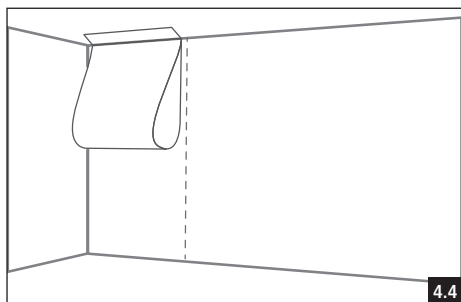
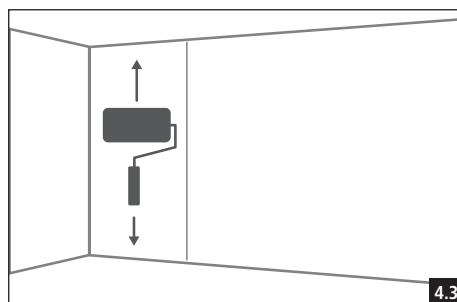
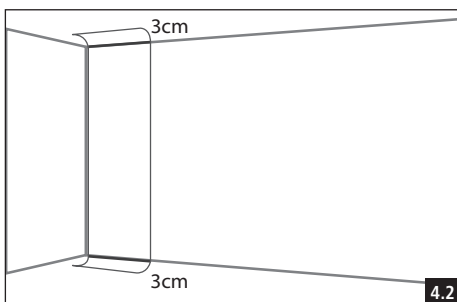
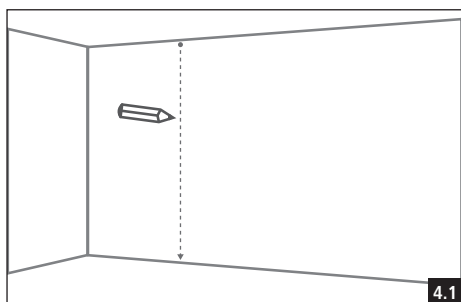

**RANDOM MATCH**

There is no need to follow an installation pattern, the drop always matches the previously installed roll.

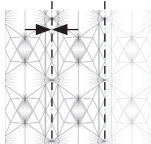

**STRAIGHT MATCH**

The installation must be carried out in mirror mode, i.e. the end of the previous roll must always coincide with the beginning of the next roll to be installed.

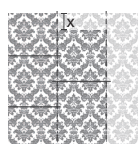

**DROP MATCH**

The distance/drop in centimeters, indicated by the design, must be left during installation. E.g.: x = 26.5 cm.

**I. BEFORE INSTALLATION**

The information given in these installation instructions follows general standards. All instructions and advice must be followed to ensure a correct and satisfactory installation. The wallpaper coating of the SKINS series must be stored and installed indoors. It is suitable for walls that are not in direct contact with water in kitchens and bathrooms. It is the responsibility of the installer/owner to carefully inspect the material for defects prior to installation. The warranty does not cover materials installed with visible defects. If you are not satisfied with the material prior to installation, contact your dealer. **DO NOT INSTALL.** We recommend that you, as the final inspector, examine the material supplied to match the material ordered, color, design and finish, **BEFORE** installation. We recommend that you purchase all the wallpaper you will need in the same order and production shade, as there will be slight shade changes between different dyes/batches. Check that the material is correct. We will not be responsible for any costs incurred once the piece with visible defects is installed. It is the responsibility of the installer and the owner to ensure that job site and work area conditions are acceptable prior to installation of the material. To achieve a balance between a wallpaper of the quality of the SKINS collection, and a satisfactory finish, it is recommended that the installation be carried out by an experienced professional. Installation of the material constitutes acceptance of the lot.

**II. SUBSTRATE REQUIREMENTS**

In order to achieve the best results, it is important that the substrate on which the wallpaper roll is to be installed is properly prepared. Check that the substrate is smooth (no holes, cracks, irregularities...), dry, clean, solid and has adequate absorption. Remove the old paper if there is any. The color of the wall must be uniform and light-colored.

**III. CALCULATION OF ROLLS NEEDED**

The following is an example of how to calculate the number of rolls needed, assuming a wall 12 meters long and 2.20 meters high, for a model with 26,5 cm match.

1. Calculate how many whole strips you will be able to lay with each roll: divide (the length of the roll + 6 cm + match) by the height of the wall.

Roll length = 10.05 m (32 ft 11 5/8 in)

Wall height + 6 cm + match = 2.20 + 0.06 + 0.265 = 2.525 m (8 ft 3 3/8 in)

Complete strips = 10,05 / 2,525 = 3.98 (13 ft 3/4 in)

You can lay 3 whole strips with each roll.

2. Calculate the strips needed: divide the width of the wall (in meters) by 0.53m.

Assuming width=12 m

Strips needed = 12 m / 0,53 m = you need 23 whole strips to cover the wall

3. Calculate the rolls needed: divide the strips needed by the whole strips that come out of a roll

23 / 3 = 7.66 \_ you need 8 rolls

Please note that the doors and windows area will have to be subtracted. If the result of the calculation is too tight, we recommend purchasing one more roll.

You can also make your own calculation with the roll calculator that you will find on our web site [www.anticcolonial.com](http://www.anticcolonial.com).

**IV. INSTALLATION**

Tools needed: large scissors, cutter, plumb or level, metal ruler, pencil, brush, roller, wallpaper brush or rubber spatula, sponge, clean rag, measure tape, corner roller, rubber joint roller, ladder.

For an aesthetically satisfactory finish, make a laying plan before starting, place whole pieces in the most prominent areas of the room, and continue installing to the right and left of that point, so that the design is centered and symmetrical, leaving the cuts for the areas that are more concealed.

4.1. Using a plumb or level, draw a line on the wall that will serve as a reference to indicate the right end of the roll, with the corner of the wall being the reference for the other end.

4.2. Open the roll, and make sure it is laid out in the right direction. Measure the height of the wall and cut the roll by adding 6 cm (3 cm more at the top and 3 cm more at the bottom).

For the side continuity of the following rolls, take into account the type of matching. The matching marks the distance in which the pattern is repeated along a roll of wallpaper. Therefore, you need to take this measurement into account for the installation of designs that feature both straight and skipped matchings.

During installation, so that the pattern is not mismatched between the strips, there is a waste equivalent to the size of the matching. Therefore, to calculate the number of rolls that will be needed, you must take into account these measurements.

4.3. Apply the glue with a roller directly on the wall, at least 10 cm wider than the width of the paper to be glued. Use a brush to apply the glue in corners, near frames, and difficult areas, and use

the roller for large areas. It is easy to identify the area where the glue has been applied thanks to the pink color of the SKINS FIX glue, the glue becomes transparent once dry. After applying the adhesive, apply the wallpaper within 30 minutes. Clean the tool with lukewarm water immediately after use.

L'Antic Colonial recommends using Butech's SKINS FIX glue for proper application. Check that the application temperature is between + 10°C and + 25°C. Follow the instructions of the glue manufacturer, for more information consult [www.butech.net](http://www.butech.net).

4.4. Roll the strip upside down without making folds that could cause wrinkles. Start laying by fixing the upper part, leaving 3 cm above, which will later be trimmed, and respecting the reference line drawn with the plumb line or level. Do not overlap strips on top of each other.

4.5. Gently press the upper half of the paper strip using a wallpaper brush or rubber spatula, without losing sight of the reference line. Proceed in the same manner, spreading the lower half of the roll. To avoid bubbles, pressure should be applied from top to bottom and from the center to the ends. Press the paper against the ceiling and against the skirting board with a ruler or rubber spatula.

Before drying, wipe the joints with a dry cloth to ensure proper adhesion.

To ensure proper adhesion at the joints between rolls, press along the strips using a rubber joint roller.

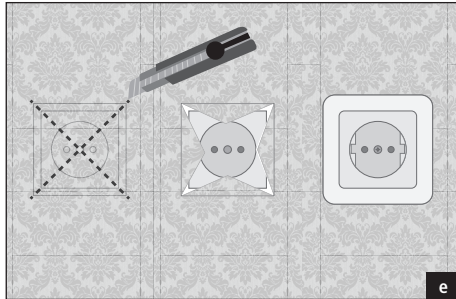
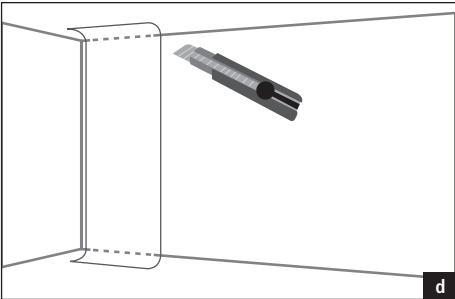
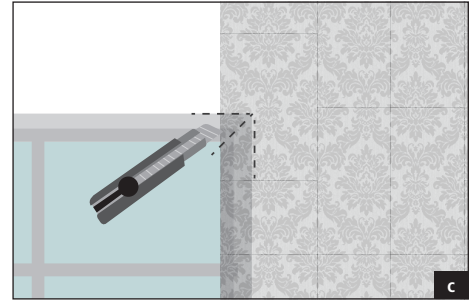
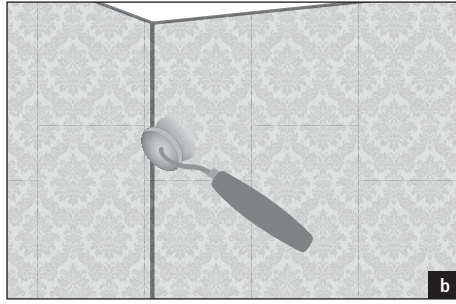
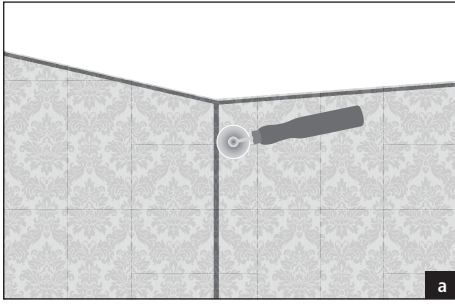

#### V. INSTALLATION TIPS

Here are some installation tips to solve some of the most common areas that can be found in a room:

**a.** In inside corners, make sure there are no imperfections or irregularities, continue laying the roll, and use a corner roller to achieve a perfect adherence.

**b.** Outside corners. To avoid imperfections in the finish of the corners, make sure that there are no bumps or irregularities. Adhere the roll along the corner, and make sure that the cut does not end at the edge, occupy a minimum distance of 5 cm from the next wall. Use a corner roller to achieve a satisfactory adhesion.

**c.** Junctions with door and window frames. In the junction with window and door frames, place the paper strip and overlap 5-10 cm above the frame. Make a diagonal cut from the corner.

Adjust the paper to the edge of the window frame, pressing with a metal ruler against the frame, as you did against the skirtings, and trim the excess with a metal ruler and a knife, when the glue is dry.

**d.** Before it dries, wipe off the glue excess with a damp rag or damp sponge, wipe the sponge or rag constantly, always using clean water. Once completely dry, trim the upper and lower excess.

**e.** To fix finishes on recessed elements such as electrical sockets or switches:

- disconnect the power supply
- dismantle the trim
- cut the paper crosswise
- fold the 4 pieces outwards, and finish by trimming the excess and replacing the trim.

#### MAINTENANCE AND CLEANING

The SKINS wallpaper collection stands out for its quality and resistance. Wallpaper as a decorative element does not get dirty easily with regular use, however, it requires minimal maintenance and cleaning.

For ordinary maintenance it is recommended to use a feather duster, or a soft dry cloth.

SKINS wallpaper can be easily cleaned with a sponge lightly dampened with water. Rub gently, avoiding the paper to get wet, then wipe with a dry cloth.

Despite the resistance of SKINS wallpaper in normal use, it can be affected by the action of more aggressive agents and accidental stains since prolonged exposure to certain chemicals and substances can irreparably alter its appearance. To try to minimize as much as possible the action of these agents in the event that your wallpaper suffers a stain:

- clean as soon as possible, use a dry cloth first to absorb it and avoid spreading it.
- then proceed with a slightly damp sponge with soap and water.
- rub delicately.
- finish by drying with a soft cloth.

Good prevention is essential when there is a risk of staining; avoid these situations as much as possible, as there are stains that can leave permanent marks after cleaning.

Never use aggressive products (bleach, ammonia, all-purpose cleaners...), or overly abrasive sponges or scouring pads, as they can permanently damage the paper.

Uninstallation: this type of NWT (non-woven) paper allows the task of removing the paper by simply pulling from the bottom, dry, which is a quick, clean, and easy way to carry out the uninstallation.

L'ANTIC COLONIAL, S.A., WILL NOT BE HELD RESPONSIBLE FOR ANY SPECIAL, INCIDENTAL, INDIRECT OR CONSEQUENTIAL DAMAGES, AMONG OTHERS: LOSS OF PROFIT, REVENUE, OR INFORMATION (WHETHER DIRECT OR INDIRECT) OR LOSS OF BUSINESS FOR BREACH OF ANY EXPRESS OR IMPLIED WARRANTY OF ITS PRODUCT, EVEN IF L'ANTIC COLONIAL, S.A., HAS BEEN PREVIOUSLY ADVISED OF THE POSSIBILITY OF SUCH DAMAGES. Some local jurisdictions do not allow the exclusion or limitation of special, indirect, incidental, or consequential damages, so this limitation or exclusion may not apply to you.

EXCEPT WHERE PROHIBITED BY APPLICABLE LAW, ANY IMPLIED WARRANTY OR CONDITION OF MERCHANTABILITY OR FITNESS FOR A PARTICULAR PURPOSE WITH RESPECT TO THIS PRODUCT IS EXPRESSLY EXCLUDED. Some local laws do not allow limitations on how long an implied warranty lasts, so this limitation may not apply to your jurisdiction.

#### PROCESSING OF A WARRANTY CASE:

If you wish to validate this warranty, be sure to follow the steps below:

-Verify that you have complied with all the steps and requirements established in the installation, use and maintenance manuals of L'Antic Colonial, S.A.

-Report in writing to the authorized dealer/seller or directly to the company L'Antic Colonial S.A., Crta. Nacional 340, km 54, 12540 Villarreal, Castellón, Spain within 30 days of the occurrence of the damage or defects.

The warranty does not affect the legal rights of the consumer and user in the event of non-conformity of the products with the contract. The action to claim compliance with the provisions of the additional commercial warranty shall lapse six months after the end of the warranty period.