

**ASSEMBLY INSTRUCTIONS**  
*INSTRUCTIONS DE MONTAGE*  
**INSTRUCCIONES DE ENSAMBLAJE**

**1938**  
**Xpressions™**  
**47" Desk**  
*119 cm Bureau*  
**47" Escritorio**

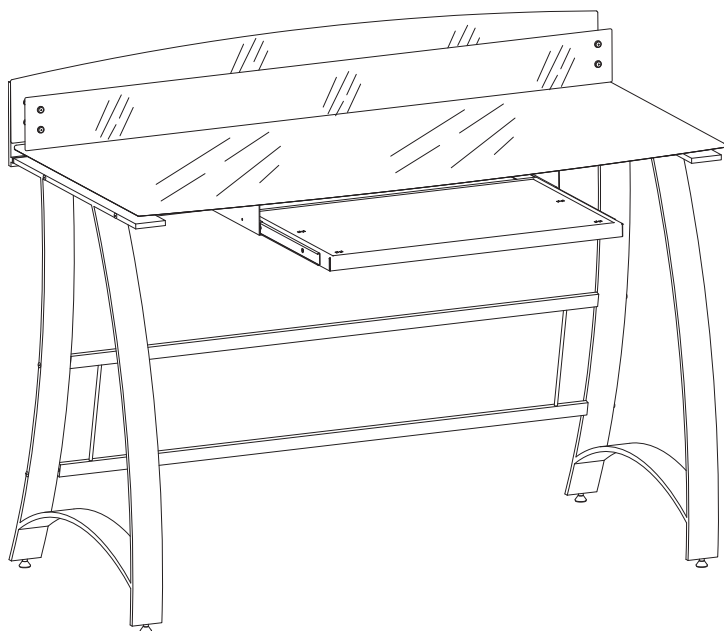
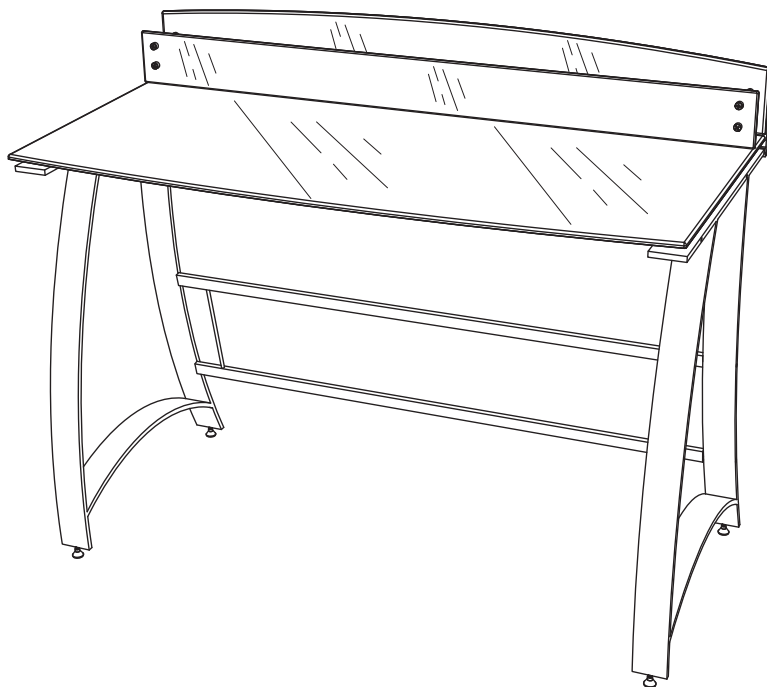

**SHOWN WITH KEYBOARD TRAY, SOLD SEPARATELY**

*Montré avec le support de clavier, vendu séparément*

Se muestra con bandeja del teclado, se vende por separado

**PRODUCT WARRANTY** is available online at: [www.safcoproducts.com](http://www.safcoproducts.com)

• LA GARANTIE DU PRODUIT est  
disponible sur l'Internet : [www.safcoproducts.com](http://www.safcoproducts.com)

• LA GARANTÍA DEL PRODUCTO está  
disponible en la Internet: [www.safcoproducts.com](http://www.safcoproducts.com)

For questions or concerns, please call **1-800-664-0042**  
available Monday-Friday 7:30 AM to 5:00 PM (Central Time) (English-speaking operators)









Si vous avez des questions pour poser ou les préoccupations  
pour exprimer, connecter **au 1-800-664-0042**  
de 7H30 à 17H00 (Heure centrale) (Opérateurs de langue anglaise)

Si usted tiene preguntas o preocupaciones,  
por favor llame **1-800-664-0042**  
de 7:30 AM a 5:00 PM (Hora Central) (Operadores que hablan inglés)

**TOOLS REQUIRED:** Allen Wrench (included)

Parts List			
Code	DESCRIPTION	Qty.	Part No.
(A)	Leg	1	100193601
(B)	Desk support, back	1	100193802
(C)	Desktop support, long	2	100193803
(D)	Small glass shelf	1	100193804
(E)	Big glass shelf	1	100193805
(F)	Glass desktop	1	100193806
(G)	Back splash support	1	100193807









Two People Recommended.

Hardware Pack 1938-19NC		
<b>H</b>  Big Screw Qty. 12 100193622	<b>I</b>  Screw Qty. 4 100193624	<b>J</b>  Spacer Qty. 4 100193826
<b>K</b>  Rubber Washer Qty. 12 100193823	<b>L</b>  Leveller Qty. 4 100193625	<b>M</b>  Allen Wrench (not shown) Qty. 1 100193627
<b>N</b>  Small Screw Qty. 4 100194022	<b>O</b>  Open-End Wrench (not shown) Qty. 1 100193628	

**OUTILS REQUIS :** Clef Allen (incluse)

Liste des Pièces			
Code	DESCRIPTION	Qté	N° de Pièce
(A)	Jambe	1	100193601
(B)	Barre inférieure pour le bureau	1	100193802
(C)	Barre supérieure pour le bureau, à long	2	100193803
(D)	Petite panneau en verre	1	100193804
(E)	Panneau en verre grand	1	100193805
(F)	Bureau en verre	1	100193806
(G)	Support pour panneau arrière	1	100193807







On recommande que l'assemblage soit effectué par deux personnes.

Paquet Matériel 1938-19NC		
<b>H</b>  Grand Vis Qté. 12 100193622	<b>I</b>  Vis Qté. 4 100193624	<b>J</b>  Espacement tube Qté. 4 100193826
<b>K</b>  Rondelle en caoutchouc Qté. 12 100193823	<b>L</b>  Pied Qté. 4 100193625	<b>M</b>  Clé Allen (non représenté) Qté. 1 100193627
<b>N</b>  Petit vis Qté. 4 100193624	<b>O</b>  Clé à fourche (non représenté) Qté. 1 100193628	

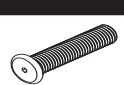
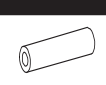
**HERRAMIENTAS REQUERIDAS:** Llave Allen (incluida)

Lista de Piezas			
Código	DESCRIPCIÓN	Cant.	No. de Pieza
(A)	Pierna	1	100193601
(B)	Barra inferior del escritorio	1	100193802
(C)	Soporte de escritorio, a largo	2	100193803
(D)	Panel de vidrio pequeño	1	100193804
(E)	Panel de vidrio grande	1	100193805
(F)	Vidrio de escritorio	1	100193806
(G)	Soporte para parte posterior panel	1	100193807

Se recomienda dos personas para el ensamblaje.

Paquete Material: 1938-19NC		
<b>H</b>  Tornillo Grandes Cant. 12 100193622	<b>I</b>  Tornillo Cant. 4 100193624	<b>J</b>  Tubo espaciamento Cant. 4 100193826
<b>K</b>  Arandela de goma Cant. 12 100193823	<b>L</b>  Nivelador Cant. 4 100193625	<b>M</b>  Llave Allen (no se muestra) Cant. 1 100193627
<b>N</b>  Tornillo pequeño Cant. 4 100193624	<b>O</b>  Llave de boca (no se muestra) Cant. 1 100193628	

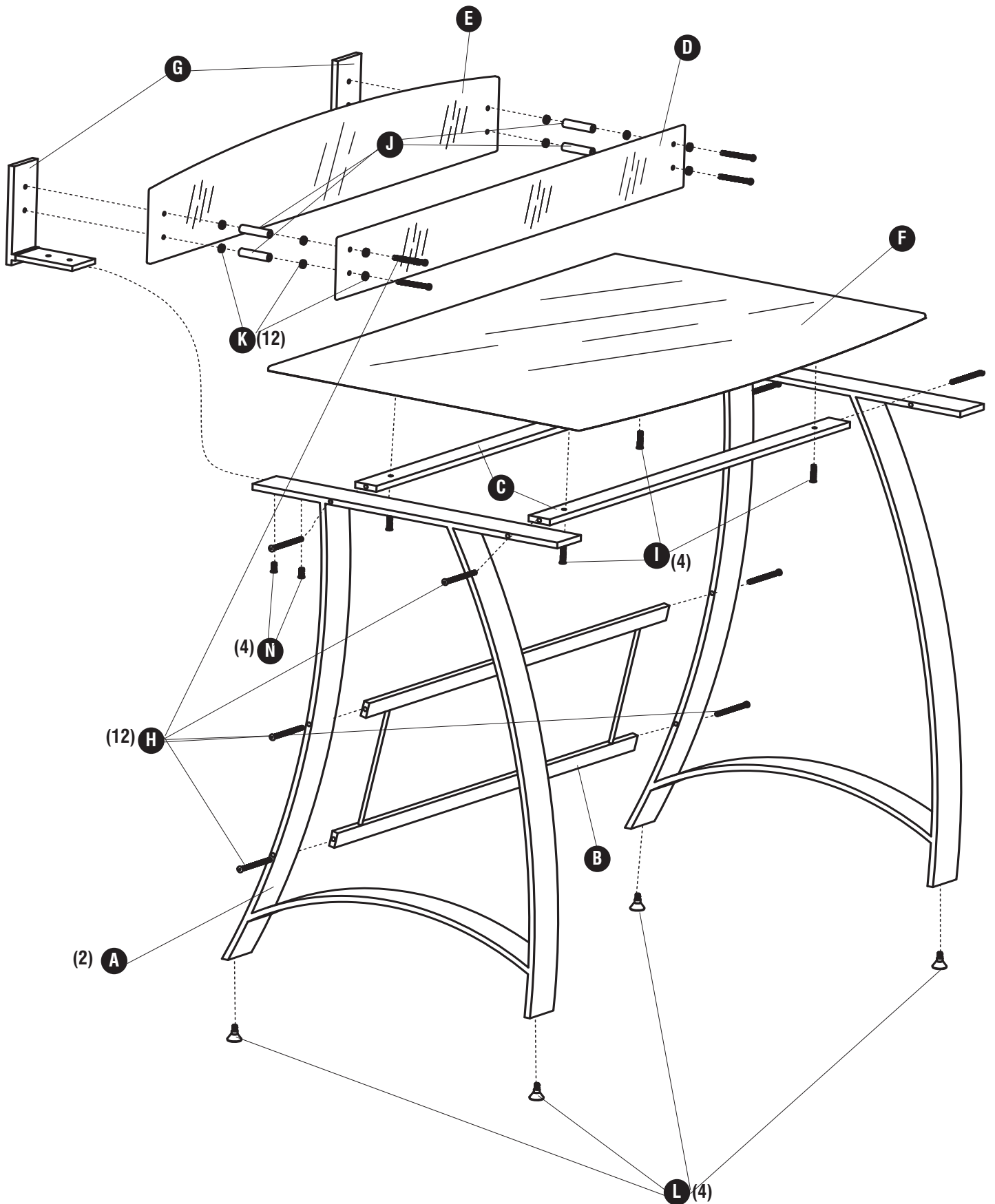

1



**IMPORTANT: Do not tighten the screws until all parts are in place.**

Important: Ne pas serrer les vis jusqu'à ce que toutes les pièces sont en place.

¡¡IMPORTANTE! No apriete los tornillos hasta que todas las piezas estén en su lugar.

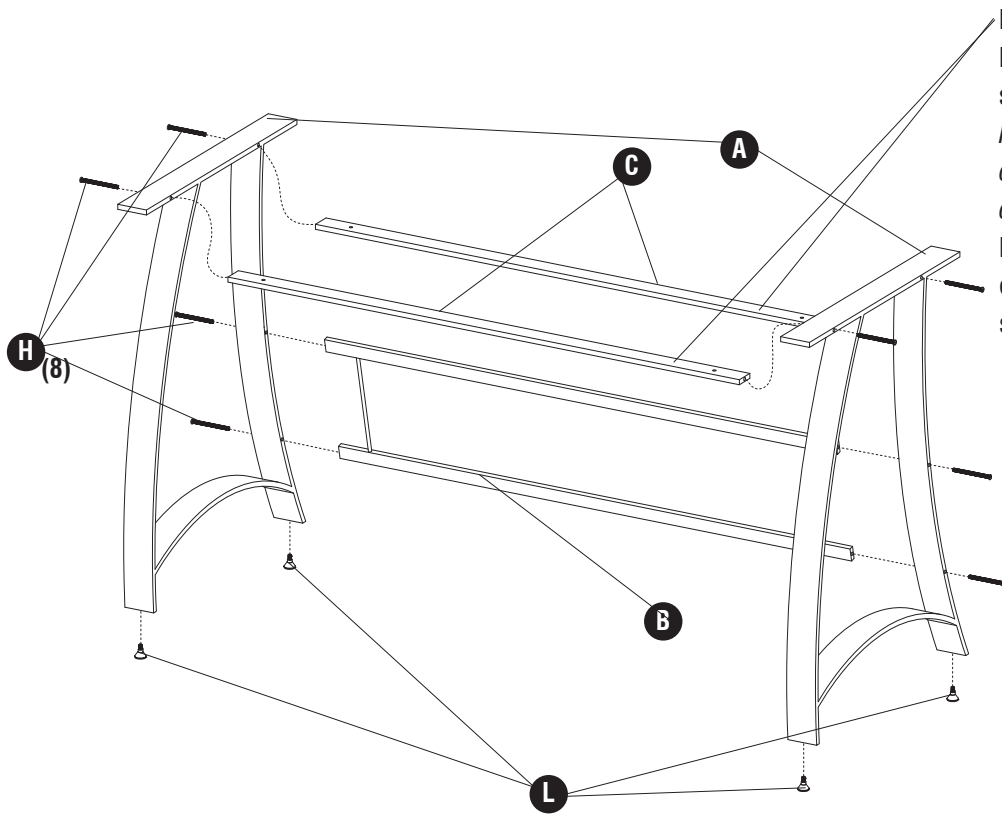

**NOTE: The holes to attach the optional Keyboard Tray (sold separately) should be facing the bottom.**

*REMARQUE: Les trous pour fixer le plateau de clavier en option (vendu séparément) doit être orientée vers le bas.*

*NOTA: Los orificios para fijar la bandeja del teclado opcional (se vende por separado) debe estar hacia la parte inferior.*

2

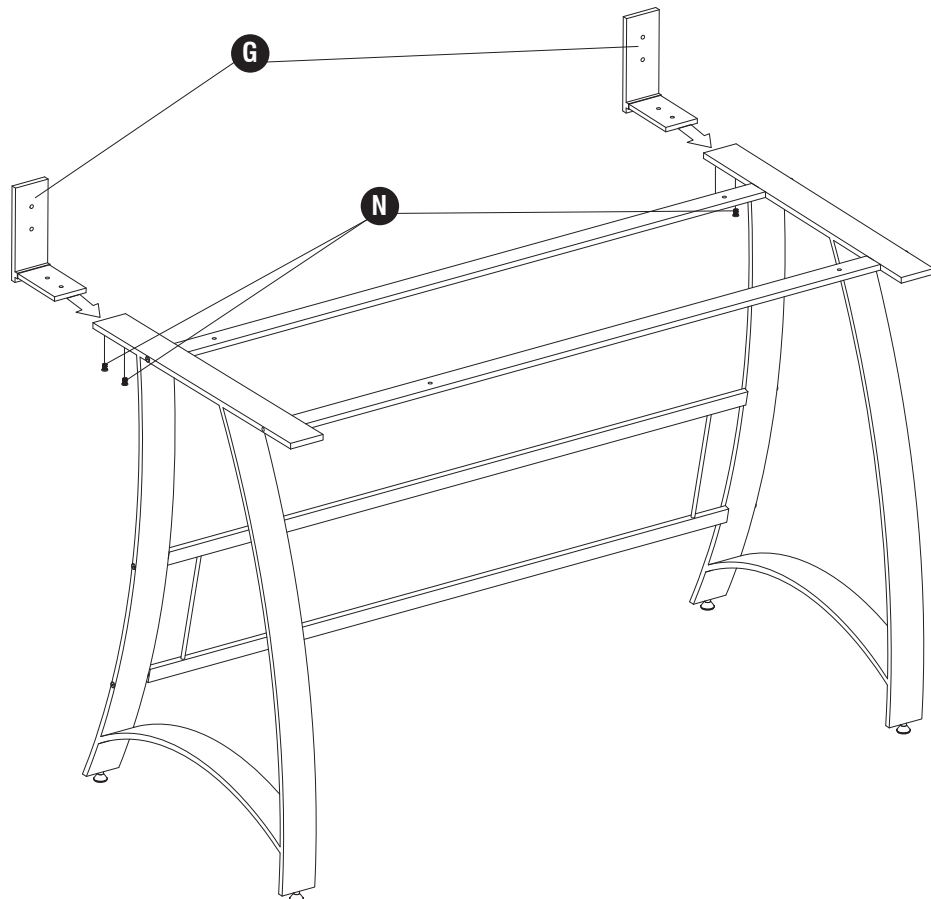
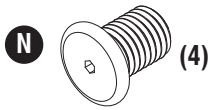

3

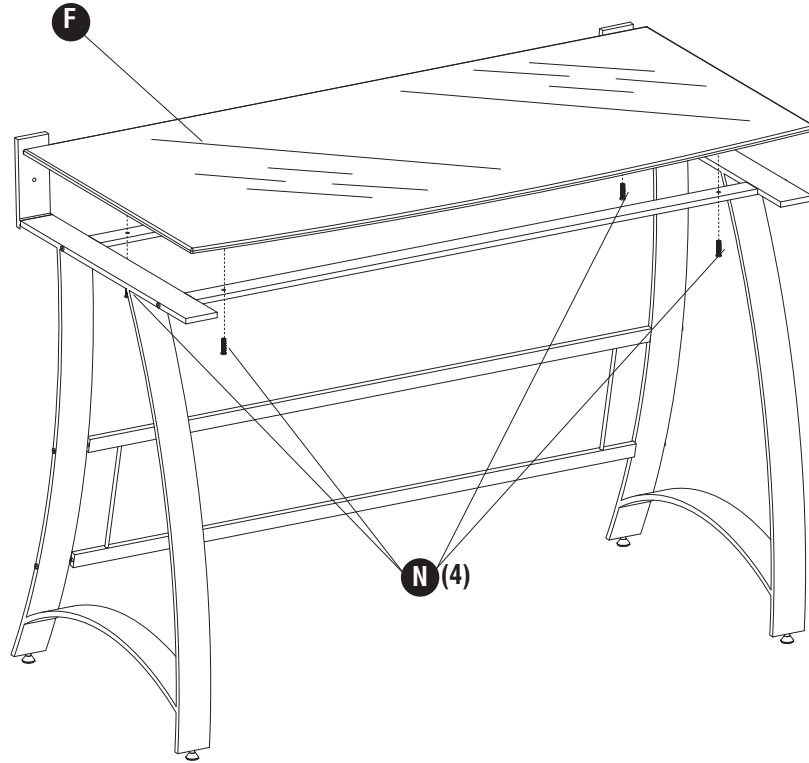
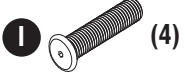

4

K

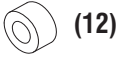

J



H

