

---

**4215**  
**Costumer 6 Hook Coat Rack**  
*Costumier 6 Crochet Porte-Manteau*  
Cliente 6 Gancho Perchero

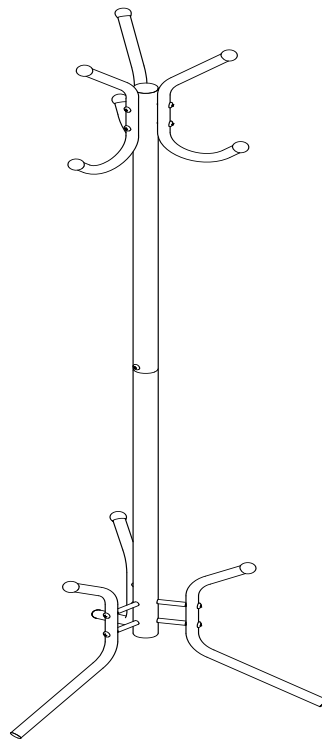

---

**PRODUCT WARRANTY** is available online at: [www.safcoproducts.com](http://www.safcoproducts.com)

• LA GARANTIE DU PRODUIT est  
disponible sur l'Internet : [www.safcoproducts.com](http://www.safcoproducts.com)

• LA GARANTÍA DEL PRODUCTO está  
disponible en la Internet: [www.safcoproducts.com](http://www.safcoproducts.com)

---

For questions or concerns, please call **1-800-664-0042**  
available Monday-Friday 7:30 AM to 5:00 PM (Central Time) (English-speaking operators)



Si vous avez des questions pour poser ou les préoccupations  
pour exprimer, connecter **au 1-800-664-0042**  
de 7H30 à 17H00 (Heure centrale) (Opérateurs de langue anglaise)

Si usted tiene preguntas o preocupaciones,  
por favor llame **1-800-664-0042**  
de 7:30 AM a 5:00 PM (Hora Central) (Operadores que hablan inglés)

**PARTS LIST / LISTE DES PIÈCES / LISTA DE PIEZAS**

CODE / CODIGO	DESCRIPTION / DESCRIPTION / DESCRIPCIÓN	QTY. / QUANTITÉ / CANTIDAD	PART NO. / N° DE PIECE / NO. DE PIEZA
(A)	<b>Center Pole Top</b> / <i>Perche De Centre, Supérieur</i> / Polo Centro, Superior	1	100421502
(B)	<b>Center Pole Bottom</b> / <i>Perche De Centre, Inférieur</i> / Polo Centro, Baje	1	100421501
(C)	<b>Hook</b> / <i>Crochet</i> / Gancho	3	100421504
(D)	<b>Leg</b> / <i>Jambe</i> / Pierna	3	100421503

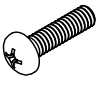
**HARDWARE PACK / PAQUET MATERIEL / PAQUETE MATERIAL  
90000052**

<b>E</b> 	<b>F</b> 	<b>G</b> 
<b>Spacer</b> <i>L'entretoise</i> Espaciador <b>Qty. / Qte. / Cant.: 6</b> #920000117	<b>Screw M6X28mm</b> <i>Vis M6X80mm</i> Tornillo M6X80mm <b>Qty. / Qte. / Cant.: 7</b> #905000132	<b>Screw M6X90mm</b> <i>Vis M6X89mm</i> Tornillo M6X89mm <b>Qty. / Qte. / Cant.: 6</b> #905000130

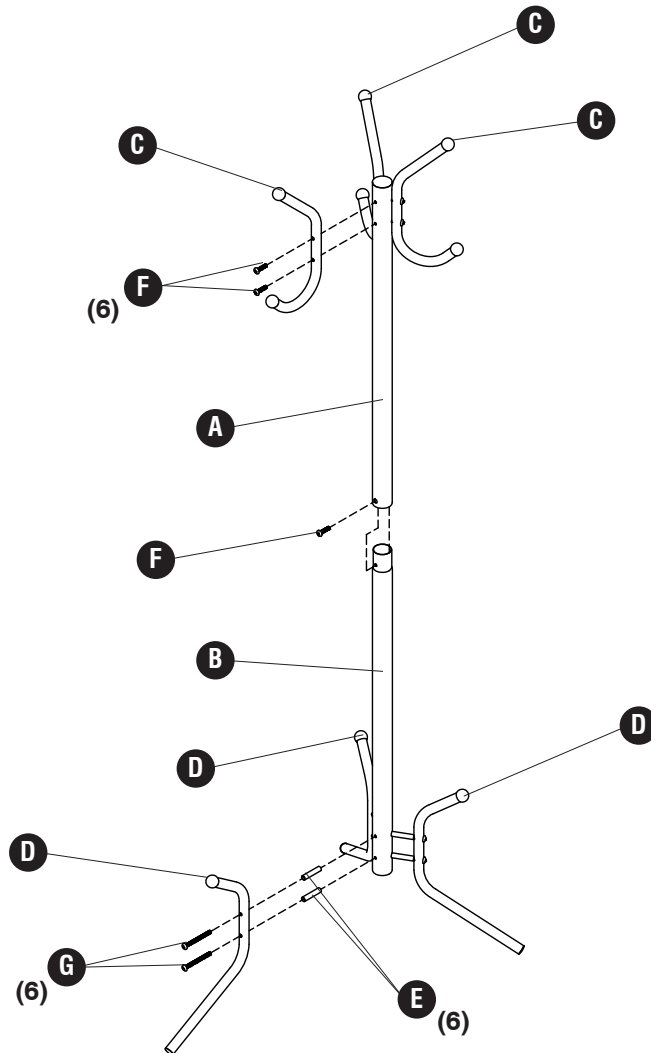

1

3X

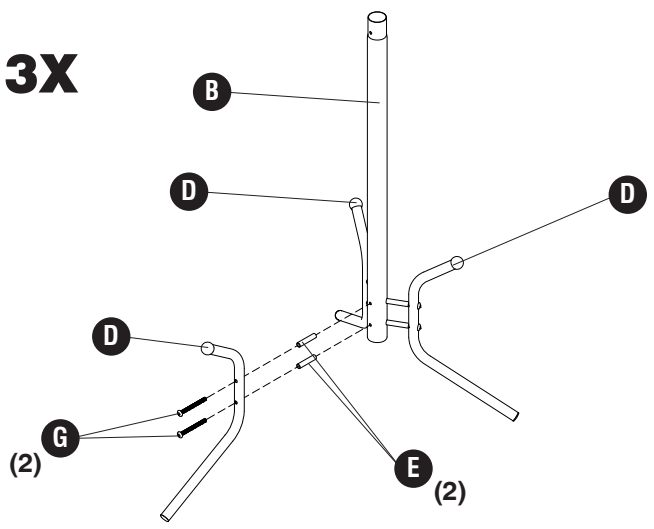

2

3X

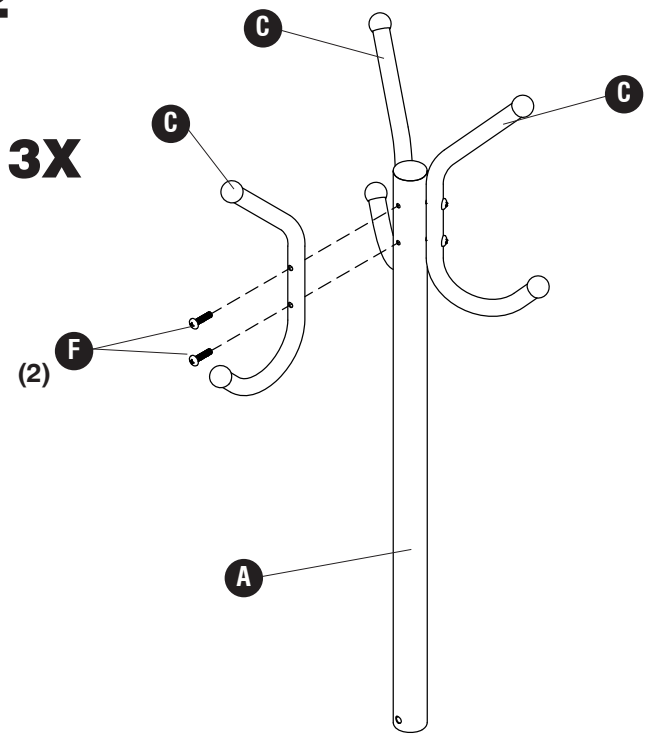

3

