



















Specifications (Series luminaires)

	Electrical isolation	CII
	Voltage (V)	100-250V
Hz	Frecuency (Hz)	50-60Hz
	Power factor (Cos fi)	≥0,5
	Dimming	No
	IP Tightness index	IP20
	Body color	White
	Diffuser Material	PC-T
	Body	AL
K	Colour temperature	3.000K
	CRI Colour rendering index	≥80
	Opening angle	45°
	Measures	Ø94x31mm
	Mounting position	Empotrado Techo
	Inclination	25°
	Operating temperature	-5 +35
	Flux (lm)	493lm
	Lifetime	(L70B50>) 50.000h

References 

	W	ϕ_{LUM}	K					
171007	6,5W	493lm	3.000K	≥80	White	Ø75-80	Ø94x31mm	No

Dimensions 

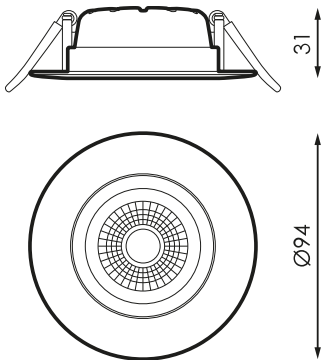

Photometry 

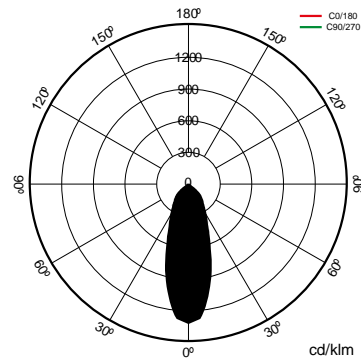

On request



Emergency kit 1h



Dali

Solutions

S



BLUETOOTH Pack

description



Device that enables DALI luminaire control through any Bluetooth® terminal via free APP that offers us control of flow regulation, color, scene configuration, behavior linked to schedules.

Info



For more information on the different solutions compatible with this luminaire, consult the following BIDI codes or on the web www.prilux.es

Info 

DIMMABLE NAVI serial: Suitable for conventional incandescent regulator/TRIAC. Tilt head.