

















### Specifications (Series luminaires)

	<b>Electrical isolation</b>	CII
	<b>Voltage (V)</b>	180-250V
<b>Hz</b>	<b>Frecuency (Hz)</b>	50-60Hz
	<b>Power factor (Cos fi)</b>	≥0,5
	<b>Dimming</b>	Yes
	<b>IP Tightness index</b>	IP20
	<b>Body color</b>	White
	<b>Body</b>	AL
<b>K</b>	<b>Colour temperature</b>	4.000K
	<b>CRI Colour rendering index</b>	≥80
	<b>Opening angle</b>	45°
	<b>Measures</b>	Ø94x31mm
	<b>Mounting position</b>	Empotrado Techo
	<b>Inclination</b>	25°
	<b>Operating temperature</b>	-5 +35
	<b>Flux (lm)</b>	498lm
	<b>Lifetime</b>	(L70B50>) 50.000h

References 

	W	$\phi_{LUM}$	K					
171038	6,5W	498lm	4.000K	≥80	White	Ø75-80	Ø94x31mm	Yes

Dimensions 

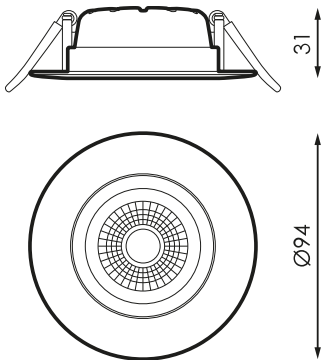

Photometry 

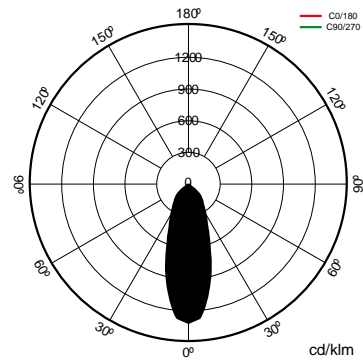

---

On request

---



Emergency kit 1h



Dali

---

Solutions

---

S



## BLUETOOTH Pack

---

description 

---

Device that enables DALI luminaire control through any Bluetooth® terminal via free APP that offers us control of flow regulation, color, scene configuration, behavior linked to schedules.

---

---

Info 

---

For more information on the different solutions compatible with this luminaire, consult the following BIDI codes or on the web [www.prilux.es](http://www.prilux.es)

**Info** 

DIMMABLE NAVI serial: Suitable for conventional incandescent regulator/TRIAC. Tilt head.