















Spécifications (Luminaires de la série)

	Isolation électrique	CII
	Tension D` Alimentation (V)	180-250V
Hz	Fréquence (Hz)	50-60Hz
ϕ	Facteur de puissance (Cos fi)	$\geq 0,5$
	Atténuation	Oui

	Indice d'étanchéité IP	IP20
	Couleur du corps	Blanc
	Corps	AL

K	Température de couleur	4.000K
	CRI Indice de rendu des couleurs	≥ 80
	Angle d'ouverture	45°

	Dimensions	Ø94x31mm
	Position de montage	Empotrado Techo
	Inclination	25°

	Température de service	-5 +35
---	-------------------------------	--------

ϕ_{LUM}	Flux (lm)	498lm
--------------	------------------	-------

	Heures de vie	(L70B50>) 50.000h
---	----------------------	-------------------

Les références 

	W	ϕ_{LUM}	K					
171038	6,5W	498lm	4.000K	≥ 80	Blanc	$\varnothing 75-80$	$\varnothing 94 \times 31 \text{mm}$	Oui

Dimensions 

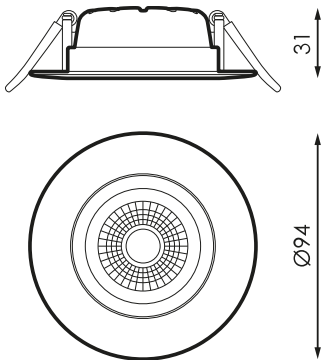

Photométrie 

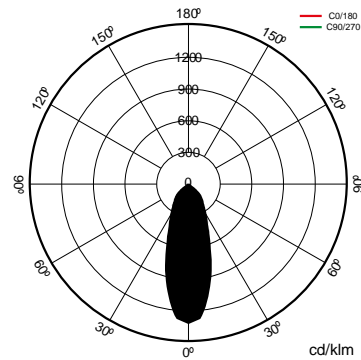

Sur demande



Kit d'urgence 1h



Dali



Pack BLUETOOTH

la description

Dispositif qui permet le contrôle du luminaire DALI via n'importe quel terminal Bluetooth® via une APP gratuite qui nous offre le contrôle de la régulation du débit, de la couleur, de la configuration de la scène, du comportement lié aux horaires.

Info

Pour plus d'informations sur les différentes solutions compatibles avec ce luminaire, consultez les codes BIDI suivants ou sur le web www.prilux.es

Info 

NAVI DIMMABLE en série: Suitable for conventional incandescent regulator/TRIAC. Tête pivotante.