











## Spécifications (Luminaires de la série)

	<b>Tension D` Alimentation (V)</b>	230V
Hz	<b>Fréquence (Hz)</b>	50-60Hz
$\Phi$	<b>Facteur de puissance (Cos fi)</b>	>0,57
	<b>Atténuation</b>	Non
	<b>Type de bague</b>	E27
	<b>Indice d'étanchéité IP</b>	IP20
K	<b>Température de couleur</b>	5.000K
	<b>CRI Indice de rendu des couleurs</b>	>80
	<b>Angle d'ouverture</b>	45°
	<b>Dimensions</b>	63x84mm
	<b>Température de service</b>	-5°C~+35 °C
$\Phi_{LUM}$	<b>Flux (lm)</b>	698lm
	<b>Heures de vie</b>	(L70B50>) 25.000h
	<b>CEE Classificationo énergétique</b>	A+

## Les références



	W	$\phi$	$\phi_{LUM}$	K	$\leftrightarrow$
<b>240970</b>	8W	>0,57	698lm	5.000K	63x84mm

## Dimensions



## Photométrie

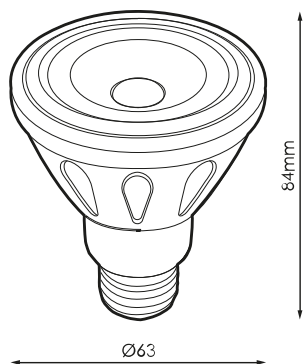

## Info



Jusqu'à épuisement des stocks