













## Specifications (Series luminaires)

	<b>Voltage (V)</b>	230V
Hz	<b>Frecuency (Hz)</b>	50-60Hz
$\Phi$	<b>Power factor (Cos fi)</b>	>0,5
	<b>Dimming</b>	No
	<b>Bushing type</b>	GU10
	<b>IP Tightness index</b>	IP20
K	<b>Colour temperature</b>	3.000K
	<b>CRI Colour rendering index</b>	>80
	<b>Opening angle</b>	100°
	<b>Measures</b>	50x58mm
	<b>Operating temperature</b>	-5°C~+35 °C
$\Phi_{LUM}$	<b>Flux (lm)</b>	578lm
	<b>Lifetime</b>	(L70B50>) 25.000h
	<b>CEE Energy classification</b>	F

## References



	W	$\phi$	$\phi_{LUM}$	K	$\leftrightarrow$
<b>378727</b>	7W	>0,5	578lm	3.000K	50x58mm

## Dimensions



## Photometry

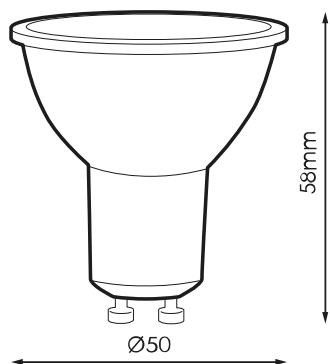

---

**Accessories**

---



---

**974851**

---

GU10/GZ10  
LAMPHOLDER WITH  
SILICONE CABLE