













Spécifications (Luminaires de la série)



	Tension D` Alimentation (V)	230V
Hz	Fréquence (Hz)	50-60Hz
Φ	Facteur de puissance (Cos fi)	>0,5
	Atténuation	Non
	Type de bague	GU10
	Indice d'étanchéité IP	IP20
K	Température de couleur	3.000K
	CRI Indice de rendu des couleurs	>80
	Angle d'ouverture	100°
	Dimensions	50x58mm
	Température de service	-5°C~+35 °C
Φ_{LUM}	Flux (lm)	578lm
	Heures de vie	(L70B50>) 25.000h
	CEE Classificationo énergétique	F

Les références



	W	ϕ	ϕ_{LUM}	K	\leftrightarrow
378727	7W	>0,5	578lm	3.000K	50x58mm

Dimensions



Photométrie

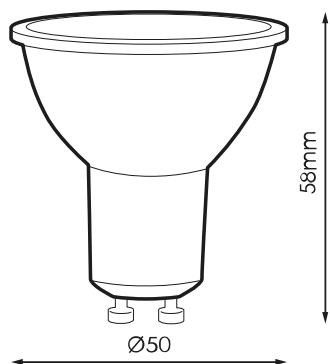

Accessoires



974851

DOUILLE HALOG. GU/
GZ10 C/C SILICONE