

















Specifications (Series luminaires)

	Electrical isolation	CCI
	Voltage (V)	230V
Hz	Frecuency (Hz)	50-60Hz
	Dimming	No
	Bushing type	GU10
	IP Tightness index	IP20
	Body color	White
K	Colour temperature	5000K
	CRI Colour rendering index	80cromatica
	Opening angle	100°
	Measures	50x58mm
	Flux (lm)	622lm
	Lifetime	(L70B50>)25.000h
	Lifetime	(L70B50>)25.000h
	N° of ignitions	15.000
	CEE Energy classification	A+

References



	W	ϕ_{LUM}	K	\leftrightarrow
378734	7W	622lm	5000K	50x58mm

Dimensions



Photometry

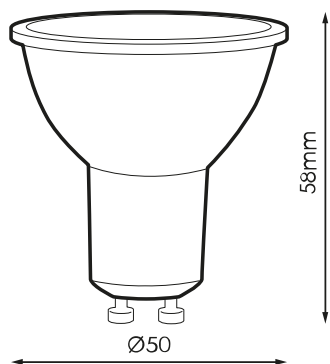

Accessories



974851

GU10/GZ10
LAMPHOLDER WITH
SILICONE CABLE