















## Spécifications (Luminaires de la série)

	<b>Tension D` Alimentation (V)</b>	230V
<b>Hz</b>	<b>Fréquence (Hz)</b>	50-60Hz
	<b>Atténuation</b>	Non
	<b>Type de bague</b>	GU10
	<b>Indice d'étanchéité IP</b>	IP20
<b>K</b>	<b>Température de couleur</b>	5.000K
	<b>CRI Indice de rendu des couleurs</b>	>80
	<b>Angle d'ouverture</b>	100°
	<b>Dimensions</b>	50x58mm
	<b>Température de service</b>	-5°C~+35 °C
	<b>Flux (lm)</b>	622lm
	<b>Heures de vie</b>	(L70B50>) 40.000h
	<b>CEE Classificatio no énergétique</b>	F

## Les références

	W	$\phi_{LUM}$	K	
<b>379489</b>	7W	622lm	5.000K	50x58mm

## Dimensions



## Photométrie

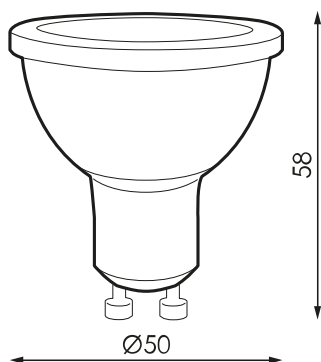

## Info



Jusqu'à épuisement des stocks

---

**Accessoires**

---



---

**974851**

---

DOUILLE HALOG. GU/  
GZ10 C/C SILICONE