















Spécifications (Luminaires de la série)

	Tension D` Alimentation (V)	230V
Hz	Fréquence (Hz)	50-60Hz
	Atténuation	Non
	Type de bague	GU10
	Indice d'étanchéité IP	IP20
K	Température de couleur	5.000K
	CRI Indice de rendu des couleurs	>80
	Angle d'ouverture	60°
	Dimensions	50x58mm
	Température de service	-5°C~+35 °C
	Flux (lm)	622lm
	Heures de vie	(L70B50>) 40.000h
	CEE Classificatio no énergétique	F

Les références

	W	ϕ_{LUM}	K	
379502	7W	622lm	5.000K	50x58mm

Dimensions



Photométrie

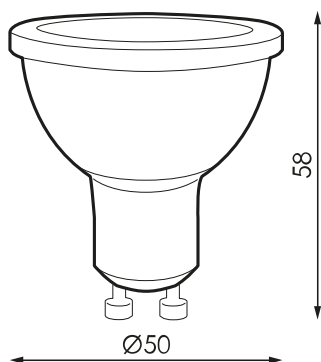

Info



Jusqu'à épuisement des stocks

Accessoires



974851

DOUILLE HALOG. GU/
GZ10 C/C SILICONE