



















## Specifications (Series luminaires)



	<b>Electrical isolation</b>	CII
	<b>Voltage (V)</b>	180-250V
	<b>Frecuency (Hz)</b>	50-60Hz
	<b>Dimming</b>	No
	<b>IP Tightness index</b>	IP20
	<b>Body color</b>	White
	<b>Diffuser Material</b>	PC-O
	<b>Body</b>	AL
	<b>Colour temperature</b>	3.000K
	<b>CRI Colour rendering index</b>	>80
	<b>Opening angle</b>	120°
	<b>Measures</b>	225x225x30mm
	<b>Mounting position</b>	Empotrado Techo
	<b>Operating temperature</b>	-5°C~+35 °C
	<b>Flux (lm)</b>	2.140lm
	<b>Lifetime</b>	(L70B50>) 50.000h

## References



	W	$\phi_{LUM}$	K					
<b>381406</b>	20W	2.140lm	3.000K	>80	White	200 x 200	225x225x30m	No

## Dimensions



## Photometry

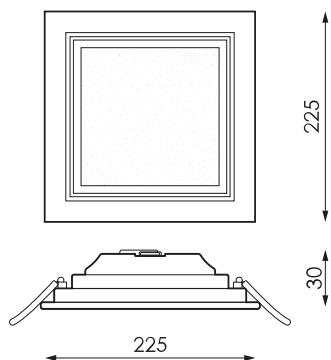



## On request



Emergency kit 2hBajo el campo de configuración se añade solo este texto, en los 4 idiomas definidos



Dali

## Accessories

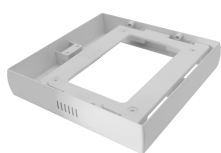

**387644**

SURFACE  
ACCESSORY SQ  
KENTAU 20W WHITE



**532181**

DRIVER KENTAU  
20W 1-10V



**507325**

DRIVER KENTAU  
20W DALI

---

## Technologies

---



---

### CELLTECH



CELLTECH technology is a revolutionary feeding system for luminaires that allow the extraction and exchange of drivers that facilitates and simplifies the installation and mounting of luminaires. CELLTECH drivers are available without regulation and with 1-10V regulation and C-TOUCH.

---



## Solutions

S



### CTE Pack

#### description

Regulation for the contribution of natural light to comply with the requirements of the CTE. Independent control of two lines of dimmable DALI luminaires with sensor to install in a luminaire or surface box. Preconfigured for easy operation.



### CLASSROOMS Pack

#### description

Regulation by contribution of natural light and stand alone presence. Lighting control system to meet CTE requirements and optimize energy use by taking advantage of natural light and automatic shutdown in case of absence.



### BLUETOOTH Pack

#### description

Device that enables DALI luminaire control through any Bluetooth® terminal via free APP that offers us control of flow regulation, color, scene configuration, behavior linked to schedules.

#### Info

For more information on the different solutions compatible with this luminaire, consult the following BIDI codes or on the web [www.prilux.es](http://www.prilux.es)