

















## Especificaciones (Luminarias de Serie)

	<b>Aislamiento eléctrico</b>	CII
	<b>Tensión (V)</b>	180-250V
<b>Hz</b>	<b>Frecuencia (Hz)</b>	50-60Hz
	<b>Regulación</b>	No
	<b>IP Índice de estanqueidad</b>	IP20
	<b>Color cuerpo</b>	Blanco
	<b>Difusor</b>	PC-O
	<b>Cuerpo</b>	AL
<b>K</b>	<b>Temperatura de color</b>	3.000K
	<b>CRI Índice de repr. cromática</b>	>80
	<b>Ángulo de apertura</b>	120°
	<b>Dimensiones</b>	225x225x30mm
	<b>Posición de montaje</b>	Empotrado Techo
	<b>Temp. de funcionamiento</b>	-5°C~+35 °C
	<b>Flujo luminoso (lm)</b>	2.140lm
	<b>Vida útil</b>	(L70B50>) 50.000h

## Referencias



	W	$\phi_{LUM}$	K					
<b>381406</b>	20W	2.140lm	3.000K	>80	Blanco	200 x 200	225x225x30m	No

## Dimensiones

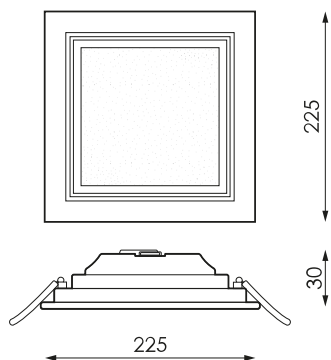

## Fotometría





## Bajo Pedido



Kit de emergencia 2h



DALI

## Accesorios

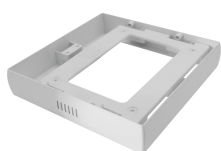

**387644**

ACCESORIO  
SUPERFICIE SQ  
KENTAU 20W  
BLANCO



**532181**

DRIVER KENTAU  
20W 1-10V



**507325**

DRIVER KENTAU  
20W DALI



## Tecnologías



### CELLTECH



La tecnología CELLTECH es un sistema revolucionario de alimentación de luminarias que permite la extracción y el intercambio de drivers que facilita y simplifica la instalación y montaje de luminarias. Los driver CELLTECH están disponibles sin regulación y con regulación 1-10V y C-TOUCH.



## Soluciones

S



### Pack CTE

#### descripción



Regulación por aporte de luz natural para cumplir con las exigencias del CTE. Control independiente de dos líneas de luminarias regulables DALI con sensor para instalar en luminaria o caja en superficie. Preconfigurado para poner en funcionamiento de manera sencilla.



### Pack AULAS

#### descripción



Regulación por aporte de luz natural y presencia stand alone. Sistema de control de iluminación para cumplir con las exigencias del CTE y optimizar el uso de la energía aprovechando el aporte de luz natural y apagado automático en caso de ausencia.



### Pack BLUETOOTH

#### descripción



Dispositivo que habilita el control de luminaria DALI a través de cualquier terminal Bluetooth® vía APP gratuita que nos ofrece el control de regulación de flujo, color, configuración de escenas, comportamiento vinculado a horarios.

#### Info



Para obtener más información de las diferentes soluciones compatibles con esta luminaria consulte en los siguientes códigos BIDI o en la web [www.prilux.es](http://www.prilux.es)