



















Specifications (Series luminaires)

	Electrical isolation	CII
	Voltage (V)	180-250V
	Frecuency (Hz)	50-60Hz
	Dimming	No
	IP Tightness index	IP20
	Body color	White
	Diffuser Material	PC-O
	Body	AL
	Colour temperature	3.000K
	CRI Colour rendering index	>80
	Opening angle	120°
	Measures	175x30mm
	Mounting position	Empotrado Techo
	Operating temperature	-5°C~+35 °C
	Flux (lm)	1.476lm
	Lifetime	(L70B50>) 50.000h

References



	W	ϕ_{LUM}	K					
381482	14W	1.476lm	3.000K	>80	White	150-155	175x30mm	No

Dimensions



Photometry

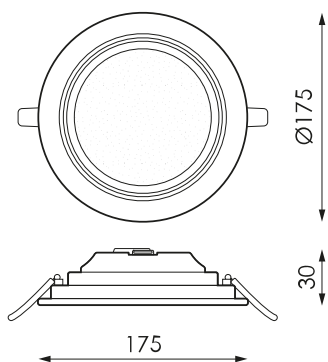

On request



Emergency kit 2hBajo el campo de configuración se añade solo este texto, en los 4 idiomas definidos



Dali

Accessories



387569

SURFACE
ACCESSORY CL
KENTAU 14W WHITE



532198

DRIVER KENTAU 14W
1-10V



543125

DRIVER KENTAU 14W
CTOUCH



507332

DRIVER KENTAU 14W
DALI



Technologies



CELLTECH



CELLTECH technology is a revolutionary feeding system for luminaires that allow the extraction and exchange of drivers that facilitates and simplifies the installation and mounting of luminaires. CELLTECH drivers are available without regulation and with 1-10V regulation and C-TOUCH.



Solutions

S



CTE Pack

description

Regulation for the contribution of natural light to comply with the requirements of the CTE. Independent control of two lines of dimmable DALI luminaires with sensor to install in a luminaire or surface box. Preconfigured for easy operation.



CLASSROOMS Pack

description

Regulation by contribution of natural light and stand alone presence. Lighting control system to meet CTE requirements and optimize energy use by taking advantage of natural light and automatic shutdown in case of absence.



BLUETOOTH Pack

description

Device that enables DALI luminaire control through any Bluetooth® terminal via free APP that offers us control of flow regulation, color, scene configuration, behavior linked to schedules.

Info

For more information on the different solutions compatible with this luminaire, consult the following BIDI codes or on the web www.prilux.es