













## Spécifications (Luminaires de la série)

	<b>Isolation électrique</b>	CII
	<b>Tension D` Alimentation (V)</b>	180-250V
<b>Hz</b>	<b>Fréquence (Hz)</b>	50-60Hz
$\phi$	<b>Facteur de puissance (Cos fi)</b>	$\geq 0,5$
	<b>Atténuation</b>	Oui

	<b>Indice d'étanchéité IP</b>	IP20
	<b>Couleur du corps</b>	9006
	<b>Corps</b>	AL

<b>K</b>	<b>Température de couleur</b>	4.000K
	<b>CRI Indice de rendu des couleurs</b>	$\geq 80$
	<b>Angle d'ouverture</b>	45°







	<b>Dimensions</b>	Ø94x31mm
	<b>Position de montage</b>	Empotrado Techo
	<b>Inclination</b>	25°

	<b>Température de service</b>	-5 +35
---	-------------------------------	--------

$\phi_{LUM}$	<b>Flux (lm)</b>	498lm
--------------	------------------	-------

	<b>Heures de vie</b>	(L70B50>) 50.000h
---	----------------------	-------------------

Les références 

	W	$\phi_{LUM}$	K					
412292	6,5W	498lm	4.000K	≥80	Gris 9006	Ø75-80	Ø94x31mm	Oui

Dimensions 

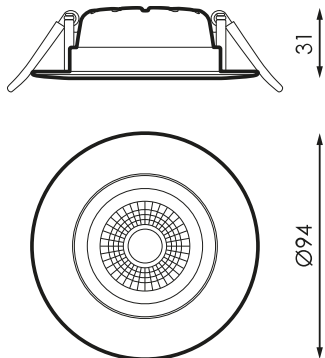

Photométrie 

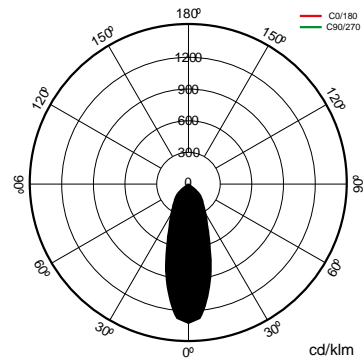

---

Sur demande

---



Kit d'urgence 1h



Dali



## Pack BLUETOOTH

### la description



Dispositif qui permet le contrôle du luminaire DALI via n'importe quel terminal Bluetooth® via une APP gratuite qui nous offre le contrôle de la régulation du débit, de la couleur, de la configuration de la scène, du comportement lié aux horaires.

### Info



Pour plus d'informations sur les différentes solutions compatibles avec ce luminaire, consultez les codes BIDI suivants ou sur le web [www.prilux.es](http://www.prilux.es)

**Info**



NAVI DIMMABLE en série: Suitable for conventional incandescent regulator/TRIAC. Tête pivotante.