



















Specifications

	Voltage (V)	230V ac
	Frecuency (Hz)	50-60
	IP Tightness index	65
	Body color	7010
	Diffuser Material	PC-P
	Body	AL
	Colour temperature	3.000K
	CRI Colour rendering index	>80
	Opening angle	100°
	Measures	158x134x28
	Operating temperature	-5°C~+35 °C
	Flux (lm)	1.576lm
	Electrical isolation	I
	Lifetime	(L70B50>) 25.000h
	L70 B10>(500<I≤1.000mA)	L70 >25.000h

References



	W	ϕ_{LUM}	K		
468350	20W	1.576lm	3.000K	7010	158x134x28

Dimensions

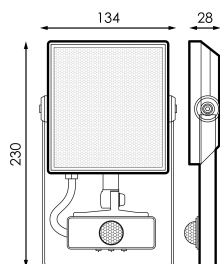

Photometry



Info



Until end of stock