

















## Spécifications (Luminaires de la série)

	<b>Isolation électrique</b>	CI
	<b>Tension D` Alimentation (V)</b>	230V
<b>Hz</b>	<b>Fréquence (Hz)</b>	50-60Hz
	<b>Indice d'étanchéité IP</b>	IP65
	<b>Couleur du corps</b>	Toile grise
	<b>Matériau du diffuseur</b>	PC-P
	<b>Corps</b>	AL
<b>K</b>	<b>Température de couleur</b>	3.000K
	<b>CRI Indice de rendu des couleurs</b>	>80
	<b>Angle d'ouverture</b>	100°
	<b>Dimensions</b>	158x134x28mm
	<b>Température de service</b>	-5°C~+35 °C
	<b>Flux (lm)</b>	1.438lm
	<b>Heures de vie</b>	(L70B50>) 25.000h

**Les références**



	W	$\phi_{LUM}$	K		
<b>468350</b>	20W	1.438lm	3.000K	Toile grise	158x134x28mm

**Dimensions**

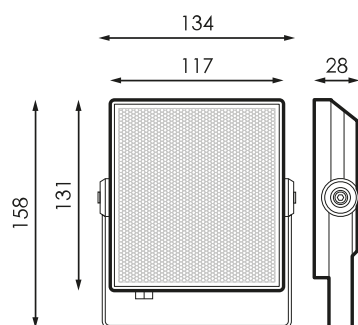

**Photométrie**



**Info**



Jusqu'à épuisement des stocks