

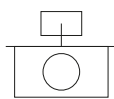

MADE IN SPAIN
Design by PRILUX



Aplicaciones



Despachos

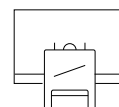

Aulas



Retail



Hogar

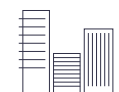

Grandes Superficies



Hoteles











Restaurantes







Cuidado de la salud

Especificaciones (Luminarias de Serie)



	Tensión (V)	220-240V
Hz	Frecuencia (Hz)	50-60Hz
	Intensidad (A)	390mA
ϕ	Factor de potencia (Cos fi)	0.93
	Número de leds	72
	Regulación	No
	IP Índice de estanqueidad	IP20
	Color cuerpo	9006
	Difusor	PC-O
	Cuerpo	AL
K	Temperatura de color	4.000K
	CRI Índice de repr. cromática	>80

	Dimensiones	1.136x85x80mm
	Posición de montaje	Superficie Pared
ϕ_{LUM}	Flujo luminoso (lm)	2.400lm
	Aislamiento eléctrico	Cl
	Vida útil	L70>50.000h

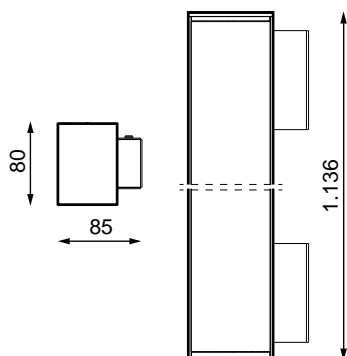

Prilux garantiza una tolerancia $\pm 10\%$ en las medidas de flujo lumínico.

Dimensiones



Referencias



	W_{LED}	W		ϕ_{LED}	ϕ_{LUM}	K	
482363	30W	32W	390mA	3.945lm	2.400lm	4.000K	1.136x85x80mm

Fotometría

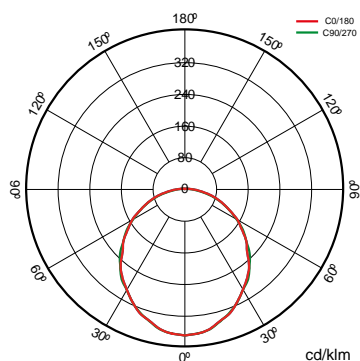

Bajo Pedido



Sensor de presencia y luminosidad



DALI

Bluetooth

K

WAS

>80 3.000K

>80 5.000K

>80 6.500K



Disponible colores RAL (Consultar)



Soluciones

S



Pack CTE

descripción



Regulación por aporte de luz natural para cumplir con las exigencias del CTE. Control independiente de dos líneas de luminarias regulables DALI con sensor para instalar en luminaria o caja en superficie. Preconfigurado para poner en funcionamiento de manera sencilla.



Pack Bluetooth

descripción



Versión de nuestras luminarias con comunicación Bluetooth Casambi que a través de cualquier terminal Bluetooth® vía APP gratuita nos ofrece el control de regulación de flujo, color, configuración de escenas, comportamiento vinculado a horarios. Múltiples accesorios pueden configurarse para funcionar en la misma red para unificar el control de uno o varios espacios, siendo posible crear grupos, escenas y secuencias dinámicas a medida. El dispositivo Bluetooth® es válido para cualquier luminaria DALI.



WAS Indoor

descripción



La solución WAS INDOOR está especialmente orientada a hospitales, residencias geriátricas, centros de wellness, aulas, despachos en los que aumenta el bienestar del usuario. En centros de trabajo la iluminación circadiana se aplica para mejorar las condiciones visuales, la comodidad y el rendimiento de los trabajadores, lo que afecta de manera directa a su productividad, lo cual repercute de manera muy positiva al desarrollo de la empresa.

Info



Para obtener más información de las diferentes soluciones compatibles con esta luminaria consulte en los siguientes códigos BIDI o en la web www.prilux.es

Info 

Necesita driver DALI