

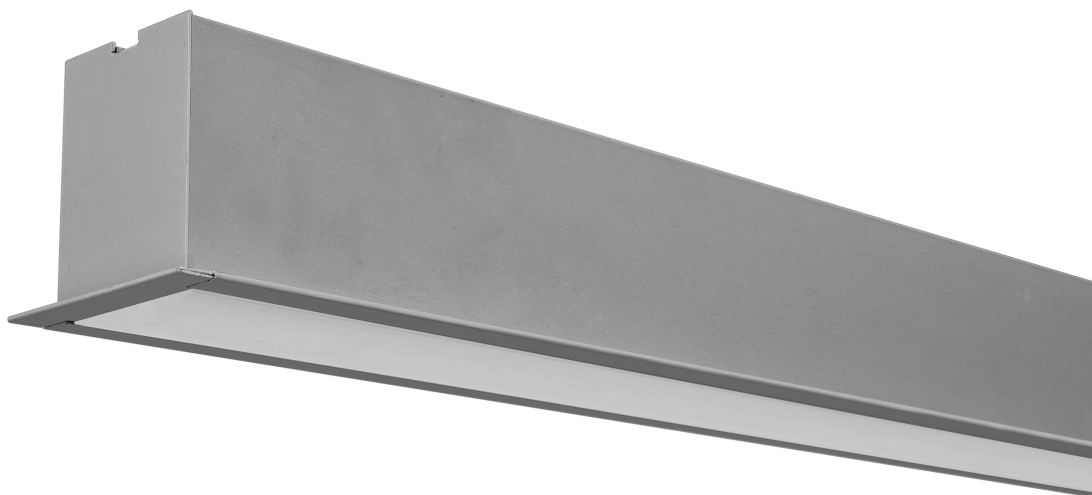

MADE IN SPAIN
Design by PRILUX

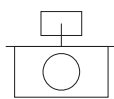

Applications



Offices

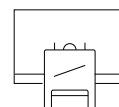

Classrooms



Retail



Home



Large surfaces



Hotels

















Restaurants



Health care

Specifications (Series luminaires)

	Voltage (V)	220-240V
Hz	Frecuency (Hz)	50-60Hz
	Current (A)	390mA
ϕ	Power factor (Cos fi)	0.93
	LED number	72
	Dimming	No
	IP Tightness index	IP20
	IK Impact resistance	IK08
	Body color	9006
	Diffuser Material	PC-O
	Body	AL
K	Colour temperature	4.000K
	CRI Colour rendering index	>80



	Measures	1.154x80x80mm
	Mounting position	Empotrar
ϕ_{LUM}	Flux (lm)	2.400lm
	Electrical isolation	CI
	Lifetime	L70>50.000h

Prilux guarantees a $\pm 10\%$ tolerance in light flux measurements.

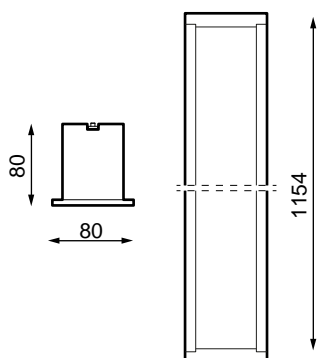
Dimensions



References

	W_{LED}	W		ϕ_{LED}	ϕ_{LUM}	K	
490405	30W	32W	390mA	3.945lm	2.400lm	4.000K	1.154x80x80mm

Photometry

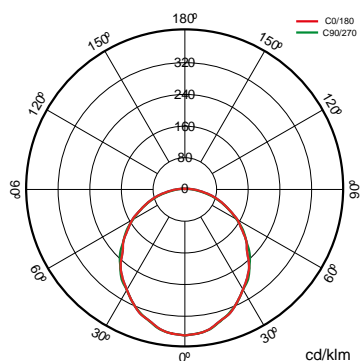

On request

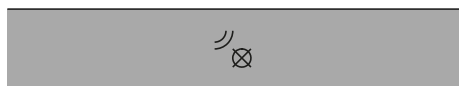

Presence and brightness sensor (mod.
1x/2x 1.200mm/1.500mm)



Dali

Bluetooth

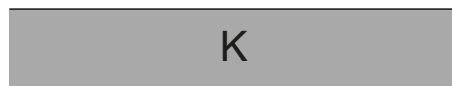

WAS(*Not compatible for 37W luminaires)

>80 3.000K

>80 4.000K

>80 4.000K



Available RAL colors (Consult)

Solutions

S



CTE Pack

description

Regulation for the contribution of natural light to comply with the requirements of the CTE. Independent control of two lines of dimmable DALI luminaires with sensor to install in a luminaire or surface box. Preconfigured for easy operation.



Was Indoor

description

The WAS INDOOR solution is specifically aimed at increasing the well-being of users in places such as hospitals, nursing homes, wellness centres, classrooms and offices. The circadian lighting is applied in workplaces to improve visual conditions, comfort and the workers' performance, resulting in a higher productivity and a better development of the company.



Bluetooth package

description

Casambi version of our fixtures that enables through any Bluetooth® terminal via free APP that offers the control of flow regulation, color, scene configuration, behavior linked to schedules. Multiple accessories can be configured to work on the same network to unify the control of one or more spaces, being able to create groups, scenes and dynamic sequences to measure. The Bluetooth® device is valid for any DALI luminaire.

Info

For more information on the different solutions compatible with this luminaire, consult the following BIDI codes or on the web www.prilux.es

Info 

You need DALI drive