

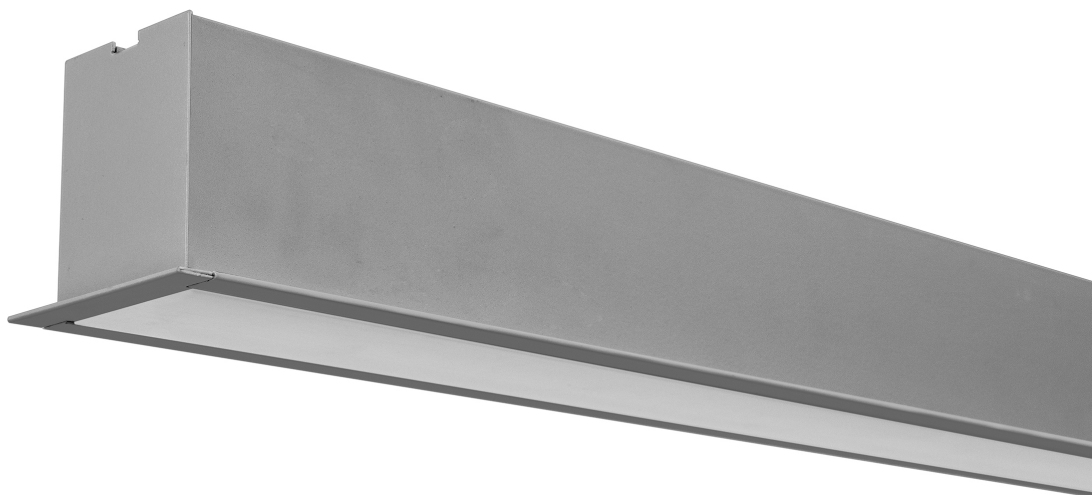

MADE IN SPAIN
Design by PRILUX

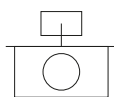

Formulários



Escritórios

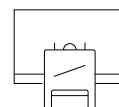

Salas de aula



Retalho



Início



Grandes superfícies



Hotéis

















Restaurantes



Cuidados de saúde

Especificações (Luminárias da série)

	Tensão (V)	220-240V
Hz	Frequência (Hz)	50-60Hz
	Intensidade (A)	390mA
ϕ	Fator de Potência (Cos fi)	$\geq 0,9$
	Número de leds	72
	Regulação	Não
	Índice de estanqueidade IP	IP20
	Cor do corpo	9006
	Material Difusor	PC-O
	Corpo	AL
K	Temperatura de cor	4000K
	CRI Índice de repr. cromática	80cromatica



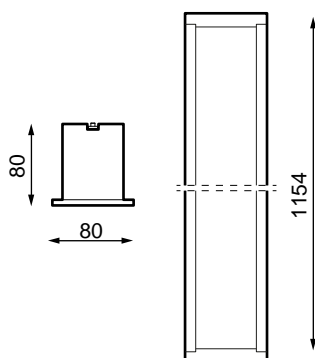

	Dimensão	1.154x80x80mm
	Posição de montagem	Superfície
ϕ_{LUM}	Fluxo (lm)	2400lm
	Isolamento elétrico	CCI
	Vida	L70>50000h
	Vida	L70 >50000h

Prilux garante uma tolerância de $\pm 10\%$ nas medições de fluxo de luz.

Dimensões



Referências

	W_{LED}	W		ϕ_{LED}	ϕ_{LUM}	K		
490405	30W	32W	390mA	3945lm	2400lm	4000K	1.154x80x80mm	80cromatica

Fotometria

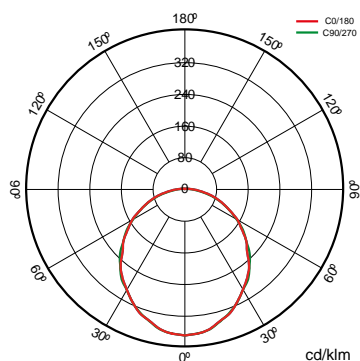

A pedido

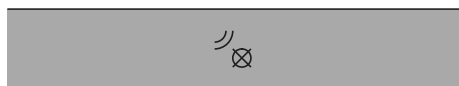

Presença e sensor de luz (mod. 1x/2x 1.200mm/1.500mm)



Dali

Bluetooth

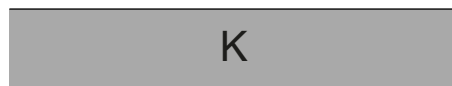

K

WAS(*Não compatível para luminárias de 37W)

>80 3.000K

>80 4.000K

>80 4.000K



Cores RAL disponíveis (Consultar)



Soluções

S



Pacote CTE

descrição



Regulamento de contribuição da luz natural para atendimento aos requisitos do CTE. Controlo independente de duas linhas de luminárias DALI reguláveis com sensor para instalar numa luminária ou caixa de superfície. Pré-configurado para fácil operação.



Pacote BLUETOOTH

descrição



Dispositivo que permite o controlo da luminária DALI através de qualquer terminal Bluetooth® via APP gratuito que nos oferece controlo de regulação de fluxo, cor, configuração de cena, comportamento vinculado a horários.



Was Indoor

descrição



A solução WAS INDOOR está especialmente orientada para hospitais, residências geriátricas, centros de bem estar, salas de aula, escritórios nos quais se incrementa o bem estar do utilizador. Nos centros de trabalho a iluminação circadiana aplica-se para melhorar as condições visuais, acomodidade e o rendimento dos trabalhadores, o que influencia de modo directo a sua produtividade, que se repercute de modo muito positivo no desenvolvimento da empresa.

Informacje



Para mais informações sobre as diferentes soluções compatíveis com esta luminária, consulte os seguintes códigos BIDI ou na web www.prilux.es

Informacje	
Necesita driver DALI	