

MADE IN SPAIN  
Design by PRILUX

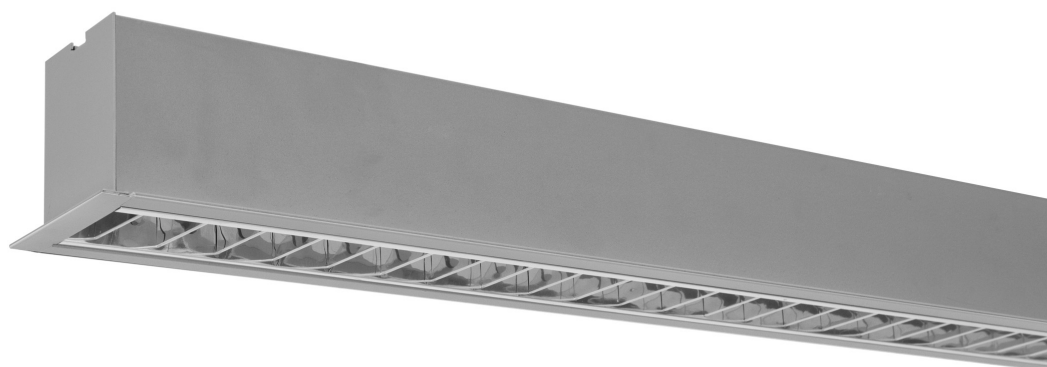

### Applications

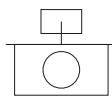

Bureaux

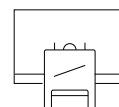

Salles de classe



Vente au détail



Accueil



Grandes surfaces



Hôtels



Restaurants









Soins de santé









## Spécifications (Luminaires de la série)



	<b>Tension D` Alimentation (V)</b>	220-240V
Hz	<b>Fréquence (Hz)</b>	50-60Hz
	<b>Intensité (A)</b>	390mA
$\phi$	<b>Facteur de puissance (Cos fi)</b>	0.93
	<b>Nombre de led</b>	72
	<b>Atténuation</b>	Non

	<b>Dimensions</b>	1.142x80x80mm
	<b>Position de montage</b>	Empotrar
$\phi_{LUM}$	<b>Flux (lm)</b>	2.286lm
	<b>Isolation électrique</b>	CI

	<b>Indice d'étanchéité IP</b>	IP20
	<b>IK Protection contre des impacts</b>	IK10
	<b>Couleur du corps</b>	9006
	<b>Matériau du diffuseur</b>	AL-SP
	<b>Corps</b>	AL

	<b>Heures de vie</b>	L70>50.000h
---	----------------------	-------------

K	<b>Température de couleur</b>	4.000K
	<b>CRI Indice de rendu des couleurs</b>	>80

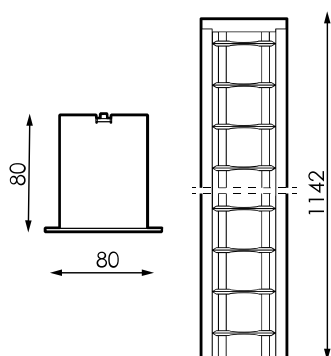

Prilux garantit une tolérance de  $\pm 10\%$  dans les mesures de flux lumineux.

## Dimensions



## Les références



	$W_{LED}$	W		$\phi_{LED}$	$\phi_{LUM}$	K	
490436	30W	32W	390mA	3.945lm	2.286lm	4.000K	1.142x80x80mm

## Photométrie

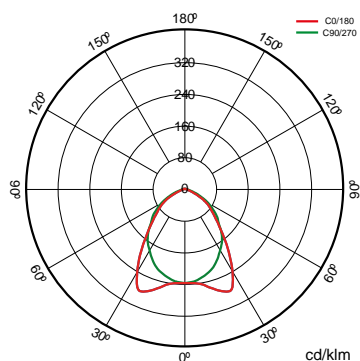

## Sur demande



Présence et capteur de lumière (mod.  
1x/2x 1.200mm/1.500mm)



Dali

Bluetooth

K

WAS(\*Non compatible avec les luminaires  
37W)

>80 3.000K

>80 4.000K

>80 4.000K



Couleurs RAL disponibles (Consulter)



## Solutions

S



### Pack CTE

#### la description



Règlement pour l'apport de lumière naturelle pour se conformer aux exigences du CTE. Commande indépendante de deux lignes de luminaires DALI gradables avec capteur à installer dans un luminaire ou un boîtier de surface. Préconfiguré pour une utilisation facile.



### Pack Bluetooth

#### la description



Version de nos luminaires avec communication Bluetooth Casambi qui via n'importe quel terminal Bluetooth® via APP gratuite qui offre le contrôle de la régulation de flux, la couleur, la configuration de la scène, le comportement lié aux horaires. Plusieurs accessoires peuvent être configurés pour travailler sur le même réseau pour unifier le contrôle d'un ou plusieurs espaces, être capable de créer des groupes, des scènes et des séquences dynamiques à mesurer. L'appareil Bluetooth® est valable pour tout luminaire DALI.



### Was Indoor

#### la description



La solution WAS INDOOR est destinée spécialement aux hôpitaux, résidences gériatriques, centres de bien-être, salles de cours, bureaux, où elle augmente le bien-être de l'utilisateur. Sur les lieux de travail, l'éclairage circadien est appliqué pour améliorer les conditions visuelles, le confort et le rendement des travailleurs, ce qui a un impact direct sur leur productivité et se répercute de façon très positive sur le développement de l'entreprise.

#### Info



Pour plus d'informations sur les différentes solutions compatibles avec ce luminaire, consultez les codes BIDI suivants ou sur le web [www.prilux.es](http://www.prilux.es)

## Info



Vous avez besoin d'un driver DALI