

MADE IN SPAIN
Design by PRILUX

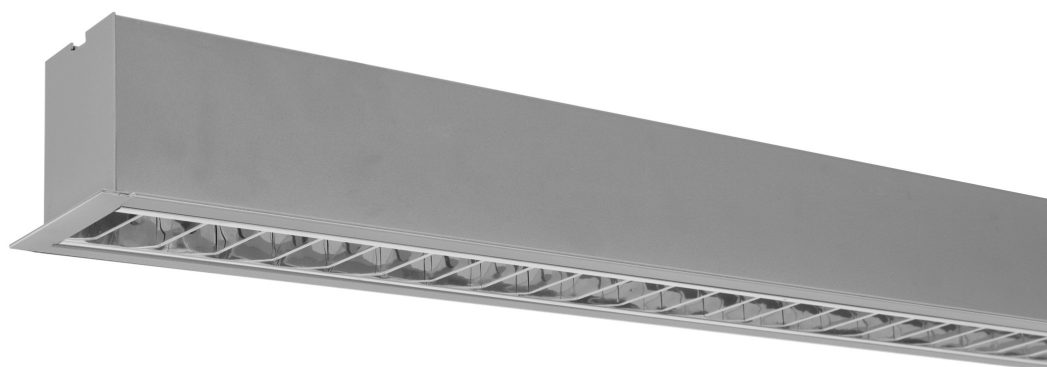

Applications

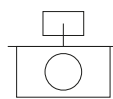

Bureaux

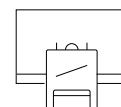

Salles de classe



Vente au détail



Accueil



Grandes surfaces



Hôtels

















Restaurants



Soins de santé

Spécifications (Luminaire de la série)

	Tension D` Alimentation (V)	220-240V
Hz	Fréquence (Hz)	50-60Hz
	Intensité (A)	390mA
ϕ	Facteur de puissance (Cos fi)	0.93
	Nombre de led	72
	Atténuation	Non
	Indice d'étanchéité IP	IP20
	IK Protection contre des impacts	IK08
	Couleur du corps	9006
	Matériau du diffuseur	AL-SP
	Corps	AL
K	Température de couleur	4.000K
	CRI Indice de rendu des couleurs	>80



	Dimensions	1.130x80x80mm
	Position de montage	Empotrar
ϕ_{LUM}	Flux (lm)	2.286lm
	Isolation électrique	CI
	Heures de vie	L70>50.000h

Prilux garantit une tolérance de $\pm 10\%$ dans les mesures de flux lumineux.

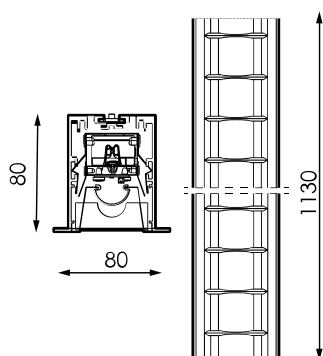
Dimensions



Les références

	W_{LED}	W		ϕ_{LED}	ϕ_{LUM}	K	
490450	30W	32W	390mA	3.945lm	2.286lm	4.000K	1.130x80x80mm

Photométrie

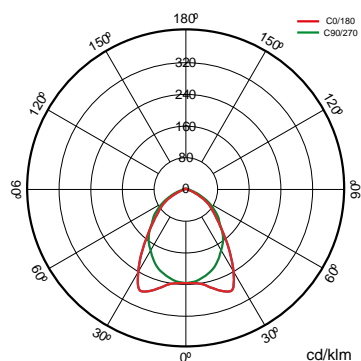

Sur demande



Présence et capteur de lumière (mod. 1x/2x 1.200mm/1.500mm)



Dali

Bluetooth

K

WAS(*Non compatible avec les luminaires 37W)

>80 3.000K

>80 4.000K

>80 4.000K



Couleurs RAL disponibles (Consulter)



Solutions

S



Pack CTE

la description



Règlement pour l'apport de lumière naturelle pour se conformer aux exigences du CTE. Commande indépendante de deux lignes de luminaires DALI gradables avec capteur à installer dans un luminaire ou un boîtier de surface. Préconfiguré pour une utilisation facile.



Was Indoor

la description



La solution WAS INDOOR est destinée spécialement aux hôpitaux, résidences gériatriques, centres de bien-être, salles de cours, bureaux, où elle augmente le bien-être de l'utilisateur. Sur les lieux de travail, l'éclairage circadien est appliqué pour améliorer les conditions visuelles, le confort et le rendement des travailleurs, ce qui a un impact direct sur leur productivité et se répercute de façon très positive sur le développement de l'entreprise.



Pack Bluetooth

la description



Version de nos luminaires avec communication Bluetooth Casambi qui via n'importe quel terminal Bluetooth® via APP gratuite qui offre le contrôle de la régulation de flux, la couleur, la configuration de la scène, le comportement lié aux horaires. Plusieurs accessoires peuvent être configurés pour travailler sur le même réseau pour unifier le contrôle d'un ou plusieurs espaces, être capable de créer des groupes, des scènes et des séquences dynamiques à mesurer. L'appareil Bluetooth® est valable pour tout luminaire DALI.

Info



Pour plus d'informations sur les différentes solutions compatibles avec ce luminaire, consultez les codes BIDI suivants ou sur le web www.prilux.es

Info 

Vous avez besoin d'un driver DALI