















Spécifications (Luminaires de la série)

	Isolation électrique	CI
	Tension D` Alimentation (V)	230V
Hz	Fréquence (Hz)	50-60Hz
ϕ	Facteur de puissance (Cos fi)	>0,5
	Indice d'étanchéité IP	IP65
	Couleur du corps	7045
	Matériau du diffuseur	VT-O
	Corps	AL
K	Température de couleur	3.000K
	CRI Indice de rendu des couleurs	>80
	Angle d'ouverture	100°
	Dimensions	109x90x27mm
ϕ_{LUM}	Flux (lm)	911lm
	Heures de vie	(L70B50>) 25.000h

Les références



	W	ϕ_{LUM}	K		
504638	10W	911lm	3.000K	Gris foncé	109x90x27mm

Dimensions

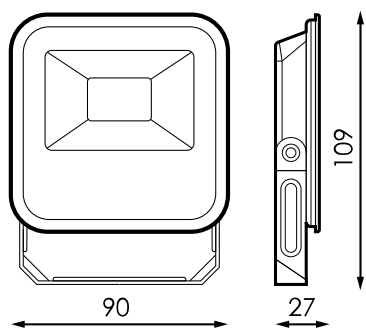

Photométrie

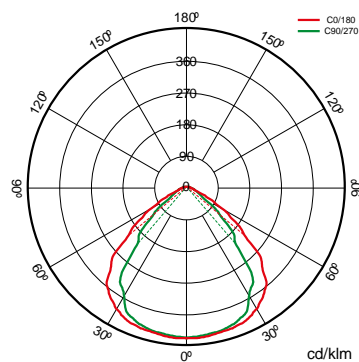

Info



Jusqu'à épuisement des stocks