













## Spécifications (Luminaires de la série)

	<b>Isolation électrique</b>	CI
	<b>Tension D` Alimentation (V)</b>	230V
<b>Hz</b>	<b>Fréquence (Hz)</b>	50-60Hz
$\phi$	<b>Facteur de puissance (Cos fi)</b>	>0,9
	<b>Indice d'étanchéité IP</b>	IP65
	<b>Couleur du corps</b>	7045
	<b>Matériau du diffuseur</b>	VT-O
	<b>Corps</b>	AL
<b>K</b>	<b>Température de couleur</b>	3.000K
	<b>CRI Indice de rendu des couleurs</b>	>80
	<b>Angle d'ouverture</b>	110°
	<b>Dimensions</b>	186x135x30mm
$\phi_{LUM}$	<b>Flux (lm)</b>	2.618lm
	<b>Heures de vie</b>	(L70B50>) 25.000h

**Les références**



	W	$\phi_{LUM}$	K		
<b>504676</b>	30W	2.618lm	3.000K	Gris foncé	186x135x30mm

**Dimensions**

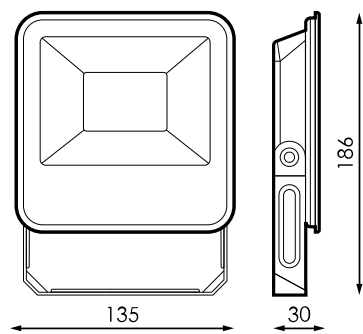

**Photométrie**

