















Especificaciones (Luminarias de Serie)

	Aislamiento eléctrico	CI
	Tensión (V)	230V
Hz	Frecuencia (Hz)	50-60Hz
	Factor de potencia (Cos fi)	>0,9
	IP Índice de estanqueidad	IP65
	Color cuerpo	7045
	Difusor	VT-O
	Cuerpo	AL
K	Temperatura de color	5.000K
	CRI Índice de repr. cromática	>80
	Ángulo de apertura	110°
	Dimensiones	186x135x30mm
	Flujo luminoso (lm)	2.743lm
	Vida útil	(L70B50>) 25.000h

Referencias



	W	ϕ_{LUM}	K		
504683	30W	2.743lm	5.000K	RAL7045	186x135x30mm

Dimensiones

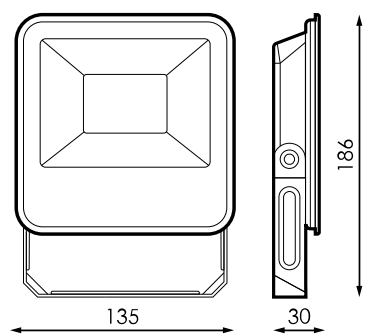

Fotometría

