











Especificaciones (Luminarias de Serie)

	Aislamiento eléctrico	CI
	Tensión (V)	230V
Hz	Frecuencia (Hz)	50-60Hz
	Factor de potencia (Cos fi)	>0,9

	IP Índice de estanqueidad	IP65
	Color cuerpo	7045
	Difusor	VT-O
	Cuerpo	AL

K	Temperatura de color	3.000K
	CRI Índice de repr. cromática	>80
	Ángulo de apertura	110°



	Dimensiones	287x243x37mm
---	--------------------	--------------

	Flujo luminoso (lm)	6.203lm
---	----------------------------	---------

	Vida útil	(L70B50>) 25.000h
---	------------------	-------------------

Referencias



	W	ϕ_{LUM}	K		
504713	70W	6.203lm	3.000K	RAL7045	287x243x37mm

Dimensiones

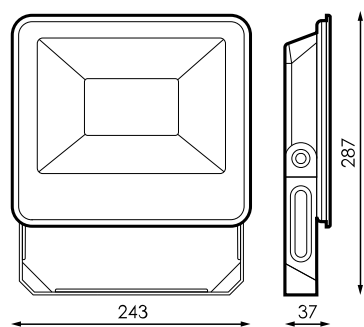

Fotometría

